



Bridgelux® Pallas-A Single Channel 60W (0-10V) Linear Driver

Product Data Sheet DS486

Product Feature Map

Bridgelux Pallas-A (0-10V) Single Channel 60W Driver provides dynamic constant current output for LED modules and arrays. This Driver interoperates with 0-10V standard lighting systems and protocols and allows for simple integration of Bridgelux's and all major brands White Arrays and Linear modules. Please visit www.bridgelux.com for more information.

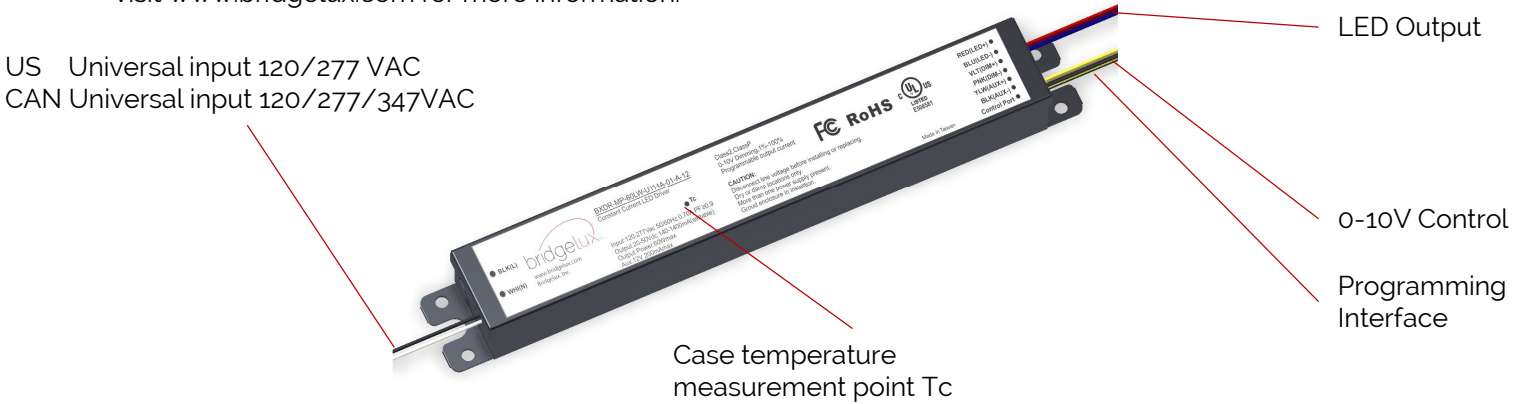

Product Nomenclature

The part number designation for Bridgelux Pallas-A (0-10V) Single Channel 60W Driver is explained as follows:

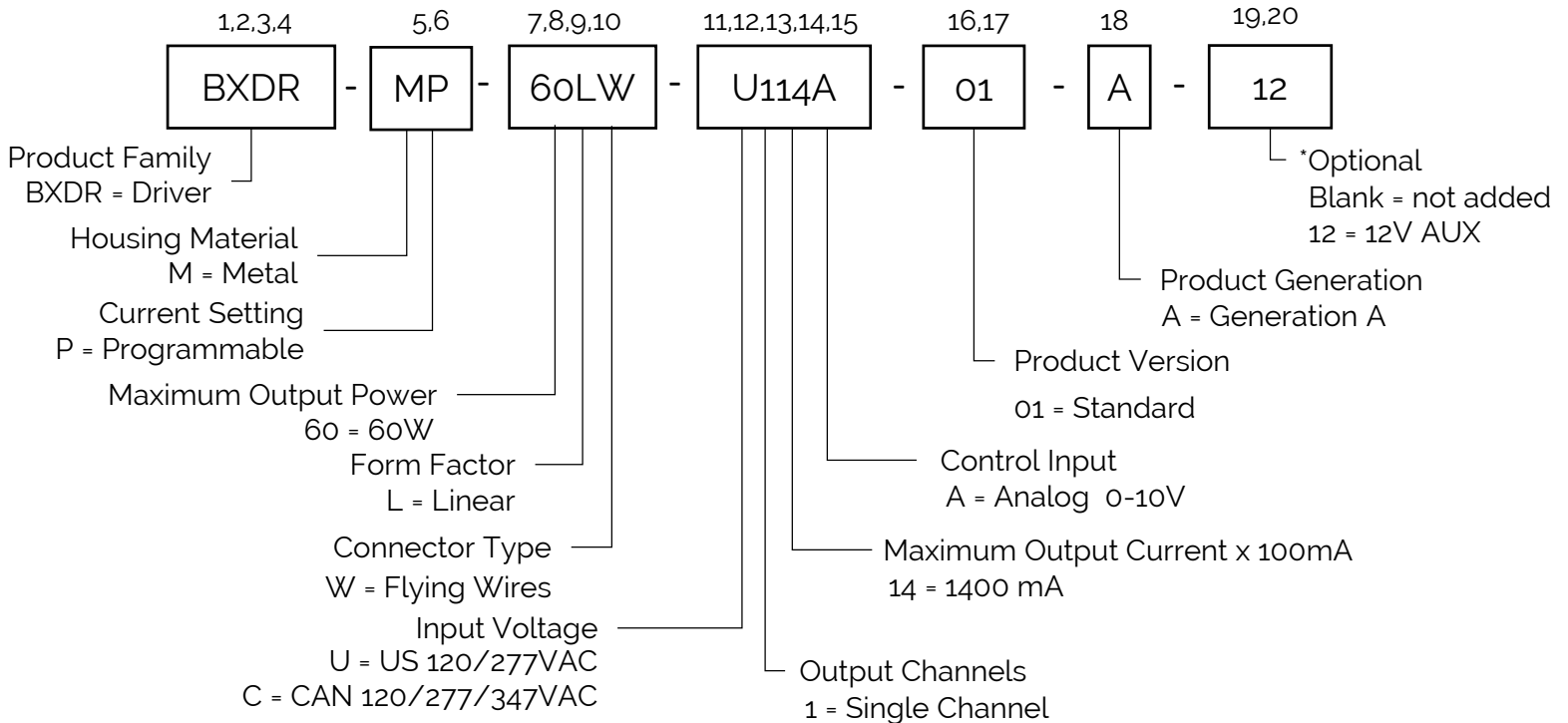

Table 1: **Product Selection Guide (examples)**

Part Number	Configuration
BXDR-MP-60LW-U114A-01-A	Linear, US Universal Input 120/270VAC
BXDR-MP-60LW-U114A-01-A-12	Linear, US Universal Input 120/277VAC, +12V AUX
BXDR-MP-60LW-C114A-01-A	Linear, CAN Universal Input 120/277/347VAC
BXDR-MP-60LW-C114A-01-A-12	Linear, CAN Universal Input 120/277/347VAC, +12V AUX

Electrical Characteristics

Table 2: Input Electrical Characteristics

Parameter	Unit	Specification
Nominal voltage	V	120 / 277 / 347 VAC
Nominal frequency	Hz	50 / 60 Hz
AC voltage range	V	108 – 382 VAC
Input current (max)	A	< 0.70 A (@ 120V) < 0.25 A (@ 277V) < 0.21 A (@ 347V)
THD (Full load)	%	< 10% (@ 120V) < 10% (@ 277V) < 15% (@ 347V)
Power factor (Full load)	-	> 0.95 (@ 120V) > 0.95 (@ 277V) > 0.90 (@ 347V)
Efficiency (Full load)	%	> 89% (@ 120V) > 89% (@ 277V) > 89% (@ 347V)
NO load	W	≤ 0.5 W
Inrush current(Cold start)	A pk	< 15A @ 120V input 25° C cold start at 100% conditions. For more details in the attached graph
Start-up Time	s	< 0.5 s

Table 3: Output Electrical Characteristics

Parameter	Unit	Specification
Nominal voltage range	V	20 – 50V (see Operating Window)
Maximum voltage(Open Circuit)	Vdc	≤ 60 V
Programmable Output Current	mA	140 – 1,400 mA
Current accuracy	%	+/- 5 %
Current ripple 100Hz	%	≤ 10 %
Pst LM	-	≤ 1
SVM	-	≤ 0.4
Output Power (Max)	W	60 W

Electrical Characteristics

Table 4: 0-10V / 1-10V Dimming Control Characteristics

Parameter	Unit	Specification
Dim+, Dim-	-	The 0~10V or resistor dimming can be used to dim the output current via a standard commercial wall dimmer (0~10VDC) or an external control voltage source (0~10VDC) or external resistor.
Dimming Curve	-	Linear (see "Dimming Curve")
Source Current on 0~10V Dimming Pin	-	200 – 500 μ A
Dimming Voltage for Full Bright	V	> 9.1V
External Resistor Value at Full Bright	Ω	45 k Ω

Figure 1: 0 – 10V Dimming Curve

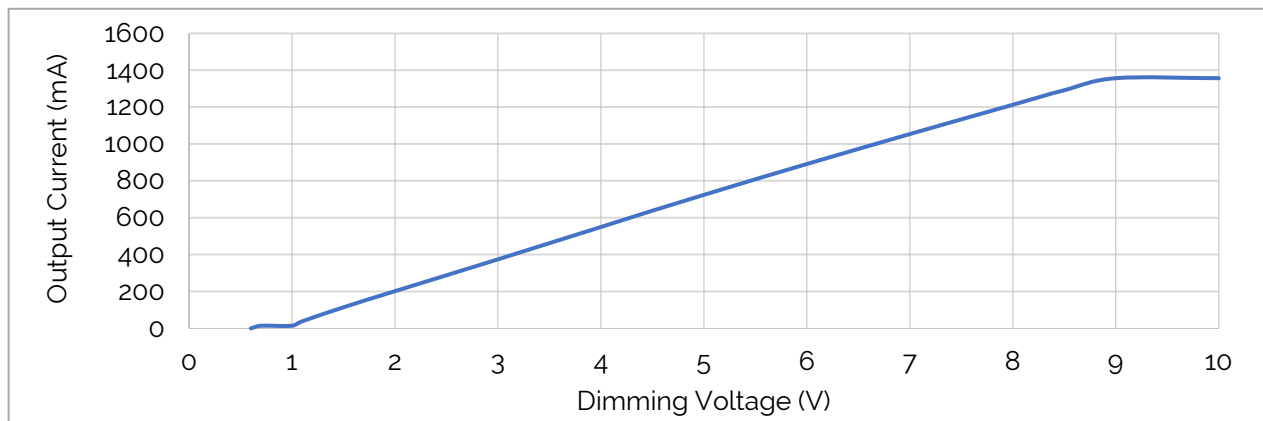
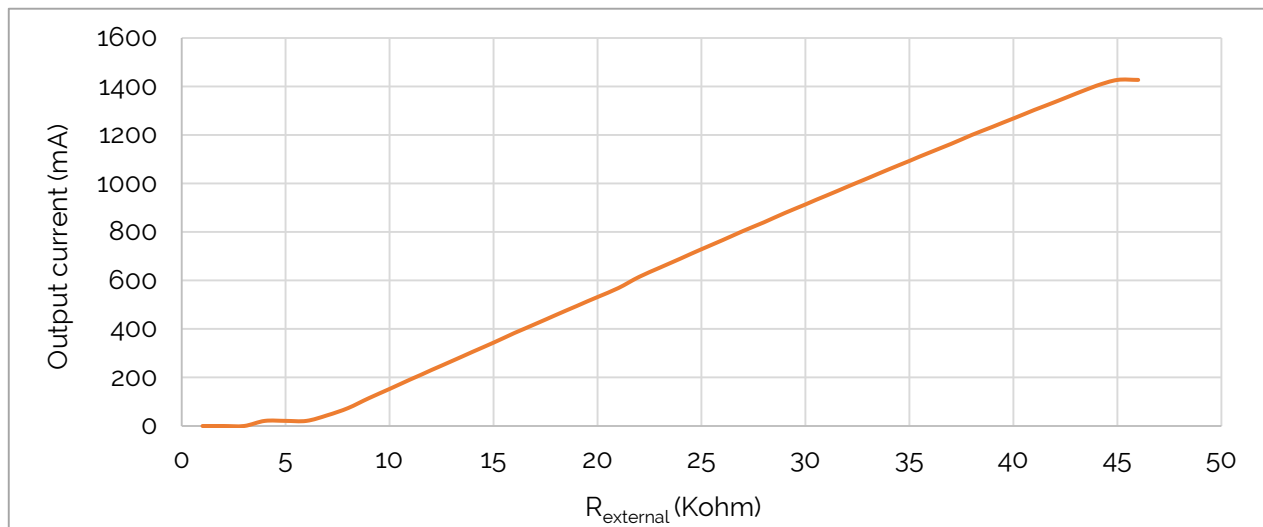

Figure 2: Resistance Dimming Curve



*Note: Same dimming curve characteristic applied to other programmed Output Current.

Electrical Characteristics

Figure 3: Operating Window

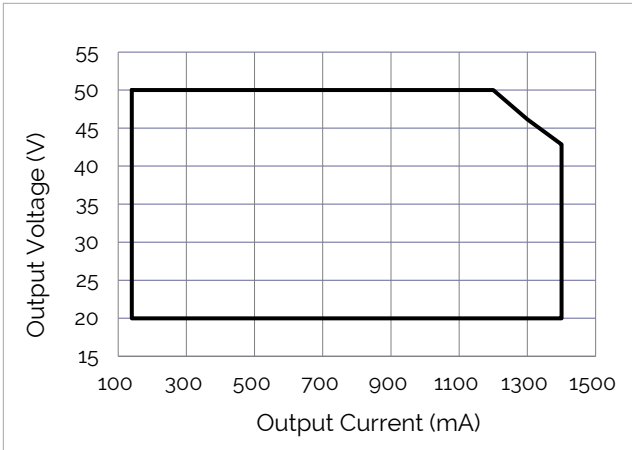

Figure 4: Power Factor vs. Output Power

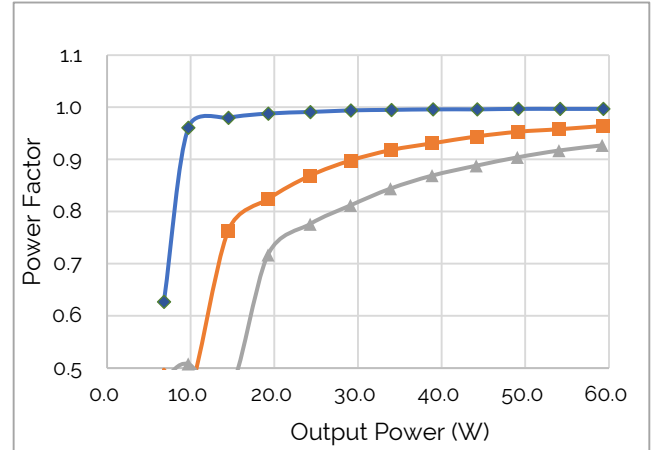

Figure 5: THD vs Output Power

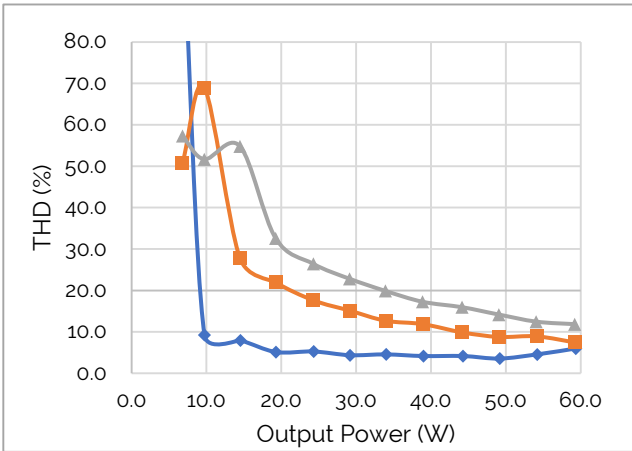

Figure 6: Input Current vs Output Power

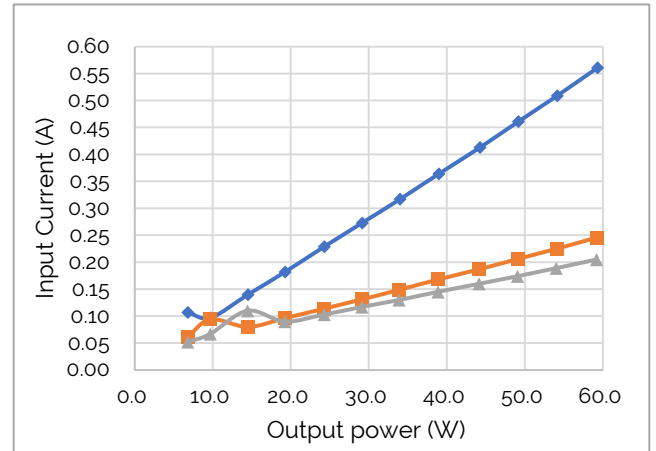
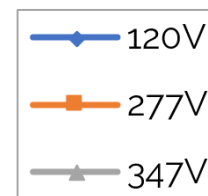
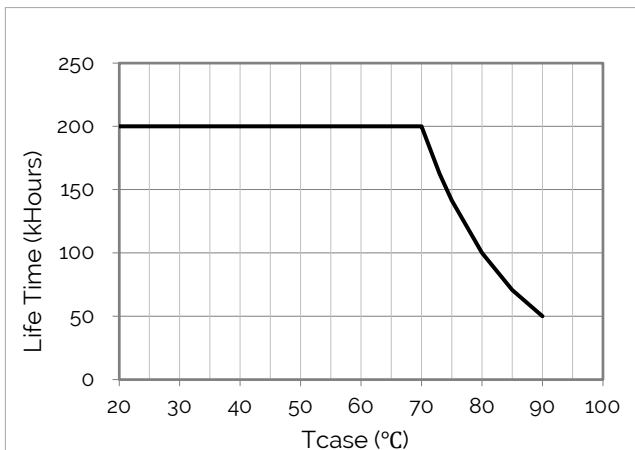

Figure 7: Estimated Lifetime vs Case Temperature



Electrical Characteristics

Figure 8: Efficiency @ 120VAC

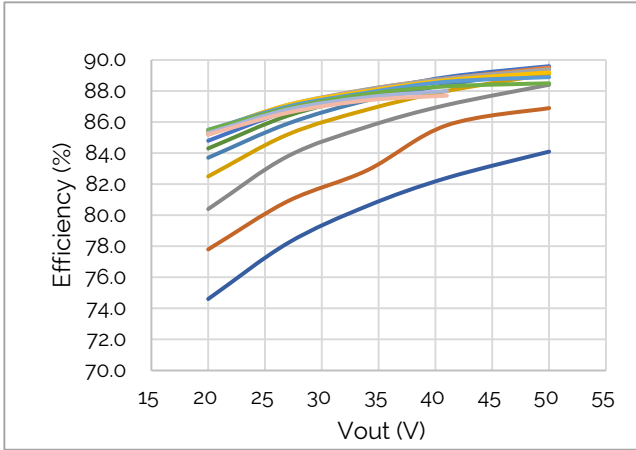

Figure 9: Efficiency @ 277VAC

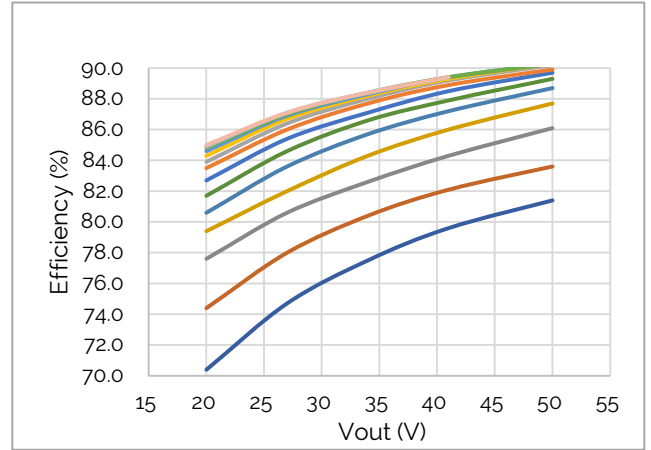
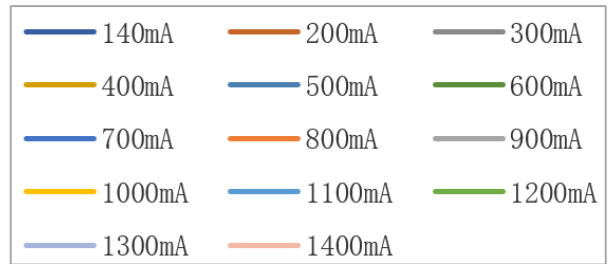
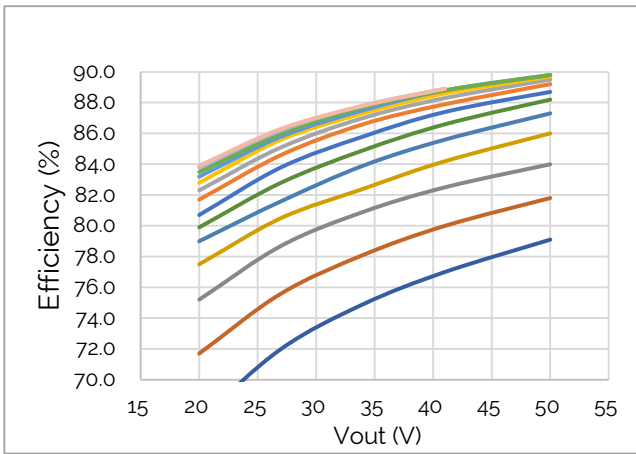

Figure 10: Efficiency @ 347VAC



Mechanical Characteristics

Table 5: Driver Mechanical Characteristics

Characteristics	Specification
Dimensions	241.3 mm (L) x 33.1 mm (W) x 28.0 mm (H)
Enclosure Materials	Steel Metal
Weight	420 g
Ingress Protection	IP20

Figure 11: Mechanical Drawing

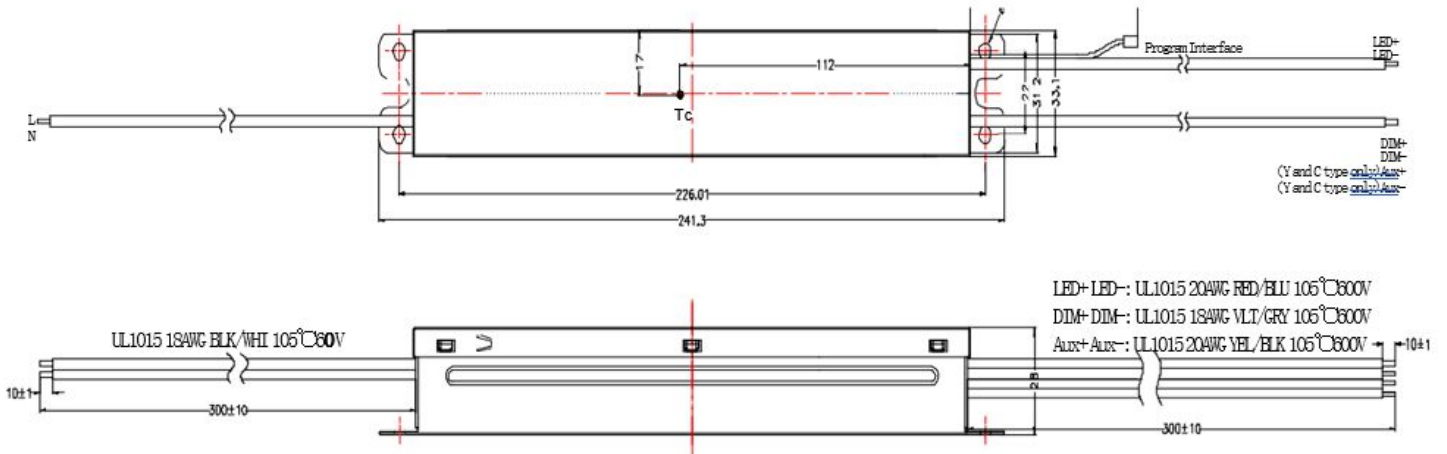

Notes for Figure 11:

1. Drawing dimensions are in millimeters
2. Unless otherwise specified, all linear tolerances are +/-1.0mm

Wiring Diagram

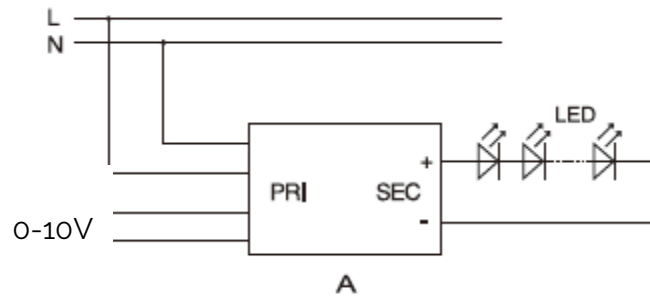

Table 6: **Wiring**

PRI / DIM	Cable AWG	AWG 18
	Cable Length	300 mm
SEC / AUX	Cable AWG	AWG 20
	Cable Length	300 mm

Notes for Table 6:

- Hot plug-in or secondary switching of LEDs is not permitted and may cause a very high current to the LEDs.
- Unless otherwise specified, all linear tolerances are +/-1.0mm

Auxiliary Source (Optional)

Table 7: **Auxiliary source 12V (Optional)**

Parameter	Unit	Specification
Voltage range	V	12V
Current Range	A	0.2A

Driver Programming

The Pallas-A Single Channel 60W Driver provides a programming port, which allows for programming specific driver settings in accordance with customer preferences. The Driver does not need to be powered during the programming of the driver settings. Bridgelux provides a programmer for programming the Pallas-A Single Channel Driver. For more information on the programmer, please see the Pallas-A Programmer data sheet on www.bridgelux.com or contact your local Bridgelux sales representative.

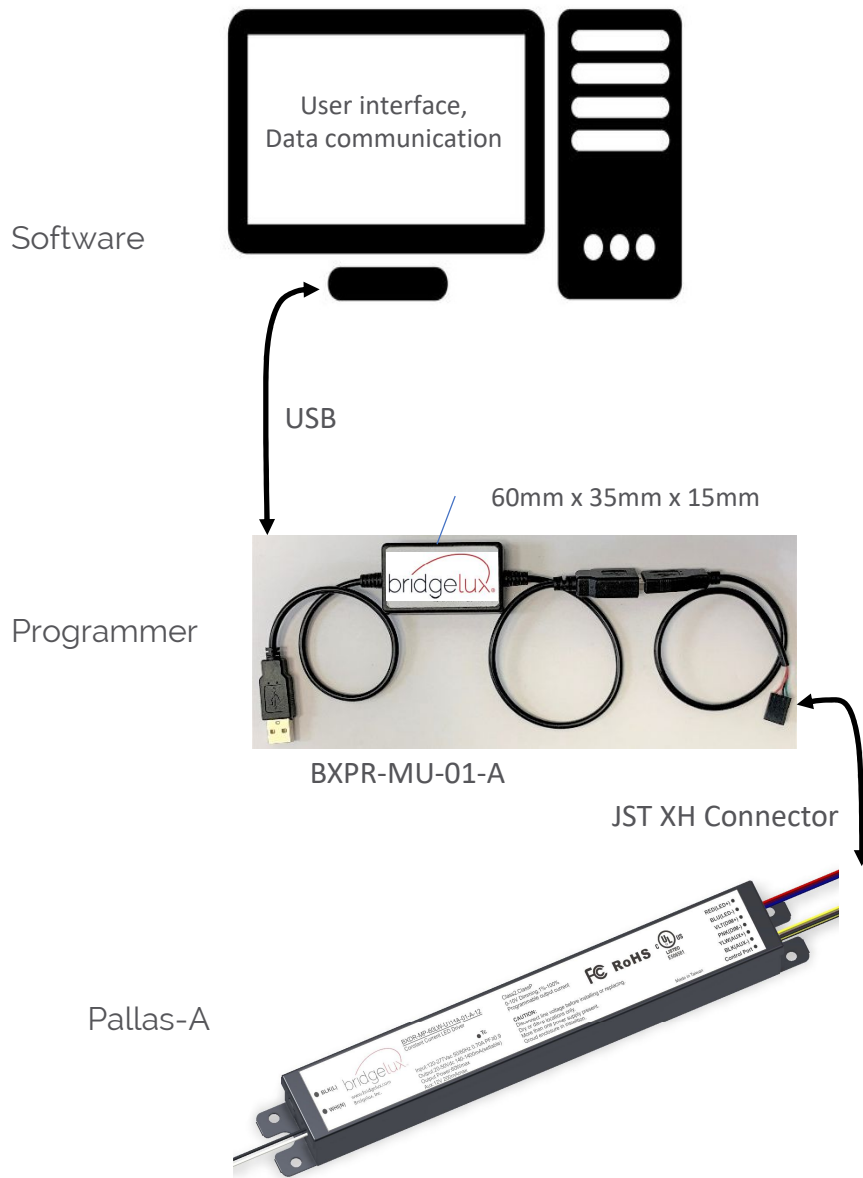

Programming Software (Bridgelux Driver Configuration)

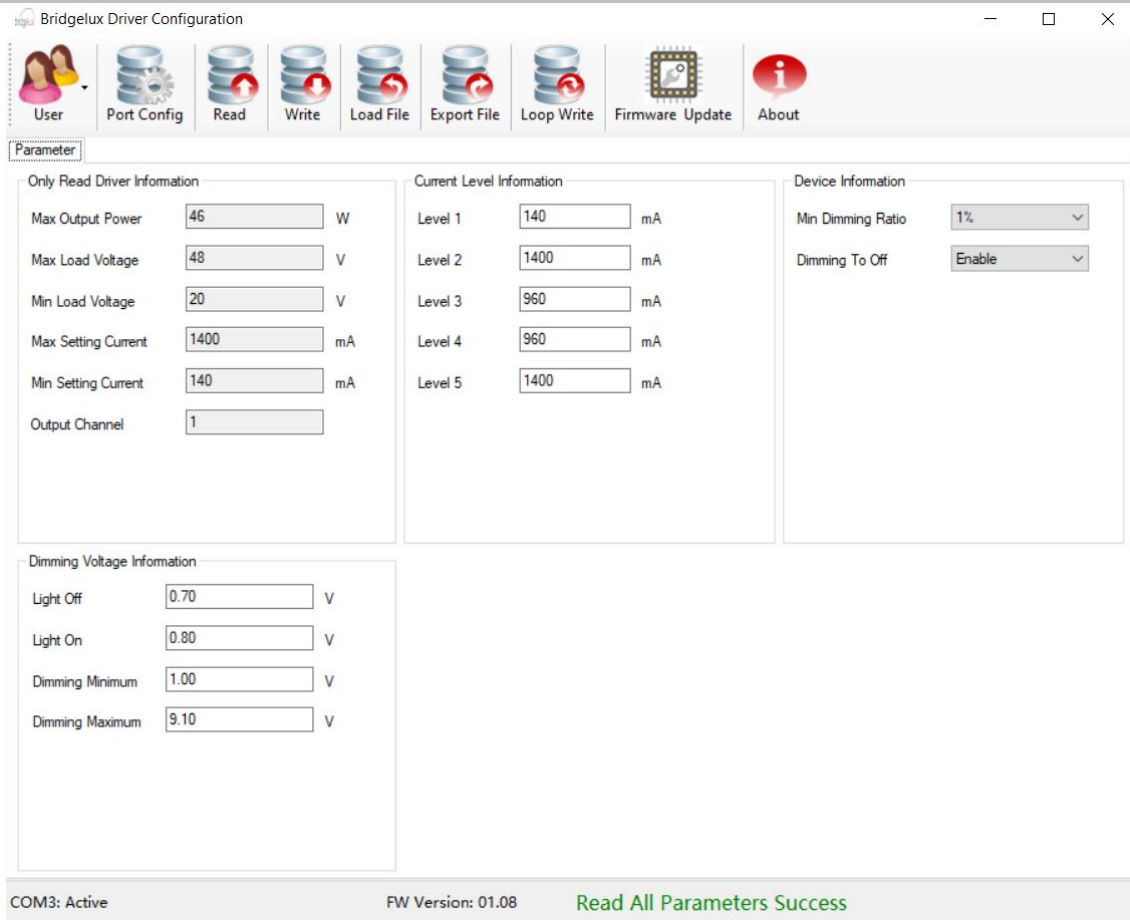

Support Features:

- 1mA Current Programmable Step
- Max. Current Setting for LEDs (Level 5 field; Level 1-4 reserved for Bridgelux R&D only)
- Minimum Dimming Ratio (1%, 5%, 10%)
- Dim-To-Off: (ON/OFF)

**Details please refer to "Bridgelux Driver Configuration Software User Manual"*

Environmental and Regulatory Standards

Table 8: Environmental Conditions

Parameter	Specification
Ambient Operating Temperature	-20°C to + 50°C
Max. Case Temperature Tc	+90°C (max)
Humidity Rating	Maximum 90% Relative Humidity, non condensing
Storage Temperature	-20°C to + 85°C
Acoustic Noise	< 24 dBA (measured from 1M w/o/dimmer)
Expected Lifetime	50,000 hours (Tc < 90°C)
Working Locations	Suitable for dry and damp locations
Warranty	5 Years (Tc < 90°C)

Table g: Regulatory Approvals and Compliance

Specification	Reference Standard	Condition
Conducted and Radiated EMI	FCC Title 47 Part 15B	Class B at 120VAC, Class A at 277VAC & 347VAC
Voltage Fluctuations & Flicker	IEC 61000-3-3:2013+A1:2019	
ESD (Electrostatic Discharge)	IEC 61547:2009 Section 5.2 Test des.: IEC 61000-4-2	6 kV contact discharge, 8 kV air discharge, level 3
Electrical Fast Transient	IEC 61547 Section 5.5 Test des.: IEC 61000-4-4	± 2kV Direct couple to Line input, 5kHz repetition rate, 15mS duration, 300mS period. 7 coupling paths, 1 minute per path (14 total combinations)
Surge Protection	IEC 61547 Section 5.7 Test des.: IEC 61000-4-5 or ANSI/IEEE C62.41-2002	± 2kV Common and Differential Mode, test at 2 Ω, 5 strikes/1minute interval (40 total strikes)
	ANSI/IEEE C62.41.1-2002	2.5kV Ring Wave, test at 30Ω 7 Strikes/1 minute interval, Commonand Differential mode, 56 total strikes
Voltage Dips	IEC 61547 Section 5.8, 5.9 Test des.: IEC 61000-4-11	>95% dip, .5 period; 30% dip, 25 periods; 95% reduction, 250 periods
Note: Unless otherwise specified, all the above parameters are measured at ambient temperature of 25°C and rated voltage.		

Regulatory Standards (continued)

Table 10: Safety Agency Approvals

Specification	Reference Standard	Condition
UL / cUL	UL8750, CAN/CSA-C22.2 No. 250.13	UL Listed, Class 2, Class P

Table 11: Protection

Specification	Reference Standard	Condition
Over Voltage Protection (OVP)	YES	Automatic recovery
Over Temperature Protection (OTP)	YES	Gradually reduce output power when Tc exceed 90°C. Automatic recovery
Output Short-Circuit Protection (SCP)	YES	Automatic recovery



Inrush Current

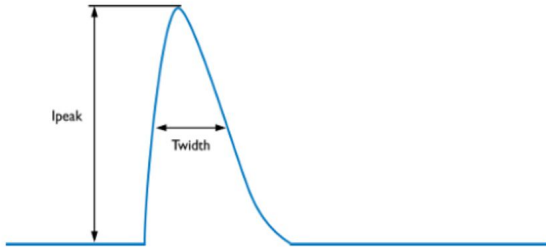

Input Voltage	I_{peak} (A)	Twidth (Time @50% of I_{peak})
120VAC	11.1 A	354 μ s
277VAC	25.5 A	316 μ s
347VAC	33.5 A	274 μ s

Table 12: Estimated Maximum Number of Drivers per Miniature Circuit Breaker (MCB)

Input Voltage	B10	C10	D10	B13	C13	D13	B16	C16	D16	B20	C20	D20
120VAC	10	12	14	14	16	18	17	20	23	21	25	29
277VAC	9	15	31	12	20	40	15	25	50	18	31	62
347VAC	8	13	26	10	17	34	12	21	42	16	26	53

Packaging

Table 13: Packaging Box Configuration

Parameters	Specification
Driver quantity	24 pcs
Outer dimensions	330 X 305 X 210 mm
Weight	11 kg

Figure 12: Packaging Box Design

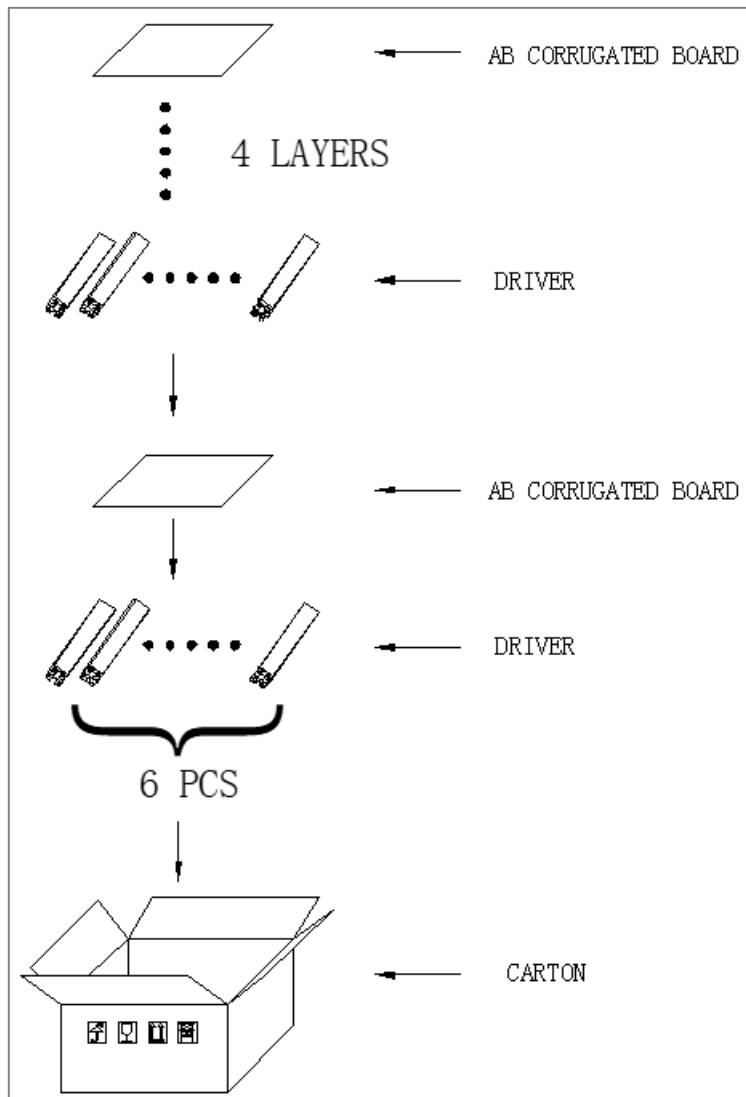

Notes for Figure 12:

1. Each box contains 4 layers with 6 drivers in each layer. Each layer is separated by horizontal dividers. There are 5 horizontal dividers per box.

Design Resources

Application Notes

Please contact your Bridgelux sales representative for assistance on obtaining application support when designing with the Bridgelux Pallas-A Single Channel Driver. For a list of available resources, visit www.bridgelux.com.

Precautions

CAUTION: PRODUCT HANDLING

Handle the Pallas-A Single Channel Driver with care to prevent any damage from mechanical shock. It is recommended to handle this driver in a static-free environment. Do not open or disassemble the product. To maintain product warranty, the installer is responsible for ensuring that the driver's operating conditions do not exceed the maximum conditions stated within this data sheet.

CAUTION: PRODUCT INSTALLATION

Incorrect installation of the Pallas-A Single Channel Driver can cause irreparable damage to the driver, connected LEDs. Pay attention when connecting the LED load and observe the correct polarity of the output terminals as specified in this data sheet and on the driver label.

CAUTION: ELECTRIC SHOCK

Be aware of the possibility of an electric shock hazard which can result in serious injury or death. Disconnect power before servicing or installing this device.

Disclaimers

MINOR PRODUCT CHANGE POLICY

The rigorous qualification testing on products offered by Bridgelux provides performance assurance. Slight cosmetic changes that do not affect form, fit, or function may occur as Bridgelux continues product optimization.

About Bridgelux: Bridging Light and Life™

At Bridgelux, we help companies, industries and people experience the power and possibility of light. Since 2002, we've designed LED solutions that are high performing, energy efficient, cost effective and easy to integrate. Our focus is on light's impact on human behavior, delivering products that create better environments, experiences and returns—both experiential and financial. And our patented technology drives new platforms for commercial and industrial luminaires.

For more information about the company, please visit

bridgelux.com

twitter.com/Bridgelux

facebook.com/Bridgelux

youtube.com/user/Bridgelux

linkedin.com/company/bridgelux

WeChat ID: BridgeluxInChina



46410 Fremont Blvd
Fremont, CA 94538 USA
Tel (925) 583-8400
www.bridgelux.com