



Bridgelux® Gen 7 Vero SE 10 Thrive™ Array

Product Data Sheet DS345



Introduction

Vero SE Thrive



Bridgelux Thrive™ combines unique chip, phosphor and packaging technology to closely match the spectra of natural light over the visible wavelength range. Thrive can be used in constant color point luminaires to bring full spectrum natural light indoors or in tunable white luminaires to incorporate circadian elements that may impact human well-being. The high fidelity spectral output of Thrive creates stunning environments with excellent color rendering and outstanding TM30 metrics. Thrive is available in both SMD components and LED arrays to enable a broad range of lighting applications including retail, hospitality, office, education, architectural, museums, healthcare and residential lighting.

Features

- Engineered spectrum to closely match natural light
- CRI >95, R1-R15 >90, high Rf and Rg values
- High efficacy full spectrum solution
- No violet chip augmentation
- Hot color targeted
- Form factor consistent with existing Bridgelux COB arrays
- Broad product platform availability (SMDs and COBs)

Benefits

- Full consistent spectrum with fewer spectral spikes
- Natural and vivid color rendering
- Greater energy savings, lower utility costs
- Economical, high efficiency solution
- Uniform and consistent white light at application conditions
- Ease of design and rapid go-to-market
- Enables greater design flexibility and platform color consistency



Contents

Product Feature Map	2
Product Nomenclature	2
Product Selection Guide	3
European Product Registry for Energy Labeling	5
Performance at Commonly Used Drive Currents	6
Spectrum Characteristics	9
Electrical Characteristics	12
Absolute Maximum Ratings	13
Eye Safety	14
Product Bin Definitions	15
Performance Curves	16
Typical Radiation Pattern	18
Mechanical Dimensions	19
Packaging and Labeling	20
Design Resources	22
Precautions	22
Disclaimers	22
About Bridgelux	23

Product Feature Map

Vero SE 10 is the smallest form factor in the product family of next generation solid state light sources. In addition to delivering the performance and light quality required for many lighting applications,

Vero SE incorporates several features to simplify the design integration and manufacturing process, accelerate time to market and reduce system costs. Please visit www.bridgelux.com for more information on the Vero SE family of products.

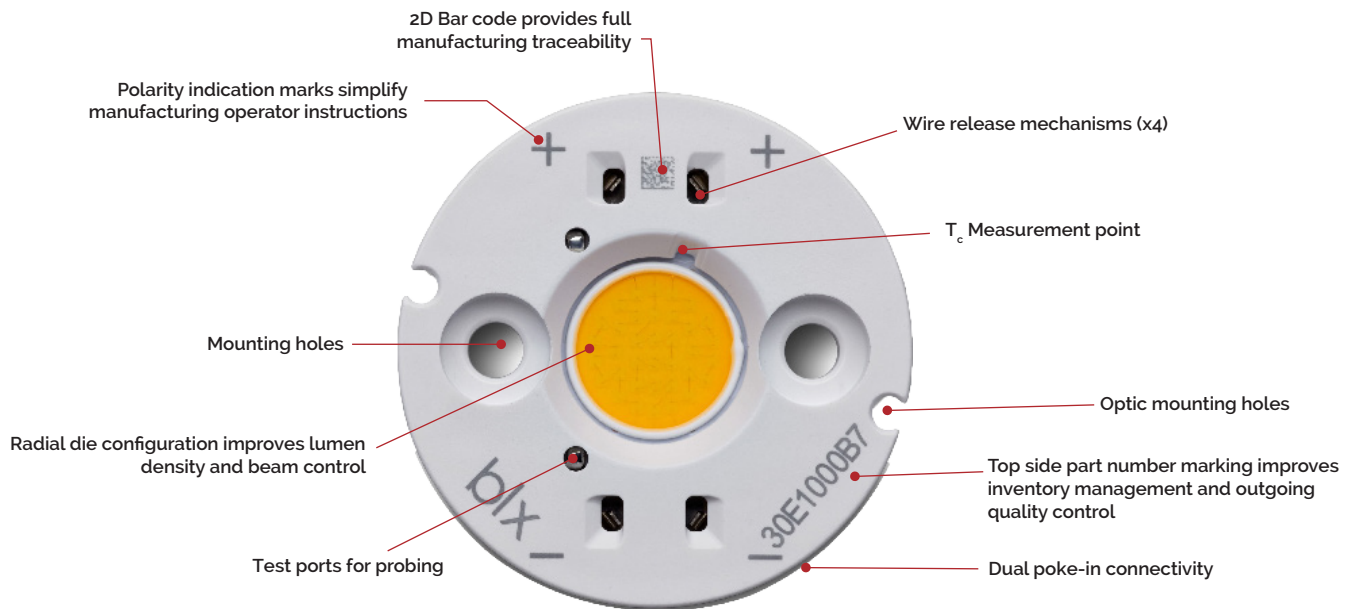

Product Nomenclature

The part number designation for Bridgelux COB arrays is explained as follows:

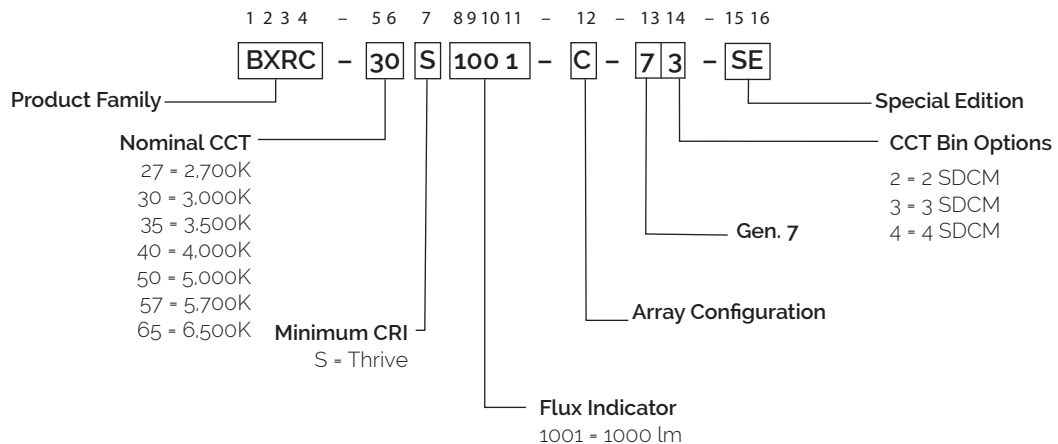

Product Selection Guide

The following product configurations are available:

Table 1: Selection Guide, Pulsed Measurement Data ($T_c = 25^\circ\text{C}$)

Part Number ^{1,6}	Nominal CCT ¹ (K)	CRI ²	Nominal Drive Current ³ (mA)	Typical V_f (V)	Typical Pulsed Flux ^{4,5,6,7} $T_c = 25^\circ\text{C}$ (lm)	Minimum Pulsed Flux ^{6,7,8} $T_c = 25^\circ\text{C}$ (lm)	Typical Power (W)	Typical Efficacy (lm/W)	Typical Photosynthetic Photon Flux (PPF)	Typical Photon Efficiency ($\mu\text{mol/J}$)
BXRC-27S1001-B-73-SE	2700	95	270	34.4	1003	858	9.3	108	17.5	1.9
BXRC-27S1001-C-73-SE	2700	95	360	34.4	1337	1144	12.4	108	23.33	1.9
BXRC-27S1001-D-73-SE	2700	95	360	25.8	975	858	9.3	105	17.46	1.88
BXRC-30S1001-B-73-SE	3000	95	270	34.4	1077	915	9.3	116	18.4	1.99
BXRC-30S1001-C-73-SE	3000	95	360	34.4	1437	1221	12.4	116	24.55	1.99
BXRC-30S1001-D-73-SE	3000	95	360	25.8	1040	915	9.3	112	17.95	1.93
BXRC-35S1001-B-73-SE	3500	95	270	34.4	1124	989	9.3	121	18.6	1.99
BXRC-35S1001-C-73-SE	3500	95	360	34.4	1498	1319	12.4	121	24.79	1.99
BXRC-35S1001-D-73-SE	3500	95	360	25.8	1156	1017	9.3	124	19.83	2.13
BXRC-40S1001-B-73-SE	4000	95	270	34.4	1142	1005	9.3	123	18.59	1.97
BXRC-40S1001-C-73-SE	4000	95	360	34.4	1523	1340	12.4	123	24.79	1.97
BXRC-40S1001-D-73-SE	4000	95	360	25.8	1207	1062	9.3	130	20.04	2.16
BXRC-50S1001-B-74-SE	5000	95	270	34.4	1198	1054	9.3	129	19.64	2.06
BXRC-50S1001-C-74-SE	5000	95	360	34.4	1598	1406	12.4	129	26.19	2.06
BXRC-50S1001-D-74-SE	5000	95	360	25.8	1260	1109	9.3	136	20.87	2.25
BXRC-57S1001-B-74-SE	5700	95	270	34.4	1226	1079	9.3	132	20.16	2.1
BXRC-57S1001-C-74-SE	5700	95	360	34.4	1635	1439	12.4	132	26.88	2.1
BXRC-57S1001-D-74-SE	5700	95	360	25.8	1271	1119	9.3	137	20.80	2.24
BXRC-65S1001-B-74-SE	6500	95	270	34.4	1207	1063	9.3	130	19.85	2.07
BXRC-65S1001-C-74-SE	6500	95	360	34.4	1610	1417	12.4	130	26.47	2.07
BXRC-65S1001-D-74-SE	6500	95	360	25.8	1239	1090	9.3	133	20.71	2.23

Notes for Table 1 :

- Product CCT is hot targeted at $T_j = 85^\circ\text{C}$. Nominal CCT as defined by ANSI C78.377-2011.
- All CRI values are measured at $T_j = T_c = 25^\circ\text{C}$. CRI values are minimums. Bridgelux maintains a ± 3 tolerance on CRI values.
- Drive current is referred to as nominal drive current.
- Products tested under pulsed condition (10ms pulse width) at nominal test current where T_j (junction temperature) = T_c (case temperature) = 25°C . Typical stabilized DC performance values are provided as reference only and are not a guarantee of performance.
- Typical performance values are provided as a reference only and are not a guarantee of performance.
- Typical performance is estimated based on operation under DC (direct current) with LED array mounted onto a heat sink with thermal interface material and the case temperature maintained at 85°C . Based on Bridgelux test setup, values may vary depending on the thermal design of the luminaire and/or the exposed environment to which the product is subjected.
- Bridgelux maintains a $\pm 7\%$ tolerance on flux measurements.
- Minimum flux values at the nominal test current are guaranteed by 100% test.

Product Selection Guide

The following product configurations are available:

Table 2: Selection Guide, Stabilized DC Test Performance ($T_c = 85^\circ\text{C}$)^{4,5,6}

Part Number ^{1,6}	Nominal CCT ¹ (K)	CRI ²	Nominal Drive Current ³ (mA)	Typical V_f (V)	Typical DC Flux ^{4,5,6,7} $T_c = 85^\circ\text{C}$ (lm)	Minimum DC Flux ^{6,7,8,9} $T_c = 85^\circ\text{C}$ (lm)	Typical Power (W)	Typical Efficacy (lm/W)	Typical Photosynthetic Photon Flux (PPF)	Typical Photon Efficiency ($\mu\text{mol/J}$)
BXRC-27S1001-B-73-SE	2700	95	270	33.7	903	772	9.1	99	15.76	1.9
BXRC-27S1001-C-73-SE	2700	95	360	33.7	1204	1029	12.1	99	21.01	1.9
BXRC-27S1001-D-73-SE	2700	95	360	25.3	888	781	9.1	98	15.79	1.74
BXRC-30S1001-B-73-SE	3000	95	270	33.7	970	823	9.1	107	16.57	1.99
BXRC-30S1001-C-73-SE	3000	95	360	33.7	1293	1098	12.1	107	22.09	1.99
BXRC-30S1001-D-73-SE	3000	95	360	25.3	947	833	9.1	104	16.18	1.78
BXRC-35S1001-B-73-SE	3500	95	270	33.7	1011	890	9.1	111	16.73	1.99
BXRC-35S1001-C-73-SE	3500	95	360	33.7	1349	1187	12.1	111	22.33	1.99
BXRC-35S1001-D-73-SE	3500	95	360	25.3	1052	926	9.1	116	17.82	1.96
BXRC-40S1001-B-73-SE	4000	95	270	33.7	1028	905	9.1	113	16.73	1.97
BXRC-40S1001-C-73-SE	4000	95	360	33.7	1371	1206	12.1	113	22.31	1.97
BXRC-40S1001-D-73-SE	4000	95	360	25.3	1098	967	9.1	121	18.13	1.99
BXRC-50S1001-B-74-SE	5000	95	270	33.7	1078	949	9.1	119	17.67	2.06
BXRC-50S1001-C-74-SE	5000	95	360	33.7	1438	1265	12.1	119	23.57	2.06
BXRC-50S1001-D-74-SE	5000	95	360	25.3	1147	1009	9.1	126	18.74	2.06
BXRC-57S1001-B-74-SE	5700	95	270	33.7	1103	971	9.1	121	18.14	2.1
BXRC-57S1001-C-74-SE	5700	95	360	33.7	1471	1295	12.1	121	24.19	2.1
BXRC-57S1001-D-74-SE	5700	95	360	25.3	1157	1018	9.1	127	18.79	2.06
BXRC-65S1001-B-74-SE	6500	95	270	33.7	1087	956	9.1	119	17.87	2.07
BXRC-65S1001-C-74-SE	6500	95	360	33.7	1449	1275	12.1	119	23.82	2.07
BXRC-65S1001-D-74-SE	6500	95	360	25.3	1127	992	9.1	124	18.86	2.07

Notes for Table 2:

- Product CCT is not targeted at $T_j = 85^\circ\text{C}$. Nominal CCT as defined by ANSI C78.377-2011.
- All CRI values are measured at $T_j = T_c = 25^\circ\text{C}$. CRI values are minimums. Bridgelux maintains a ± 3 tolerance on CRI values.
- Drive current is referred to as nominal drive current.
- Products tested under pulsed condition (10ms pulse width) at nominal test current where T_j (junction temperature) = T_c (case temperature) = 25°C . Typical stabilized DC performance values are provided as reference only and are not a guarantee of performance.
- Typical performance values are provided as a reference only and are not a guarantee of performance.
- Typical performance is estimated based on operation under DC (direct current) with LED array mounted onto a heat sink with thermal interface material and the case temperature maintained at 85°C . Based on Bridgelux test setup, values may vary depending on the thermal design of the luminaire and/or the exposed environment to which the product is subjected.
- Bridgelux maintains a $\pm 7\%$ tolerance on flux measurements.
- Minimum flux values at the nominal test current are guaranteed by 100% test.
- Minimum flux values at elevated temperatures are provided for reference only and are not guaranteed by 100% production testing. Based on Bridgelux test setup, values may vary depending on the thermal design of the luminaire and/or the exposed environment to which the product is subjected.

European Product Registry for Energy Labeling

The European Product Registry for Energy Labeling (EPREL) is defined in the EU Regulation 2017/1369 to provide important energy efficiency information to consumers. Together with Energy Labeling Regulation ELR (EU) 2019/2015 which was amended by regulation (EU) 2021/340 for energy labelling of light sources, manufacturers are required to declare an energy class based on key technical specifications from each of their product and register it in an open data base managed by EPREL. It is now a legal requirement for a vendor of light sources to upload information about their products into the EPREL database before placing these products on the market in the EU.

Table 3 below provides a list of part numbers that are in compliance with ELR and are currently listed in the EPREL database.

At Bridgelux, we are fully committed to supplying products that are compliant with pertinent laws, rules, and obligation imposed by relevant government bodies including the European Energy Labeling regulation. Customers can use these products with full confidence for any projects that fall under the ELR.

Table 3: Part numbers registered in European Product Registry for Energy Labeling

PART NUMBER ¹	CCT (K)	CRI	Current ² (mA)	Vf (V)	Useful flux ³ (Φ_{use}) at 85C (lm)	Power (W)	Efficacy (lm/W)	Energy efficiency class ⁴	Registration No	URL to Product Information Sheet in EPREL Database
BXRC-27S1001-C-72-SE	2700	97	620	34.4	1600	21.3	75	G	872673	https://eprelec.europa.eu/qr/872673
BXRC-27S1001-C-73-SE	2700	97	620	34.4	1600	21.3	75	G	872674	https://eprelec.europa.eu/qr/872674
BXRC-30S1001-C-73-SE	3000	97	720	35.1	1944	25.3	77	G	879038	https://eprelec.europa.eu/qr/879038

Notes for Table 3:

- All device listed here must be disposed as e-waste upon its end of life according to local country guideline in each country.
- For information on performance values at alternative drive conditions, please refer to the Product Selection Guide, Absolute Maximum Rating Table and Performance Curves in this data sheet.
- For a definition of useful luminous flux (Φ_{use}), please see the ELR regulations at <https://tinyurl.com/4b6zvt4m>.
- EPREL requires an arrow symbol containing the letter of the energy efficiency class to be displayed, on technical promotional material. Refer to this energy efficiency class column for specific energy efficiency class on each part number.

Performance at Commonly Used Drive Currents

Vero SE Thrive LED arrays are tested to the specifications shown using the nominal drive currents in Table 1. Vero SE Thrive LED Arrays may also be driven at other drive currents dependent on specific application design requirements. The performance at any drive current can be derived from the current vs. voltage characteristics shown in Figures 11, 12 & 13 and the flux vs. current characteristics shown in Figures 14, 15 & 16. The performance at commonly used drive currents is summarized in Table 4.

Table 4: Product Performance at Commonly Used Drive Currents

Part Number	CRI	Drive Current ¹ (mA)	Typical V _f T _c = 25°C (V)	Typical Power T _c = 25°C (W)	Typical Flux ² T _c = 25°C (lm)	Typical DC Flux ³ T _c = 85°C (lm)	Typical Efficacy T _c = 25°C (lm/W)
BXRC-27S1001-B-73-SE	95	135	33.2	4.4	535	480	121
		180	33.6	6.1	701	629	116
		270	34.4	9.3	1003	903	108
		405	35.6	14.3	1472	1309	103
		540	36.6	19.3	1885	1669	98
BXRC-27S1001-C-73-SE	95	180	33.2	5.9	711	635	120
		240	33.6	8.1	932	828	115
		360	34.4	12.4	1337	1204	108
		540	35.6	19.0	1948	1692	102
BXRC-27S1001-D-73-SE	95	240	36.6	25.7	2488	2130	97
		180	24.9	4.5	507	467	113
		240	25.2	6.0	667	613	110
		360	25.8	9.3	975	888	105
BXRC-27S1001-E-73-SE	95	540	26.7	14.4	1407	1262	98
		720	27.5	19.8	1818	1378	92
		135	33.2	4.4	574	516	130
		180	33.6	6.1	753	675	124
BXRC-30S1001-B-73-SE	95	270	34.4	9.3	1077	970	116
		405	35.6	14.3	1581	1406	111
		540	36.6	19.3	2025	1792	105
		180	33.2	5.9	764	682	129
BXRC-30S1001-C-73-SE	95	240	33.6	8.1	1001	889	124
		360	34.4	12.4	1437	1293	116
		540	35.6	19.0	2092	1817	110
		720	36.6	25.7	2672	2287	104
BXRC-30S1001-D-73-SE	95	180	24.9	4.5	541	498	121
		240	25.2	6.0	711	654	118
		360	25.8	9.3	1040	947	112
		540	26.7	14.4	1500	1347	104
BXRC-30S1001-E-73-SE	95	720	27.5	19.8	1939	1470	98
		135	33.2	4.4	599	538	135
		180	33.6	6.1	785	704	130
		270	34.4	9.3	1124	1011	121
BXRC-35S1001-B-73-SE	95	405	35.6	14.3	1649	1467	116
		540	36.6	19.3	2112	1870	109
		180	33.2	5.9	797	711	135
		240	33.6	8.1	1044	927	129
BXRC-35S1001-C-73-SE	95	360	34.4	12.4	1498	1349	121
		540	35.6	19.0	2182	1896	115
		720	36.6	25.7	2787	2386	108
		240	33.6	8.1	1044	927	129

Notes for Table 4:

1. Alternate drive currents are provided for reference only and are not a guarantee of performance.
2. Bridgelux maintains a ± 7% tolerance on flux measurements.
3. Typical stabilized DC performance values are provided as reference only and are not a guarantee of performance.

Performance at Commonly Used Drive Currents

Table 4: Product Performance at Commonly Used Drive Currents (Continued)

Part Number	CRI	Drive Current ¹ (mA)	Typical V _f T _c = 25°C (V)	Typical Power T _c = 25°C (W)	Typical Flux ² T _c = 25°C (lm)	Typical DC Flux ³ T _c = 85°C (lm)	Typical Efficacy T _c = 25°C (lm/W)
BXRC-35S1001-D-73-SE	95	180	24.9	4.5	601	554	134
		240	25.2	6.0	790	726	131
		360	25.8	9.3	1156	1052	124
		540	26.7	14.4	1667	1496	116
		720	27.5	19.8	2154	1633	109
BXRC-40S1001-B-73-SE	95	135	33.2	4.4	609	547	137
		180	33.6	6.1	798	716	132
		270	34.4	9.3	1142	1028	123
		405	35.6	14.3	1676	1491	117
		540	36.6	19.3	2147	1900	111
BXRC-40S1001-C-73-SE	95	180	33.2	5.9	810	723	137
		240	33.6	8.1	1061	943	132
		360	34.4	12.4	1523	1371	123
		540	35.6	19.0	2218	1927	117
		720	36.6	25.7	2833	2425	110
BXRC-40S1001-D-73-SE	95	180	24.9	4.5	627	578	140
		240	25.2	6.0	825	758	136
		360	25.8	9.3	1207	1098	130
		540	26.7	14.4	1741	1562	121
		720	27.5	19.8	2250	1705	114
BXRC-50S1001-B-74-SE	95	135	33.2	4.4	638	574	144
		180	33.6	6.1	837	751	138
		270	34.4	9.3	1198	1078	129
		405	35.6	14.3	1758	1564	123
		540	36.6	19.3	2252	1993	117
BXRC-50S1001-C-74-SE	95	180	33.2	5.9	849	758	144
		240	33.6	8.1	1113	989	138
		360	34.4	12.4	1598	1438	129
		540	35.6	19.0	2326	2021	122
		720	36.6	25.7	2972	2544	116
BXRC-50S1001-D-73-SE	95	180	24.9	4.5	655	604	146
		240	25.2	6.0	862	792	142
		360	25.8	9.3	1260	1147	136
		540	26.7	14.4	1818	1631	126
		720	27.5	19.8	2349	1781	119
BXRC-57S1001-B-74-SE	95	135	33.2	4.4	653	587	147
		180	33.6	6.1	857	768	142
		270	34.4	9.3	1226	1103	132
		405	35.6	14.3	1799	1600	126
		540	36.6	19.3	2304	2039	119

Notes for Table 4:

1. Alternate drive currents are provided for reference only and are not a guarantee of performance.
2. Bridgelux maintains a ± 7% tolerance on flux measurements.
3. Typical stabilized DC performance values are provided as reference only and are not a guarantee of performance.

Performance at Commonly Used Drive Currents

Table 4: Product Performance at Commonly Used Drive Currents (Continued)

Part Number	CRI	Drive Current ¹ (mA)	Typical V _f T _c = 25°C (V)	Typical Power T _c = 25°C (W)	Typical Flux ² T _c = 25°C (lm)	Typical DC Flux ³ T _c = 85°C (lm)	Typical Efficacy T _c = 25°C (lm/W)
BXRC-35S1001-D-73-SE	95	180	24.9	4.5	601	554	134
		240	25.2	6.0	790	726	131
		360	25.8	9.3	1156	1052	124
		540	26.7	14.4	1667	1496	116
		720	27.5	19.8	2154	1633	109
BXRC-40S1001-B-73-SE	95	135	33.2	4.4	609	547	137
		180	33.6	6.1	798	716	132
		270	34.4	9.3	1142	1028	123
		405	35.6	14.3	1676	1491	117
		540	36.6	19.3	2147	1900	111
BXRC-40S1001-C-73-SE	95	180	33.2	5.9	810	723	137
		240	33.6	8.1	1061	943	132
		360	34.4	12.4	1523	1371	123
		540	35.6	19.0	2218	1927	117
		720	36.6	25.7	2833	2425	110
BXRC-40S1001-D-73-SE	95	180	24.9	4.5	627	578	140
		240	25.2	6.0	825	758	136
		360	25.8	9.3	1207	1098	130
		540	26.7	14.4	1741	1562	121
		720	27.5	19.8	2250	1705	114
BXRC-50S1001-B-74-SE	95	135	33.2	4.4	638	574	144
		180	33.6	6.1	837	751	138
		270	34.4	9.3	1198	1078	129
		405	35.6	14.3	1758	1564	123
		540	36.6	19.3	2252	1993	117
BXRC-50S1001-C-74-SE	95	180	33.2	5.9	849	758	144
		240	33.6	8.1	1113	989	138
		360	34.4	12.4	1598	1438	129
		540	35.6	19.0	2326	2021	122
		720	36.6	25.7	2972	2544	116
BXRC-50S1001-D-73-SE	95	180	24.9	4.5	655	604	146
		240	25.2	6.0	862	792	142
		360	25.8	9.3	1260	1147	136
		540	26.7	14.4	1818	1631	126
		720	27.5	19.8	2349	1781	119
BXRC-57S1001-B-74-SE	95	135	33.2	4.4	653	587	147
		180	33.6	6.1	857	768	142
		270	34.4	9.3	1226	1103	132
		405	35.6	14.3	1799	1600	126
		540	36.6	19.3	2304	2039	119

Notes for Table 4:

1. Alternate drive currents are provided for reference only and are not a guarantee of performance.
2. Bridgelux maintains a ± 7% tolerance on flux measurements.
3. Typical stabilized DC performance values are provided as reference only and are not a guarantee of performance.

Spectrum Characteristics

Table 5: Typical Color Rendering Index and TM-30 Values at $T_c=85^\circ\text{C}$

Nominal CCT ¹	R _f	R _g	R ₁	R ₂	R ₃	R ₄	R ₅	R ₆	R ₇	R ₈	R ₉	R ₁₀	R ₁₁	R ₁₂	R ₁₃	R ₁₄	R ₁₅
2700K	95	103	97	99	94	94	97	98	97	98	99	97	91	98	98	95	98
3000K	95	104	98	99	93	94	97	98	96	96	97	96	92	95	98	95	97
3500K	95	98	98	98	97	98	98	98	98	97	93	97	97	95	98	97	98
4000K	97	100	99	99	97	99	99	99	99	98	94	97	99	96	99	98	98
5000K	97	100	98	99	98	98	98	98	99	98	95	98	98	98	98	98	97
5700K	94	98	98	98	97	95	98	97	96	95	92	97	96	96	98	98	97
6500K	95	98	98	98	97	96	98	98	96	96	93	97	96	97	98	98	97

Note for Table 5:

1. Bridgelux maintains a tolerance of ± 3 on Color Rendering Index R1-R15 measurements and TM-30 measurements.
2. The data shown in the table above is for reference only. Specific values from R1 to R15 will vary for each production run.

Figure 1: 2700K Thrive TM-30 Graphs

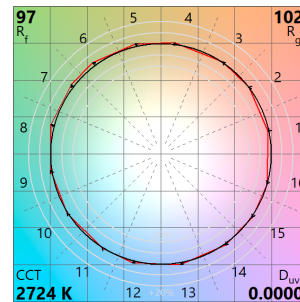
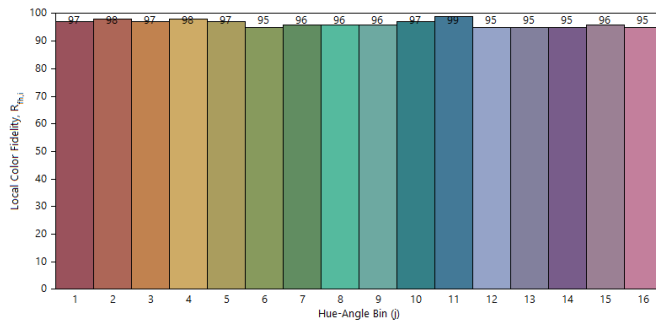

Figure 2: 3000K Thrive TM-30 Graphs

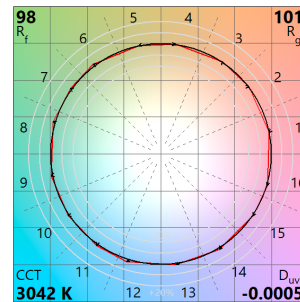
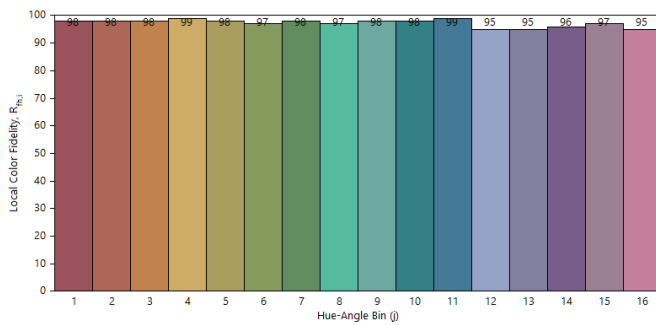
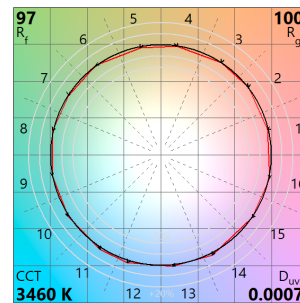
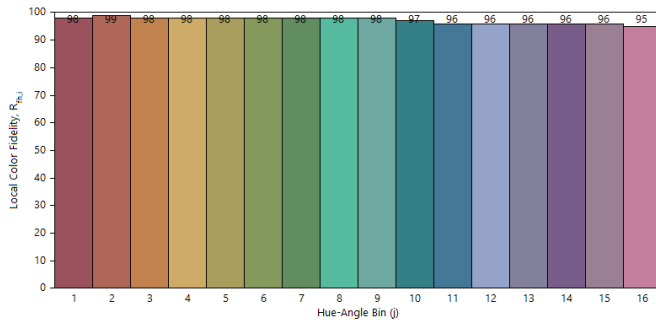

Figure 3: 3500K Thrive TM-30 Graphs



Spectrum Characteristics

Figure 4: 4000K Thrive TM-30 Graphs

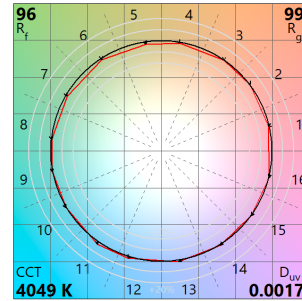
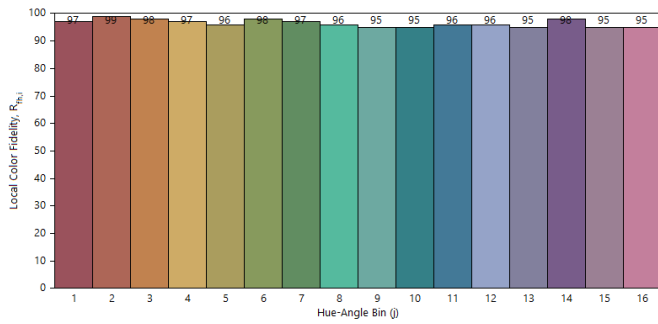

Figure 5: 5000K Thrive TM-30 Graphs

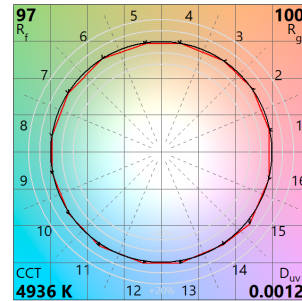
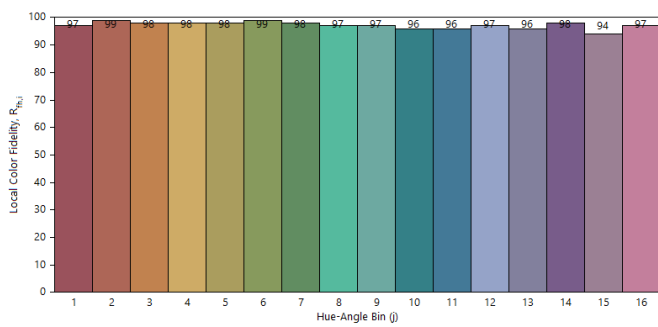

Figure 6: 5700K Thrive TM30 Graphs

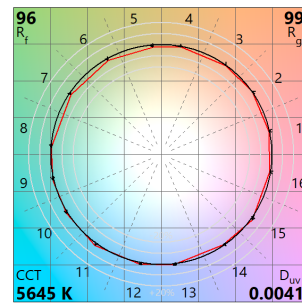
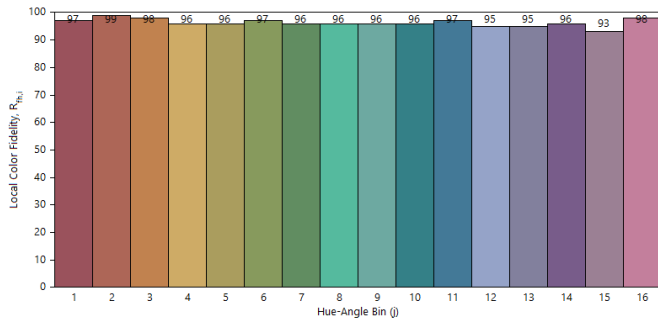
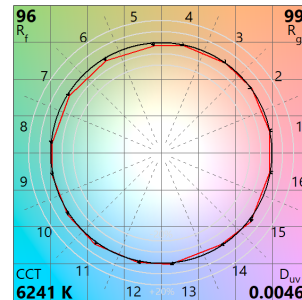
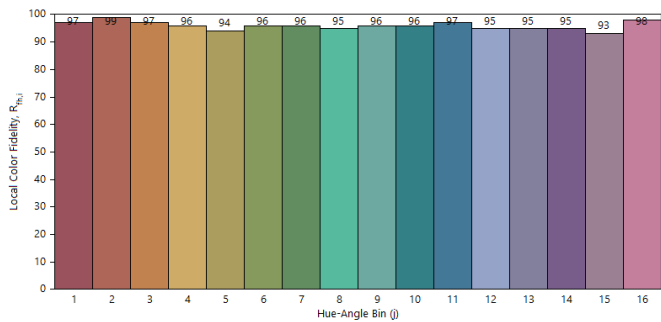
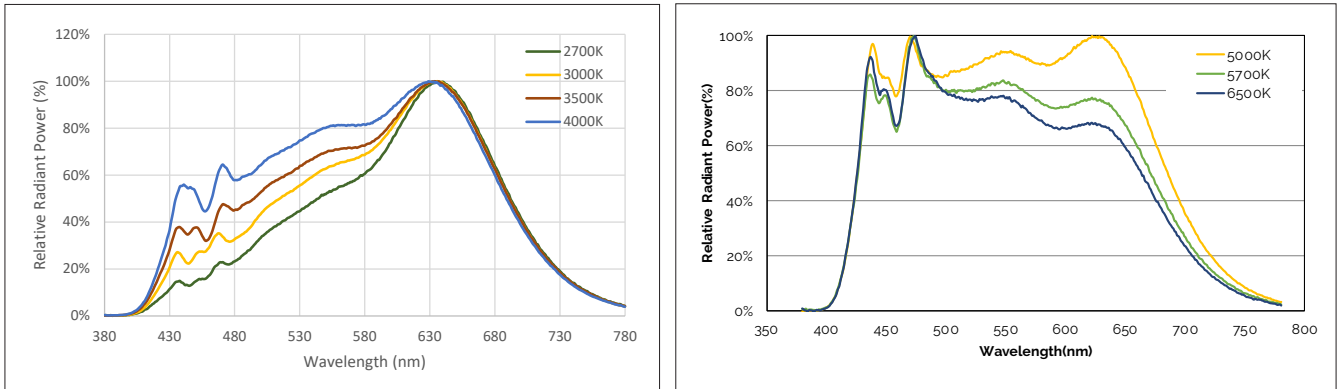

Figure 7: 6500K Thrive TM-30 Graphs



Spectrum Characteristics

Figure 8: Typical Color Spectrum



Note for Figure 8:

1. Color spectra measured at nominal current for $T_j = 85^\circ\text{C}$.

Table 6: Typical ASD Values at $T_c = 85^\circ\text{C}$.

Nominal CCT ¹	ASD
2700K	10%
3000K	9%
3500K	8%
4000K	8%
5000K	9%
5700K	9%
6500K	8%

Figure 9: SPD Comparison

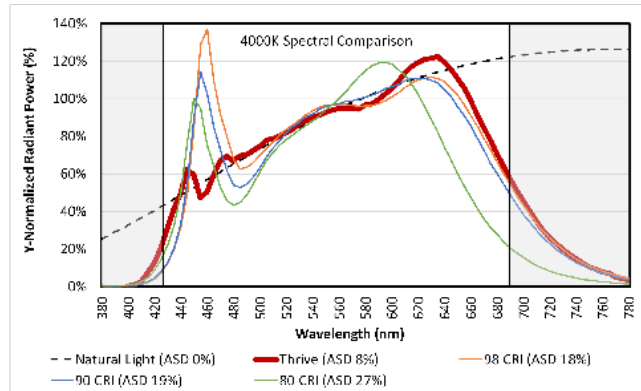

Spectral Matching to Natural Light

The lighting market is in the early stages of adoption of human-centric lighting (HCL). HCL encompasses the effects of lighting on the physical and emotional health and well-being of people. Throughout evolution, the human visual system has evolved under the natural light of sun and fire. These light sources have standardized industry spectral power definitions that describe the state of natural light. However, conventional metrics such as CCT, CRI, and TM-30 fail to adequately quantify the naturalness, or closeness of these light sources to the standardized natural spectra. Due to a lack of an industry standard metric to quantitatively measure the naturalness of a light source, Bridgelux has pioneered a new metric that takes the guesswork out of comparing LED light sources to natural light.

Average Spectral Difference, or ASD, is calculated by measuring the absolute difference between two spectra at discrete wavelengths. These values are averaged across a wavelength range derived from the photopic response curve, or $V(\lambda)$; a luminous efficiency function describing the average spectral sensitivity of human perception of brightness. The range of 425nm to 690nm was selected to remove the tails of the $V(\lambda)$ gaussian distribution below 1% of the peak value at 555nm, covering 99.9% of the area under the photopic response curve. Natural light is defined following the approach of IES TM-30; black body curves for light sources of $\leq 4000\text{K}$ and the CIE standard illuminant D for light sources of $\geq 5000\text{K}$.

Natural light has an ASD of 0%; lower ASD values indicate a closer match to natural light. Thrive is engineered to provide the closest match to natural light available using proprietary chip, phosphor and packaging technology, resulting in an ASD between 8% to 10% for all CCTs. By comparison, standard 80, 90, and 98 CRI light sources have ASD values that are 100% to 300% larger than Thrive. To learn more about the ASD metric, please contact your Bridgelux sales representative.

Electrical Characteristics

Table 7: Electrical Characteristics

Part Number	Drive Current (mA)	Forward Voltage Pulsed, $T_c = 25^\circ\text{C}$ (V) ^{1, 2, 3, 8}			Typical Coefficient of Forward Voltage ⁴ $\Delta V_f / \Delta T_c$ (mV/ $^\circ\text{C}$)	Typical Thermal Resistance Junction to Case ^{5,6} R_{j-c} ($^\circ\text{C}/\text{W}$)	Driver Selection Voltages ⁷ (V)	
		Minimum	Typical	Maximum			V_f Min. Hot $T_c = 105^\circ\text{C}$ (V)	V_f Max. Cold $T_c = -40^\circ\text{C}$ (V)
BXRC-xxx1001-B-7x-SE	270	32.2	34.4	37.4	-16.1	0.49	30.9	38.5
	540	34.2	36.6	39.8	-16.1	0.56	32.1	39.9
BXRC-xxx1001-C-7x-SE	360	32.2	34.4	37.4	-16.1	0.37	30.9	38.5
	720	34.2	36.6	39.8	-16.1	0.45	32.1	39.9
BXRC-xxx1001-D-7x-SE	360	24.2	25.8	28.1	-10.9	0.49	23.3	28.8
	720	25.7	27.5	29.9	-10.9	0.56	25.1	30.9

Notes for Table 7:

- Parts are tested in pulsed conditions, $T_c = 25^\circ\text{C}$. Pulse width is 10ms.
- Voltage minimum and maximum are provided for reference only and are not a guarantee of performance.
- Bridgelux maintains a tester tolerance of $\pm 0.10\text{V}$ on forward voltage measurements.
- Typical coefficient of forward voltage tolerance is $\pm 0.1\text{mV}$ for nominal current.
- Thermal resistance values are based from test data of a 3000K 80 CRI product.
- Thermal resistance value was calculated using total electrical input power; optical power was not subtracted from input power. The thermal interface material used during testing is not included in the thermal resistance value.
- V_f min hot and max cold values are provided as reference only and are not guaranteed by test. These values are provided to aid in driver design and selection over the operating range of the product.
- This product has been designed and manufactured per IEC 62031:2018. This product has passed dielectric withstand voltage testing at 1160 V. The working voltage designated for the insulation is 80V d.c. The maximum allowable voltage across the array must be determined in the end product application.

Absolute Maximum Ratings

Table 8: Maximum Ratings

Parameter	Maximum Rating		
LED Junction Temperature (T _j)	150°C		
Storage Temperature	-40°C to +105°C		
Operating Case Temperature ¹ (T _c)	105°C		
Soldering Temperature ²	300°C or lower for a maximum of 6 seconds		
	BXRC-xxx1001-B-7x-SE	BXRC-xxx1001-C-7x-SE	BXRC-xxx1001-D-7x-SE
Maximum Drive Current ³	540mA	720mA	720mA
Maximum Peak Pulsed Drive Current ⁴	770mA	1030mA	1030mA
Maximum Reverse Voltage ⁵	-60V	-60V	-45V

Notes for Table 8:

1. For IEC 62717 requirement, please consult your Bridgelux sales representative.
2. Refer to Bridgelux Application Note AN31: Handling and Assembly of Vero, Vero SE and Vesta SE LED Modules.
3. Arrays may be driven at higher currents however lumen maintenance may be reduced.
4. Bridgelux recommends a maximum duty cycle of 10% and pulse width of 20 ms when operating LED Arrays at maximum peak pulsed current specified. Maximum peak pulsed currents indicate values where LED Arrays can be driven without catastrophic failures.
5. Light emitting diodes are not designed to be driven in reverse voltage and will not produce light under this condition. Maximum rating provided for reference only.

Eye Safety

Table 9: Eye Safety Risk Group (RG) Classifications

Part Number	Drive Current ⁵ (mA)	CCT ^{2,5}			
		2700K/3000K	4000K ²	5000K ³	6500K ⁴
BXRC-xxx100x-B-7x-SE	270	RG1	RG1	RG1	RG1
	405	RG1	RG1	RG1	RG2
	540	RG1	RG1	RG2	RG2
BXRC-xxx100x-C-7x-SE	360	RG1	RG1	RG1	RG2
	540	RG1	RG1	RG2	RG2
	720	RG1	RG2	RG2	RG2
BXRC-xxx100x-D-7x-SE	360	RG1	RG1	RG1	RG2
	540	RG1	RG1	RG2	RG2
	720	RG1	RG1	RG2	RG2

Notes for Table 9:

1. Eye safety classification for the use of Bridgelux Vero SE Series LED arrays is in accordance with specification IEC/TR 62778: Application of IEC 62471 for the assessment of blue light hazard to light sources and luminaires.
2. For products classified as RG2 at 4000K, $E_{thr} = 1847.5$ lx.
3. For products classified as RG2 at 5000K, $E_{thr} = 1315.8$ lx.
4. For products classified as RG2 at 6500K, $E_{thr} = 1124.5$ lx.

Product Bin Definitions

Table 10: 2-, 3- and 4-step MacAdam Ellipse Color Bin Definitions

CCT	Center Point		Degree	2-step		3-step		4-step	
	x	y	(°)	a	b	a	b	a	b
2700K	0.4567	0.4109	53.700	0.00540	0.00280	0.0081	0.0042	N/A	N/A
3000K	0.4324	0.4048	53.217	0.00556	0.00272	0.0083	0.0041	N/A	N/A
4000K	0.3828	0.3819	53.717	0.00626	0.00268	0.0094	0.0040	N/A	N/A
5000K	0.3457	0.3581	59.617	N/A	N/A	0.0082	0.0035	0.0110	0.0047
5700K	0.3298	0.3445	59.060	N/A	N/A	0.0074	0.0032	0.0099	0.0042
6500K	0.3150	0.3328	58.567	N/A	N/A	0.0066	0.0028	0.0090	0.0038

Notes for Table 10:

1. Color binning at $T_c = 85^\circ\text{C}$
2. Bridgelux maintains a tolerance of ± 0.007 on x and y color coordinates in the CIE 1931 color space.

Figure 10: C.I.E. 1931 Chromaticity Diagram (Color targeted at $T_c = 85^\circ\text{C}$)

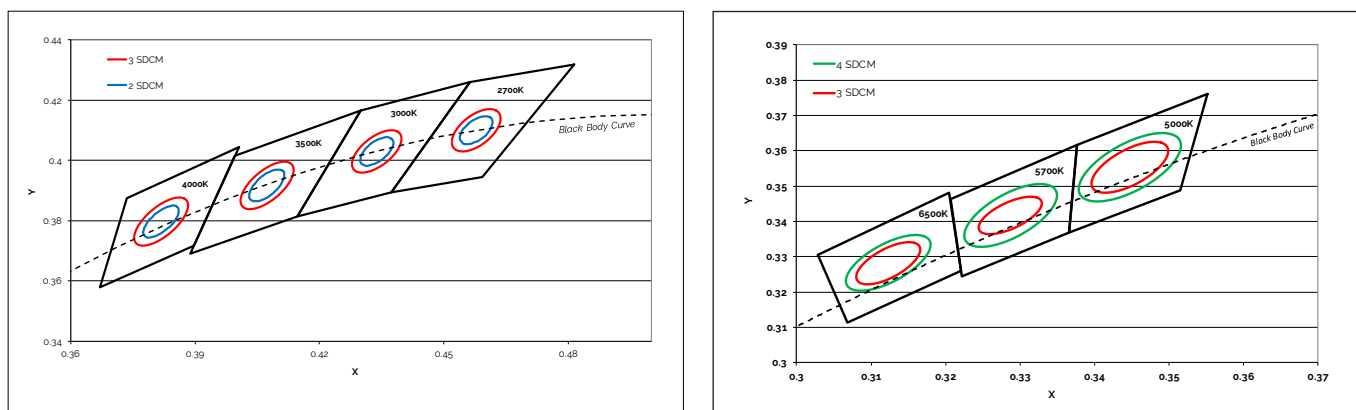

Performance Curves

Figure 11: Vero SE 10B Drive Current vs. Voltage ($T_c=25^\circ\text{C}$)

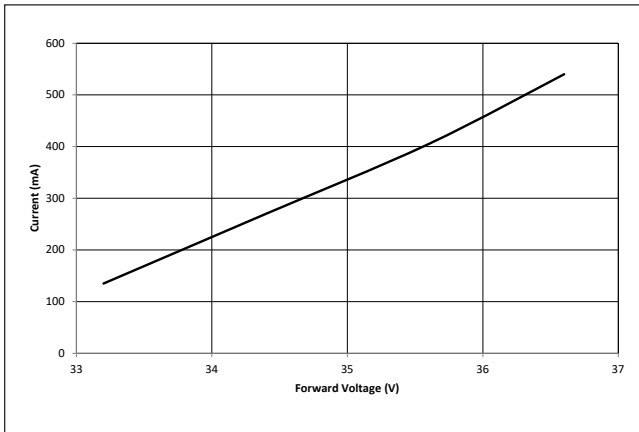

Figure 12: Vero SE 10C Drive Current vs. Voltage ($T_c=25^\circ\text{C}$)

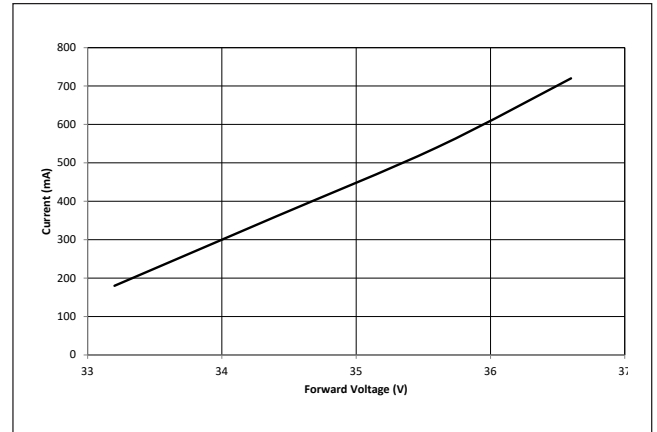

Figure 13: Vero SE 10D Drive Current vs. Voltage ($T_c=25^\circ\text{C}$)

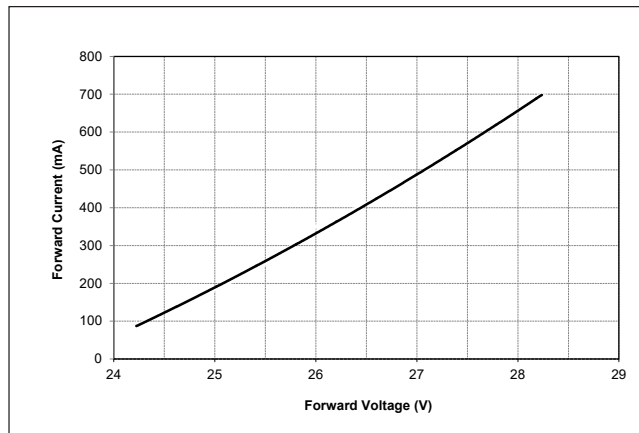

Figure 14: Vero SE 10B Typical Relative Flux vs. Current ($T_c=25^\circ\text{C}$)

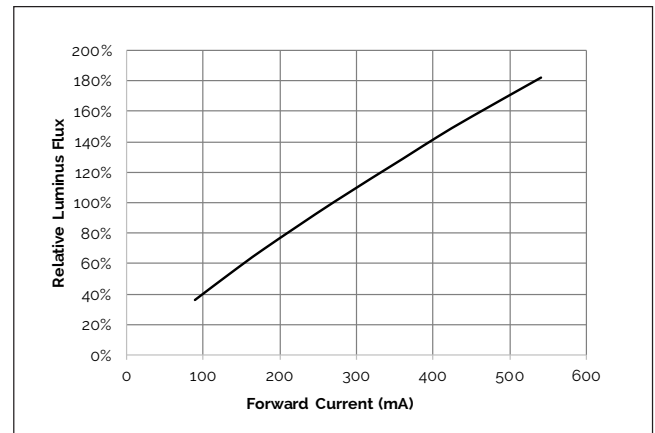

Figure 15: Vero SE 10C Typical Relative Flux vs. Current ($T_c=25^\circ\text{C}$)

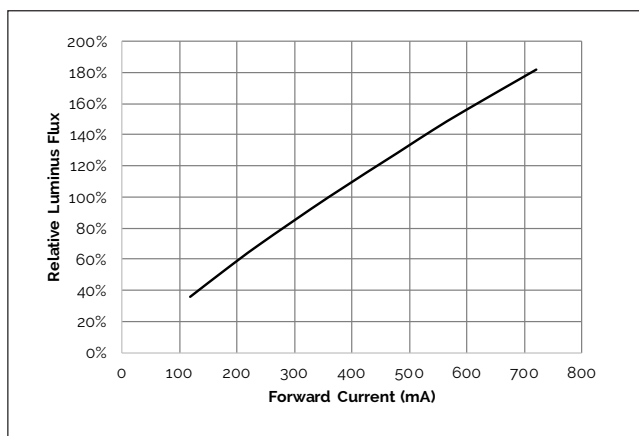
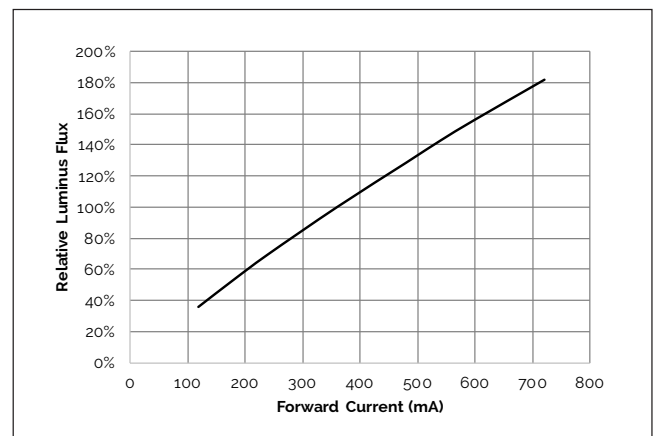

Figure 16: Vero SE 10D Typical Relative Flux vs. Current ($T_c=25^\circ\text{C}$)



Performance Curves

Figure 17: Typical DC Flux vs. Case Temperature

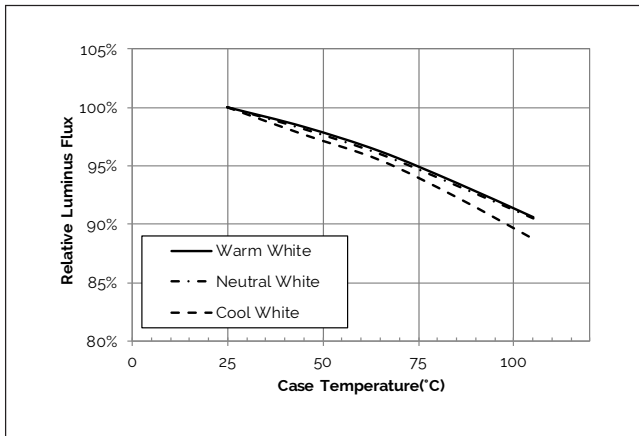

Figure 18: Typical ccx Shift vs. Case Temperature

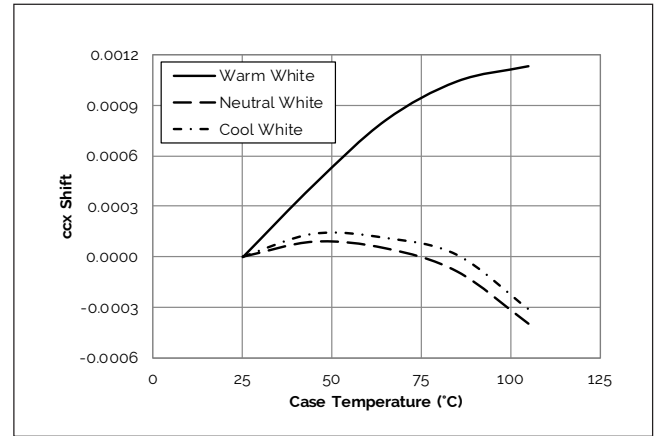
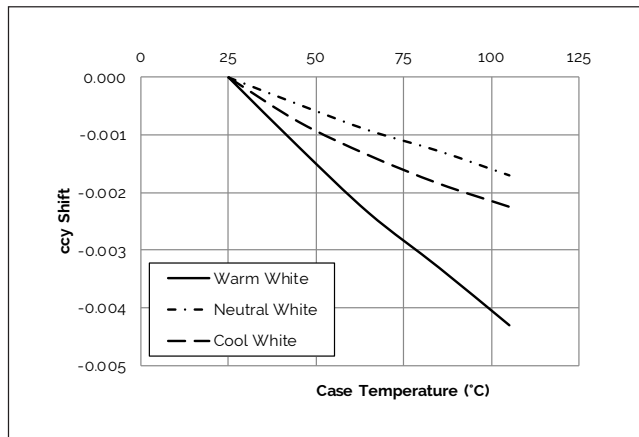

Figure 19: Typical ccy Shift vs. Case Temperature



Notes for Figures 17-19:

1. Bridgelux does not recommend driving high power LEDs at low currents. Doing so may produce unpredictable results. Pulse width modulation (PWM) is recommended for dimming effects.
2. Characteristics shown for warm white based on 3000K Thrive
3. Characteristics shown for neutral white based on 4000K Thrive
4. Characteristics shown for cool white based on 5000K Thrive
5. For other color SKUs, the shift in color will vary. Please contact your Bridgelux Sales Representative for more information.

Typical Radiation Pattern

Figure 20: Typical Spatial Radiation Pattern

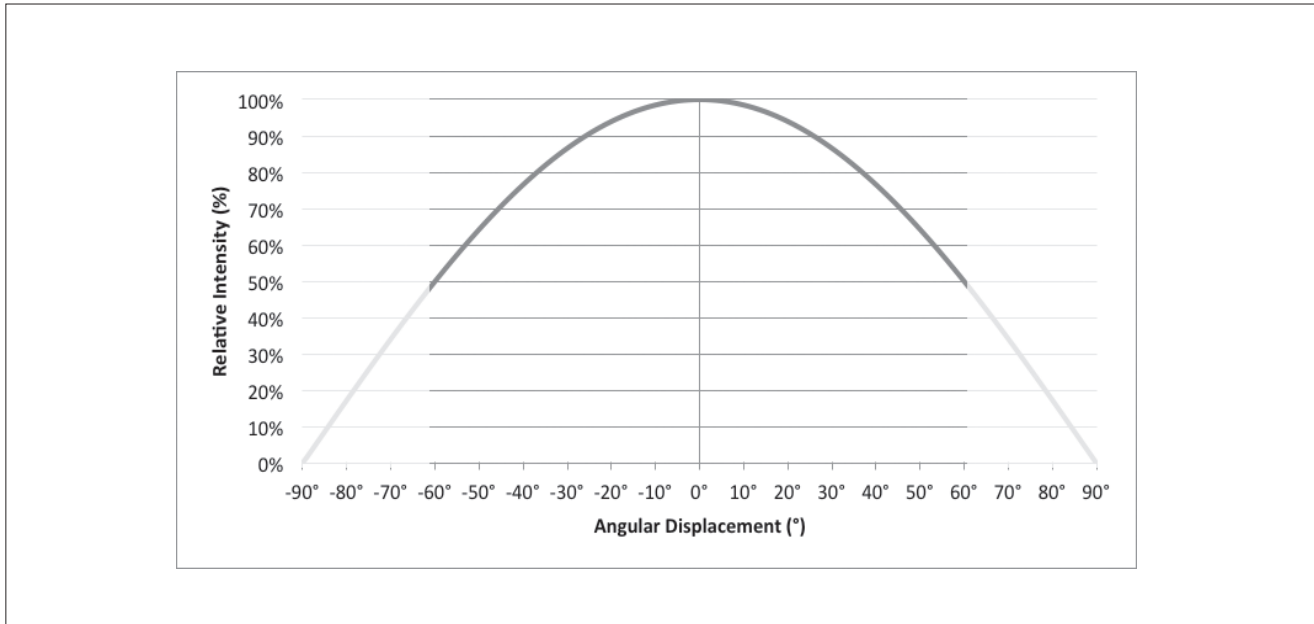

Notes for Figure 20:

- 1. Typical viewing angle is 120°.
- 2. The viewing angle is defined as the off axis angle from the centerline where intensity is 1/2 of the peak value.

Figure 21: Typical Polar Radiation Pattern

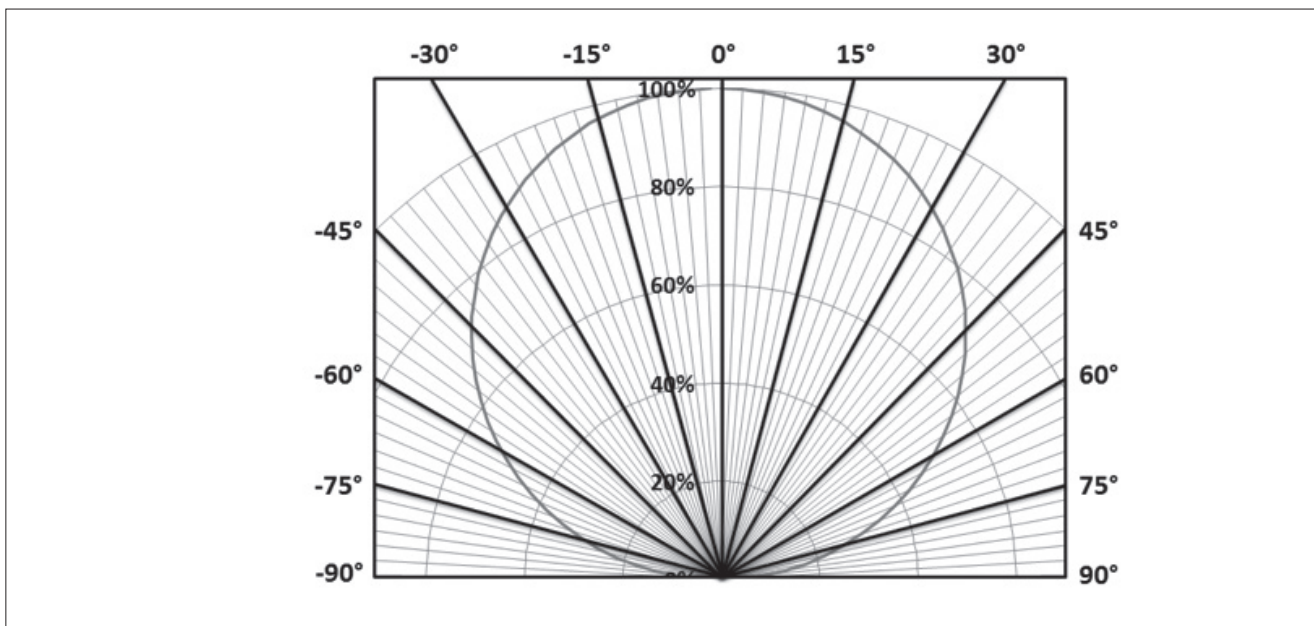

Mechanical Dimensions

Figure 22: Drawing for Vero SE 10 LED Array

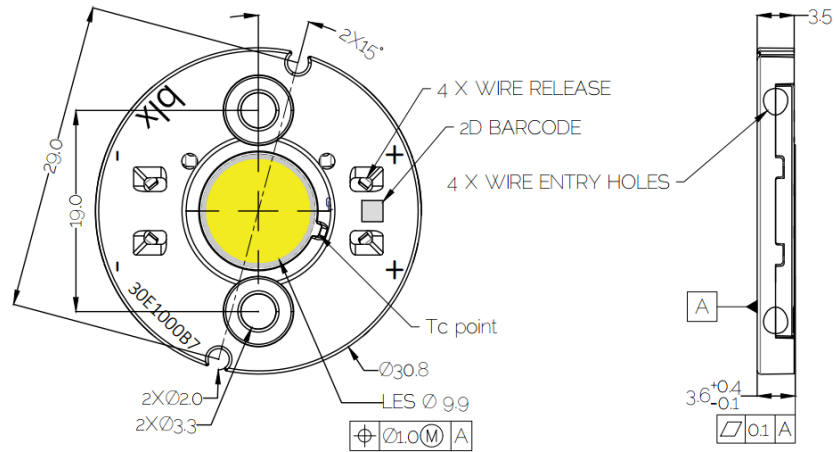

Notes for Figure 22:

1. Drawings are not to scale.
2. Dimensions are in mm.
3. Unless otherwise specified, tolerances are $\pm 0.10\text{mm}$.
4. Mounting holes (2X) are for M3 screws.
5. Bridgelux recommends two tapped holes for mounting screws with $19.0 \pm 0.10\text{mm}$ center-to-center spacing.
6. Screws with flat shoulders (pan, dome, button, round, truss, mushroom) provide optimal torque control. Do NOT use flat, countersink, or raised head screws.
7. The optical center of the LED Array is nominally defined by the mechanical center of the array to a tolerance of $\pm 0.2\text{mm}$.
8. Bridgelux maintains a flatness of 0.10mm across the mounting surface of the array.

Packaging and Labeling

Figure 23: Vero SE 10 Packaging

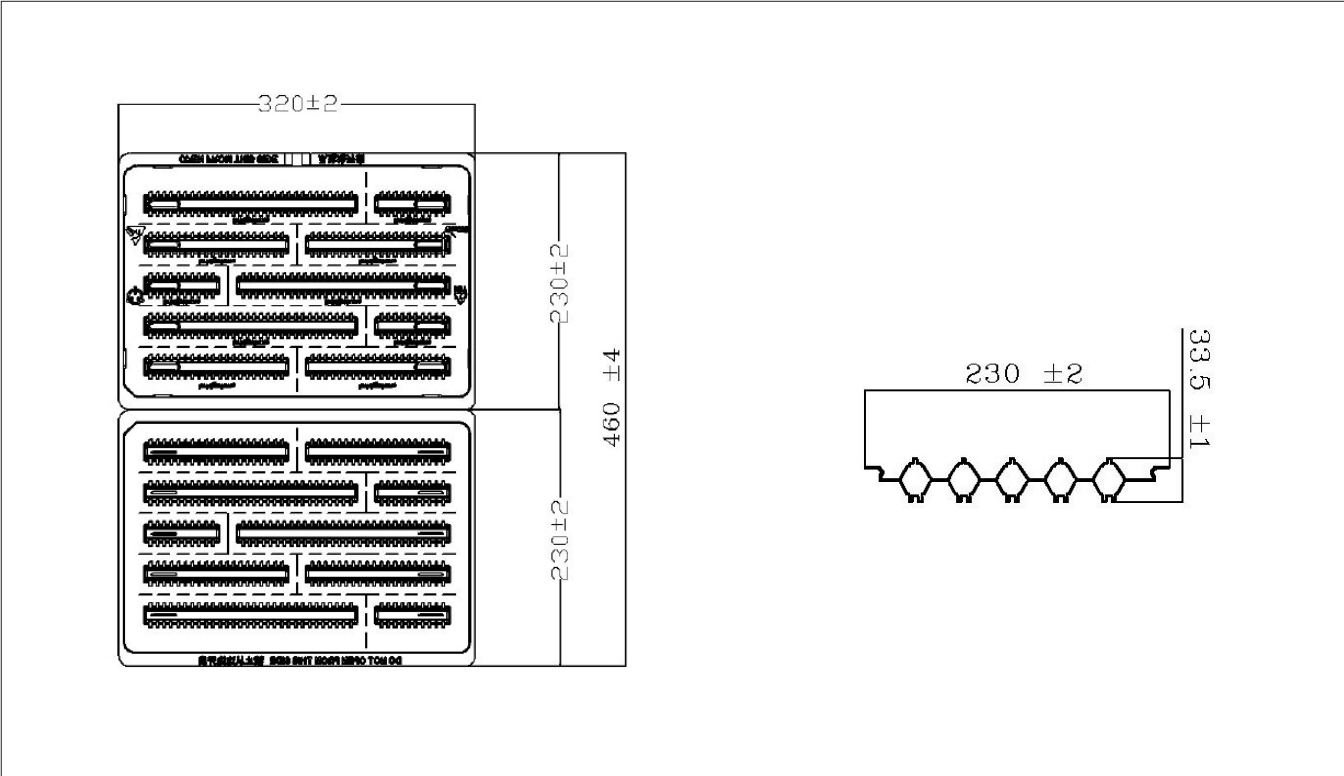

- Notes for Figure 23:
- 1. Dimensions are in millimeters.
 - 2. Drawings are not to scale.

Packaging and Labeling

Figure 24: Vero SE Series Packaging and Labeling

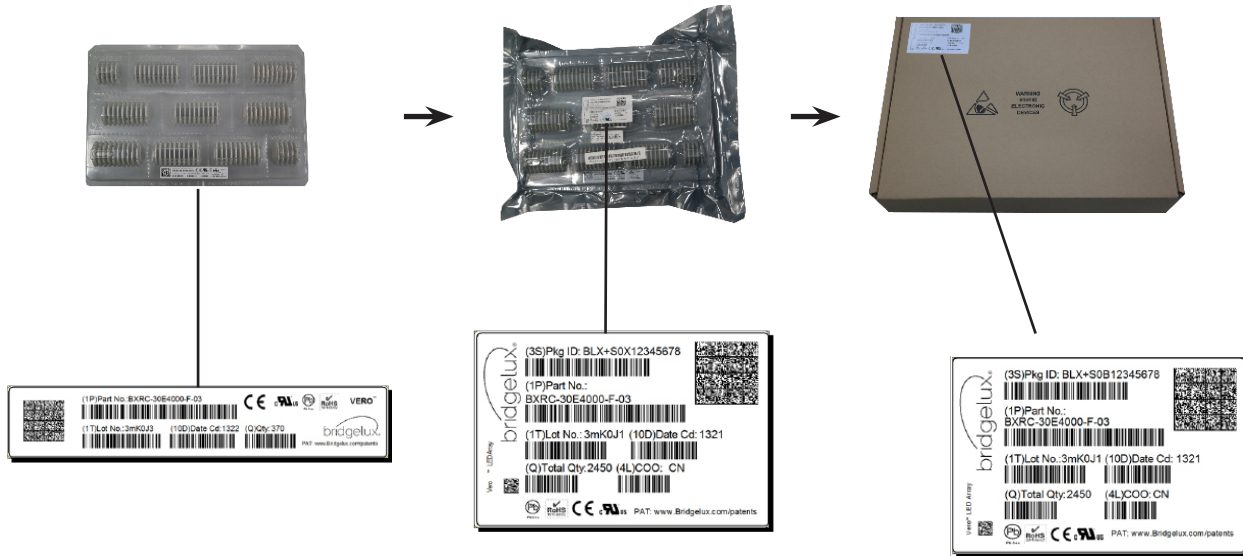

Notes for Figure 24:

1. Each tray holds 200 COBs.
2. Each tray is vacuum sealed in an anti-static bag and placed in its own box.
3. Each tray, bag and box is to be labeled as shown above.

Figure 25: Gen. 7 Product Labeling

Bridgelux COB arrays have laser markings on the back side of the substrate to help with product identification. In addition to the product identification markings, Bridgelux COB arrays also contain markings for internal Bridgelux manufacturing use only. The image below shows which markings are for customer use and which ones are for Bridgelux internal use only. The Bridgelux internal manufacturing markings are subject to change without notice, however these will not impact the form, function or performance of the COB array.

Customer Use- 2D Barcode
Scannable barcode provides product part number and other Bridgelux internal production information.

Customer Use- Product part number — **30E1000C 73 2F** — **Customer Use- V_i Bin Code**
included to enable greater luminaire design flexibility. Refer to ANG2 for bin code definitions.

Design Resources

Application Notes

Bridgelux has developed a comprehensive set of application notes and design resources to assist customers in successfully designing with the Vero SE product family of LED array products. For all available application notes visit www.bridgelux.com.

Optical Source Models

Optical source models and ray set files are available for all Bridgelux products. For a list of available formats, visit www.bridgelux.com.

3D CAD Models

Three dimensional CAD models depicting the product outline of all Bridgelux Vero SE LED arrays are available in both IGS and STEP formats. Please contact your Bridgelux sales representative for assistance.

LM80

LM80 testing has been completed and the LM80 report is now available. Please contact your Bridgelux sales representative for LM-80 report.

Precautions

CAUTION: CHEMICAL EXPOSURE HAZARD

Exposure to some chemicals commonly used in luminaire manufacturing and assembly can cause damage to the LED array. Please consult Bridgelux Application Note AN120 for additional information.

CAUTION: RISK OF BURN

Do not touch the Vero SE LED array during operation. Allow the array to cool for a sufficient period of time before handling. The Vero SE LED array may reach elevated temperatures such that could burn skin when touched.

CAUTION

CONTACT WITH LIGHT EMITTING SURFACE (LES)

Avoid any contact with the LES. Do not touch the LES of the LED array or apply stress to the LES (yellow phosphor resin area). Contact may cause damage to the LED array.

Optics and reflectors must not be mounted in contact with the LES (yellow phosphor resin area). Optical devices may be mounted on the top surface of the plastic housing of the Vero LED array. Use the mechanical features of the LED array housing, edges and/or mounting holes to locate and secure optical devices as needed.

Disclaimers

MINOR PRODUCT CHANGE POLICY

The rigorous qualification testing on products offered by Bridgelux provides performance assurance. Slight cosmetic changes that do not affect form, fit, or function may occur as Bridgelux continues product optimization.

STANDARD TEST CONDITIONS

Unless otherwise stated, array testing is performed at the nominal drive current.

About Bridgelux: Bridging Light and Life™

At Bridgelux, we help companies, industries and people experience the power and possibility of light. Since 2002, we've designed LED solutions that are high performing, energy efficient, cost effective and easy to integrate. Our focus is on light's impact on human behavior, delivering products that create better environments, experiences and returns—both experiential and financial. And our patented technology drives new platforms for commercial and industrial luminaires.

For more information about the company, please visit
bridgelux.com
twitter.com/Bridgelux
facebook.com/Bridgelux
linkedin.com/company/bridgelux-inc-_2
youtube.com/user/Bridgelux
WeChat ID: BridgeluxInChina



46410 Fremont Boulevard
Fremont, CA 94538 USA
Tel (925) 583-8400
www.bridgelux.com