



Bridgelux® V13 F90 Array Series

Product Data Sheet DS447



Introduction

V Series



The V Series™ LED Array products deliver high quality light in a compact and cost-effective solid-state lighting package. These chip on board (CoB) arrays can be efficiently driven up to two times the nominal drive current, enabling design flexibility not previously possible. These high flux density light sources are designed to support a wide range of high quality, low cost directional luminaires and replacement lamps for both interior and exterior commercial and residential applications.

The F90 V Series COB is a high efficacy product that uses narrow band red phosphor to significantly improve the spectrum efficacy. The improved spectrum efficacy results in the 90 CRI product of the F90 Series delivering better or equivalent efficacy as that of our traditional 80 CRI V Series product.

The V13 LED Array is available in a variety of electrical, CCT, and CRI combinations providing substantial design flexibility and energy efficiency advantages.

Lighting system designs incorporating these LED arrays deliver increased system level efficacy and a longer service life. Typical applications include replacement lamps and task, accent, spot, track, wide area, security, wall packs and down lights.

Features

- Efficacy of 188 lm/W typical, 3000K 90 CRI
- Wide selection of CCT options (2700K-5000K) with minimum 90 CRI options
- Uniform high-quality illumination
- 2 and 3 SDCM binning options (2700K – 4000K)
- 3 and 4 SDCM binning options (5000K)
- Forward voltage bin codes and backside marking
- Instant light with unlimited dimming
- 5-Year warranty

Benefits

- Enables high efficiency lighting systems and lower operating costs
- Supports the trend toward luminaire miniaturization and delivers enhanced optical control
- Design flexibility for a broad range of lighting applications
- Clean white light without pixelation
- Uniform consistent white light
- Design flexibility for multi-source applications
- Easy to use with daylight and motion sensors to increase energy savings
- Design with confidence



Contents

| | |
|---|----|
| Product Feature Map | 2 |
| Product Nomenclature | 2 |
| Product Selection Guide | 3 |
| European Product Registry for Energy Labeling | 5 |
| Performance at Commonly Used Drive Currents | 6 |
| Electrical Characteristics | 8 |
| Eye Safety | 9 |
| Absolute Maximum Ratings | 10 |
| Performance Curves | 11 |
| Typical Radiation Pattern | 13 |
| Typical Color Spectrum | 14 |
| Mechanical Dimensions | 15 |
| Color Binning Information | 16 |
| Packaging and Labeling | 17 |
| Design Resources | 19 |
| Precautions | 19 |
| Disclaimers | 19 |
| About Bridgelux | 20 |

Product Feature Map

Bridgelux arrays are fully engineered devices that provide consistent thermal and optical performance on an engineered mechanical platform. The V Series arrays are the most compact chip-on-board devices across all of Bridgelux's LED Array products.

The arrays incorporate several features to simplify design integration and assembly. Please visit www.bridgelux.com for more information on the V Series family of products.

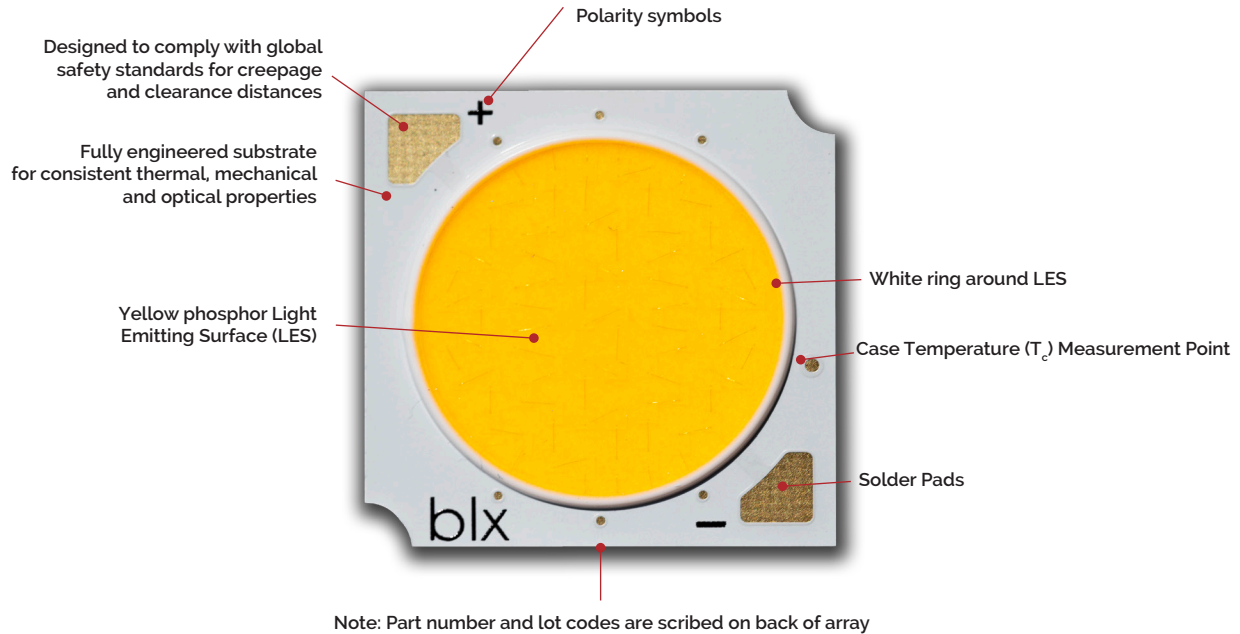

Product Nomenclature

The part number designation for Bridgelux V Series LED arrays is explained as follows:

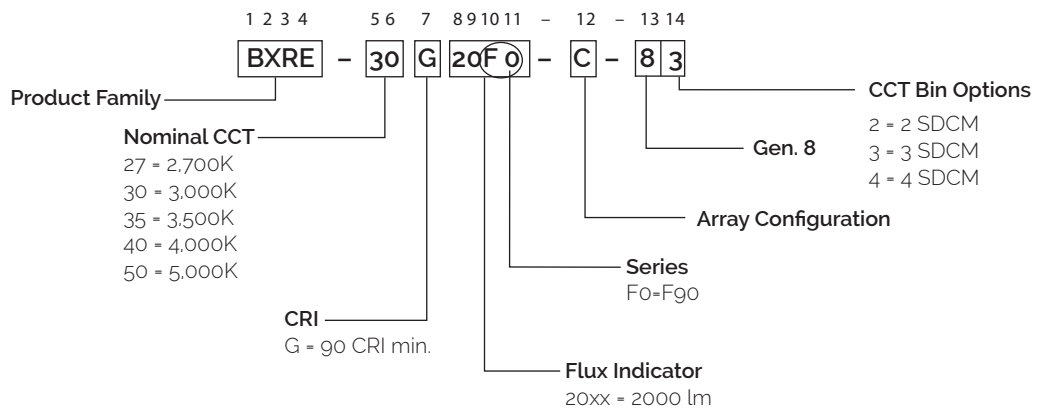

Product Selection Guide

The following product configurations are available:

Table 1: Selection Guide, Pulsed Measurement Data ($T_j = T_c = 25^\circ\text{C}$)

| Part Number | Nominal CCT ¹ (K) | CRI ² | Nominal Drive Current ³ (mA) | Typical Pulsed Flux ^{4,5,6} $T_c = 25^\circ\text{C}$ (lm) | Minimum Pulsed Flux ^{6,7} $T_c = 25^\circ\text{C}$ (lm) | Typical V_f (V) | Typical Power (W) | Typical Efficacy (lm/W) |
|-------------------|------------------------------|------------------|---|--|--|-------------------|-------------------|-------------------------|
| BXRE-27G20F0-B-8x | 2700 | 90 | 350 | 2211 | 1989 | 34.3 | 12.0 | 184 |
| BXRE-27G20F0-C-8x | 2700 | 90 | 500 | 3146 | 2832 | 34.3 | 17.1 | 184 |
| BXRE-30G20F0-B-8x | 3000 | 90 | 350 | 2256 | 2030 | 34.3 | 12.0 | 188 |
| BXRE-30G20F0-C-8x | 3000 | 90 | 500 | 3210 | 2889 | 34.3 | 17.1 | 187 |
| BXRE-35G20F0-B-8x | 3500 | 90 | 350 | 2278 | 2050 | 34.3 | 12.0 | 190 |
| BXRE-35G20F0-C-8x | 3500 | 90 | 500 | 3242 | 2918 | 34.3 | 17.1 | 189 |
| BXRE-40G20F0-B-8x | 4000 | 90 | 350 | 2301 | 2071 | 34.3 | 12.0 | 192 |
| BXRE-40G20F0-C-8x | 4000 | 90 | 500 | 3275 | 2947 | 34.3 | 17.1 | 191 |
| BXRE-50G20F0-B-8x | 5000 | 90 | 350 | 2233 | 2010 | 34.3 | 12.0 | 186 |
| BXRE-50G20F0-C-8x | 5000 | 90 | 500 | 3178 | 2860 | 34.3 | 17.1 | 185 |

Notes for Table 1:

- Nominal CCT as defined by ANSI C78.377-2011.
- CRI values are minimums and tested at $T_j = T_c = 85^\circ\text{C}$. Minimum Rg value for 90 CRI products is 50. Bridgelux maintains a ± 3 tolerance on CRI and Rg values.
- Drive current is referred to as nominal drive current.
- Products tested under pulsed condition (10ms pulse width) at nominal test current where T_j (junction temperature) - T_c (case temperature) = 25°C .
- Typical performance values are provided as a reference only and are not a guarantee of performance.
- Bridgelux maintains a $\pm 7\%$ tolerance on flux measurements.
- Minimum flux values at the nominal test current are guaranteed by 100% test.

Product Selection Guide

Table 2: Selection Guide, Stabilized DC Performance ($T_c = 85^\circ\text{C}$)^{4,5}

| Part Number | Nominal CCT ¹ (K) | CRI ² | Nominal Drive Current ³ (mA) | Typical DC Flux ^{4,5} $T_c = 85^\circ\text{C}$ (lm) | Minimum DC Flux ⁶ $T_c = 85^\circ\text{C}$ (lm) | Typical V_f (V) | Typical Power (W) | Typical Efficacy (lm/W) |
|-------------------|---------------------------------|------------------|---|---|---|----------------------|-------------------------|-------------------------------|
| BXRE-27G20F0-B-8x | 2700 | 90 | 350 | 2034 | 1830 | 33.4 | 11.7 | 174 |
| BXRE-27G20F0-C-8x | 2700 | 90 | 500 | 2894 | 2605 | 33.4 | 16.7 | 173 |
| BXRE-30G20F0-B-8x | 3000 | 90 | 350 | 2075 | 1868 | 33.4 | 11.7 | 177 |
| BXRE-30G20F0-C-8x | 3000 | 90 | 500 | 2954 | 2658 | 33.4 | 16.7 | 177 |
| BXRE-35G20F0-B-8x | 3500 | 90 | 350 | 2096 | 1886 | 33.4 | 11.7 | 179 |
| BXRE-35G20F0-C-8x | 3500 | 90 | 500 | 2983 | 2685 | 33.4 | 16.7 | 178 |
| BXRE-40G20F0-B-8x | 4000 | 90 | 350 | 2117 | 1905 | 33.4 | 11.7 | 181 |
| BXRE-40G20F0-C-8x | 4000 | 90 | 500 | 3013 | 2711 | 33.4 | 16.7 | 180 |
| BXRE-50G20F0-B-8x | 5000 | 90 | 350 | 2054 | 1849 | 33.4 | 11.7 | 175 |
| BXRE-50G20F0-C-8x | 5000 | 90 | 500 | 2924 | 2632 | 33.4 | 16.7 | 175 |

Notes for Table 2:

1. Nominal CCT as defined by ANSI C78.377-2011.
2. CRI values are minimums and tested at $T_j = T_c = 85^\circ\text{C}$. Minimum R_g value for 90 CRI products is 50.
3. Drive current is referred to as nominal drive current.
4. Typical stabilized DC performance values are provided as reference only and are not a guarantee of performance.
5. Typical performance is estimated based on operation under DC (direct current) with LED array mounted onto a heat sink with thermal interface material and the case temperature maintained at 85°C . Based on Bridgelux test setup, values may vary depending on the thermal design of the luminaire and/or the exposed environment to which the product is subjected.
6. Minimum flux values at elevated temperatures are provided for reference only and are not guaranteed by 100% production testing. Based on Bridgelux test setup, values may vary depending on the thermal design of the luminaire and/or the exposed environment to which the product is subjected.

European Product Registry for Energy Labeling

The European Product Registry for Energy Labeling (EPREL) is defined in the EU Regulation 2017/1369 to provide important energy efficiency information to consumers. Together with Energy Labeling Regulation ELR (EU) 2019/2015 which was amended by regulation (EU) 2021/340 for energy labelling of light sources, manufacturers are required to declare an energy class based on key technical specifications from each of their product and register it in an open data base managed by EPREL. It is now a legal requirement for a vendor of light sources to upload information about their products into the EPREL database before placing these products on the market in the EU.

Table 3 below provides a list of part numbers that are in compliance with ELR and are currently listed in the EPREL database.

At Bridgelux, we are fully committed to supplying products that are compliant with pertinent laws, rules, and obligation imposed by relevant government bodies including the European Energy Labeling regulation. Customers can use these products with full confidence for any projects that fall under the ELR.

Table 3: Part numbers registered in European Product Registry for Energy Labeling

| PART NUMBER ¹ | CCT (K) | CRI | Current ² (mA) | Vf (V) | Useful flux ³ (Φ_{use}) at 85C (lm) | Power (W) | Efficacy (lm/W) | Energy efficiency class ⁴ | Registration No | URL to Product Information Sheet in EPREL Database |
|--------------------------|---------|-----|---------------------------|--------|---|-----------|-----------------|--------------------------------------|-----------------|---|
| BXRE-27G20F0-B-83 | 2700 | 90 | 900 | 38.6 | 4597 | 34.8 | 132 | E | 1115626 | https://eprelec.europa.eu/qr/1115626 |
| BXRE-27G20F0-C-83 | 2700 | 90 | 1260 | 38.0 | 6422 | 47.9 | 134 | E | 1115627 | https://eprelec.europa.eu/qr/1115627 |
| BXRE-30G20F0-B-83 | 3000 | 90 | 900 | 38.6 | 4691 | 34.8 | 135 | E | 878976 | https://eprelec.europa.eu/qr/878976 |
| BXRE-30G20F0-C-83 | 3000 | 90 | 1260 | 38.0 | 6553 | 47.9 | 137 | E | 1024000 | https://eprelec.europa.eu/qr/1024000 |
| BXRE-35G20F0-B-83 | 3500 | 90 | 900 | 38.6 | 4738 | 34.8 | 136 | E | 1115633 | https://eprelec.europa.eu/qr/1115633 |
| BXRE-35G20F0-C-83 | 3500 | 90 | 1260 | 38.0 | 6619 | 47.9 | 138 | E | 1115634 | https://eprelec.europa.eu/qr/1115634 |
| BXRE-40G20F0-B-83 | 4000 | 90 | 900 | 38.6 | 4785 | 34.8 | 138 | E | 1024002 | https://eprelec.europa.eu/qr/1024002 |
| BXRE-40G20F0-C-83 | 4000 | 90 | 1260 | 38.0 | 6684 | 47.9 | 140 | E | 1115635 | https://eprelec.europa.eu/qr/1115635 |
| BXRE-50G20F0-B-84 | 5000 | 90 | 900 | 38.6 | 4644 | 34.8 | 134 | E | 1168480 | https://eprelec.europa.eu/qr/1168480 |
| BXRE-50G20F0-C-84 | 5000 | 90 | 1260 | 38.0 | 6488 | 47.9 | 136 | E | 1168481 | https://eprelec.europa.eu/qr/1168481 |
| | | | | | | | | | | |
| | | | | | | | | | | |

Notes for Table 3:

- All device listed here must be disposed as e-waste upon its end of life according to local country guideline in each country.
- For information on performance values at alternative drive conditions, please refer to the Product Selection Guide, Absolute Maximum Rating Table and Performance Curves in this data sheet.
- For a definition of useful luminous flux (Φ_{use}), please see the ELR regulations at <https://tinyurl.com/4b6zvt4m>.
- EPREL requires an arrow symbol containing the letter of the energy efficiency class to be displayed, on technical promotional material. Refer to this energy efficiency class column for specific energy efficiency class on each part number.

Performance at Commonly Used Drive Currents

V Series LED arrays are tested to the specifications shown using the nominal drive currents in Table 1. V Series may also be driven at other drive currents dependent on specific application design requirements. The performance at any drive current can be derived from the current vs. voltage characteristics shown in Figures 1 & 2 and the flux vs. current characteristics shown in Figures 3 & 4. The performance at commonly used drive currents is summarized in Table 4.

Table 4: Product Performance at Commonly Used Drive Currents

| Part Number | CRI | Drive Current ¹ (mA) | Typical V _f T _c = 25°C (V) | Typical Power T _c = 25°C (W) | Typical Flux ² T _c = 25°C (lm) | Typical DC Flux ³ T _c = 85°C (lm) | Typical Efficacy T _c = 25°C (lm/W) |
|-------------------|-----|---------------------------------|---|--|---|--|--|
| BXRE-27G20F0-B-8x | 90 | 175 | 33.0 | 5.8 | 1111 | 1040 | 192 |
| | | 260 | 33.6 | 8.7 | 1652 | 1534 | 189 |
| | | 350 | 34.3 | 12.0 | 2211 | 2034 | 184 |
| | | 450 | 35.0 | 15.7 | 2812 | 2561 | 179 |
| | | 700 | 36.6 | 25.6 | 4233 | 3757 | 165 |
| | | 900 | 37.7 | 34.0 | 5283 | 4591 | 156 |
| BXRE-27G20F0-C-8x | 90 | 250 | 33.0 | 8.2 | 1600 | 1498 | 194 |
| | | 375 | 33.6 | 12.6 | 2401 | 2228 | 190 |
| | | 500 | 34.3 | 17.1 | 3146 | 2894 | 184 |
| | | 630 | 34.9 | 22.0 | 3968 | 3617 | 180 |
| | | 1000 | 36.6 | 36.6 | 6081 | 5398 | 166 |
| | | 1260 | 37.7 | 47.5 | 7454 | 6490 | 157 |
| BXRE-30G20F0-B-8x | 90 | 175 | 33.0 | 5.8 | 1134 | 1061 | 196 |
| | | 260 | 33.6 | 8.7 | 1686 | 1565 | 193 |
| | | 350 | 34.3 | 12.0 | 2256 | 2075 | 188 |
| | | 450 | 35.0 | 15.7 | 2870 | 2614 | 182 |
| | | 700 | 36.6 | 25.6 | 4320 | 3834 | 169 |
| | | 900 | 37.7 | 34.0 | 5391 | 4685 | 159 |
| BXRE-30G20F0-C-8x | 90 | 250 | 33.0 | 8.2 | 1633 | 1528 | 198 |
| | | 375 | 33.6 | 12.6 | 2450 | 2274 | 194 |
| | | 500 | 34.3 | 17.1 | 3210 | 2954 | 187 |
| | | 630 | 34.9 | 22.0 | 4049 | 3691 | 184 |
| | | 1000 | 36.6 | 36.6 | 6206 | 5508 | 170 |
| | | 1260 | 37.7 | 47.5 | 7606 | 6622 | 160 |
| BXRE-35G20F0-B-8x | 90 | 175 | 33.0 | 5.8 | 1145 | 1072 | 198 |
| | | 260 | 33.6 | 8.7 | 1703 | 1581 | 195 |
| | | 350 | 34.3 | 12.0 | 2278 | 2096 | 190 |
| | | 450 | 35.0 | 15.7 | 2898 | 2640 | 184 |
| | | 700 | 36.6 | 25.6 | 4363 | 3872 | 170 |
| | | 900 | 37.7 | 34.0 | 5445 | 4732 | 160 |
| BXRE-35G20F0-C-8x | 90 | 250 | 33.0 | 8.2 | 1649 | 1543 | 200 |
| | | 375 | 33.6 | 12.6 | 2474 | 2296 | 196 |
| | | 500 | 34.3 | 17.1 | 3242 | 2983 | 189 |
| | | 630 | 34.9 | 22.0 | 4089 | 3728 | 186 |
| | | 1000 | 36.6 | 36.6 | 6268 | 5563 | 171 |
| | | 1260 | 37.7 | 47.5 | 7682 | 6688 | 162 |

Notes for Table 4:

1. Alternate drive currents in Table 4 are provided for reference only and are not a guarantee of performance.
2. Bridgelux maintains a ± 7% tolerance on flux measurements.
3. Typical stabilized DC performance values are provided as reference only and are not a guarantee of performance.

Performance at Commonly Used Drive Currents

Table 4: Product Performance at Commonly Used Drive Currents (Continued)

| Part Number | CRI | Drive Current ¹ (mA) | Typical V _f T _c = 25°C (V) | Typical Power T _c = 25°C (W) | Typical Flux ² T _c = 25°C (lm) | Typical DC Flux ³ T _c = 85°C (lm) | Typical Efficacy T _c = 25°C (lm/W) |
|-------------------|-----|------------------------------------|--|---|--|---|---|
| BXRE-40G20F0-B-8x | 90 | 175 | 33.0 | 5.8 | 1156 | 1082 | 200 |
| | | 260 | 33.6 | 8.7 | 1720 | 1596 | 197 |
| | | 350 | 34.3 | 12.0 | 2301 | 2117 | 192 |
| | | 450 | 35.0 | 15.7 | 2927 | 2666 | 186 |
| | | 700 | 36.6 | 25.6 | 4406 | 3911 | 172 |
| | | 900 | 37.7 | 34.0 | 5499 | 4779 | 162 |
| BXRE-40G20F0-C-8x | 90 | 250 | 33.0 | 8.2 | 1665 | 1559 | 202 |
| | | 375 | 33.6 | 12.6 | 2499 | 2319 | 198 |
| | | 500 | 34.3 | 17.1 | 3275 | 3013 | 191 |
| | | 630 | 34.9 | 22.0 | 4130 | 3765 | 188 |
| | | 1000 | 36.6 | 36.6 | 6330 | 5618 | 173 |
| | | 1260 | 37.7 | 47.5 | 7758 | 6755 | 163 |
| BXRE-50G20F0-B-8x | 90 | 175 | 33.0 | 5.8 | 1122 | 1051 | 194 |
| | | 260 | 33.6 | 8.7 | 1669 | 1550 | 191 |
| | | 350 | 34.3 | 12.0 | 2233 | 2054 | 186 |
| | | 450 | 35.0 | 15.7 | 2841 | 2588 | 181 |
| | | 700 | 36.6 | 25.6 | 4276 | 3796 | 167 |
| | | 900 | 37.7 | 34.0 | 5337 | 4638 | 157 |
| BXRE-50G20F0-C-8x | 90 | 250 | 33.0 | 8.2 | 1616 | 1513 | 196 |
| | | 375 | 33.6 | 12.6 | 2425 | 2251 | 192 |
| | | 500 | 34.3 | 17.1 | 3178 | 2924 | 185 |
| | | 630 | 34.9 | 22.0 | 4008 | 3654 | 182 |
| | | 1000 | 36.6 | 36.6 | 6144 | 5453 | 168 |
| | | 1260 | 37.7 | 47.5 | 7530 | 6556 | 159 |

Notes for Table 4:

1. Alternate drive currents in Table 4 are provided for reference only and are not a guarantee of performance.
2. Bridgelux maintains a ± 7% tolerance on flux measurements.
3. Typical stabilized DC performance values are provided as reference only and are not a guarantee of performance.

Electrical Characteristics

Table 5: Electrical Characteristics

| Part Number | Drive Current (mA) | Forward Voltage Pulsed, $T_c = 25^\circ\text{C}$ (V) ^{1, 2, 3, 8} | | | Typical Coefficient of Forward Voltage ⁴ $\Delta V_f / \Delta T_c$ (mV/ $^\circ\text{C}$) | Typical Thermal Resistance Junction to Case ^{5,6} R_{j-c} ($^\circ\text{C}/\text{W}$) | Driver Selection Voltages ⁷ (V) | |
|-------------------|--------------------|--|---------|---------|--|---|--|--|
| | | Minimum | Typical | Maximum | | | V_f Min. Hot $T_c = 95^\circ\text{C}$ (V) | V_f Max. Cold $T_c = -40^\circ\text{C}$ (V) |
| BXRE-xxx20F0-B-8x | 350 | 32.2 | 34.3 | 36.3 | -11 | 0.22 | 31.4 | 37.1 |
| | 900 | 35.5 | 37.7 | 40.0 | -12 | 0.34 | 34.6 | 40.8 |
| BXRE-xxx20F0-C-8x | 500 | 32.2 | 34.3 | 36.3 | -11 | 0.19 | 31.4 | 37.1 |
| | 1260 | 35.4 | 37.7 | 39.9 | -12 | 0.29 | 34.6 | 40.7 |

Notes for Table 5:

- Parts are tested in pulsed conditions, $T_c = 25^\circ\text{C}$. Pulse width is 10ms.
- Voltage minimum and maximum are provided for reference only and are not a guarantee of performance.
- Bridgelux maintains a tester tolerance of $\pm 0.10\text{V}$ on forward voltage measurements.
- Typical coefficient of forward voltage tolerance is $\pm 0.1\text{mV}$ for nominal current.
- Thermal resistance values are based from test data of a 3000K 90 CRI product.
- Thermal resistance value was calculated using total electrical input power; optical power was not subtracted from input power. The thermal interface material used during testing is not included in the thermal resistance value.
- V_f min hot and max cold values are provided as reference only and are not guaranteed by test. These values are provided to aid in driver design and selection over the operating range of the product.
- This product has been designed and manufactured per IEC 62031:2018. This product has passed dielectric withstand voltage testing at 1140 V. The working voltage designated for the insulation is 70V d.c. The maximum allowable voltage across the array must be determined in the end product application.

Eye Safety

Table 6: Eye Safety Risk Group (RG) Classifications

| Part Number | Drive Current (mA) | CCT ⁴ | |
|-------------------|--------------------|------------------|---------------------------|
| | | 2700K/3000K | 3500-5000K ^{2,3} |
| BXRE-xxx20Fx-B-8x | 870 | RG1 | RG1 |
| | 900 | RG1 | RG2 |
| BXRE-xxx20Fx-C-8x | 895 | RG1 | RG1 |
| | 1260 | RG1 | RG2 |

Notes for Table 6:

1. Eye safety classification for the use of Bridgelux V Series LED arrays is in accordance with specification IEC/TR 62778: Application of IEC 62471 for the assessment of blue light hazard to light sources and luminaires.
2. For products classified as RG2 at 4000K, Ethr= 1980 lx.
3. For products classified as RG2 at 5000K Ethr= 1530 lx.
4. Please contact your Bridgelux sales representative for Ethr values at specific drive currents and CCTs not listed.

Absolute Maximum Ratings

Table 7: Maximum Ratings

| Parameter | Maximum Rating | |
|---|---|--|
| LED Junction Temperature (T_j) | 150°C | |
| Storage Temperature ¹ | -40°C to +95°C | |
| Operating Case Temperature ² (T_c) | 95°C | |
| Soldering Temperature ³ | 300°C or lower for a maximum of 6 seconds | |
| | BXRE-xxx20F0-B-8x | BXRE-xxx20F0-C-8x |
| Maximum Drive Current ⁴ | 900 mA at $\leq 85^\circ\text{C}$ 675 mA at 95°C | 1260 mA at $\leq 85^\circ\text{C}$ 945 mA at 95°C |
| Maximum Peak Pulsed Drive Current ⁵ | 1290 mA | 1800 mA |
| Maximum Reverse Voltage ⁶ | -60V | -60V |

Notes for Table 7:

1. The Fg0 product is robust enough to pass our internal humidity test but it is still more sensitive compared to regular LED array product. The product needs to be stored in a dry environment. It is not recommended to use the product in a damp environment that directly exposes it to moisture.
2. For IEC 62717 requirement, please consult your Bridgelux sales representative.
3. Refer to Bridgelux Application Note AN101: Handling and Assembly of Bridgelux V Series LED Arrays
4. Arrays may be driven at higher currents however lumen maintenance may be reduced and warranty will not apply.
5. Bridgelux recommends a maximum duty cycle of 10% and pulse width of 20 ms when operating LED Arrays at maximum peak pulsed current specified. Maximum peak pulsed currents indicate values where LED Arrays can be driven without catastrophic failures.
6. Light emitting diodes are not designed to be driven in reverse voltage and will not produce light under this condition. Maximum rating provided for reference only.

Performance Curves

Figure 1: V13B Drive Current vs. Voltage

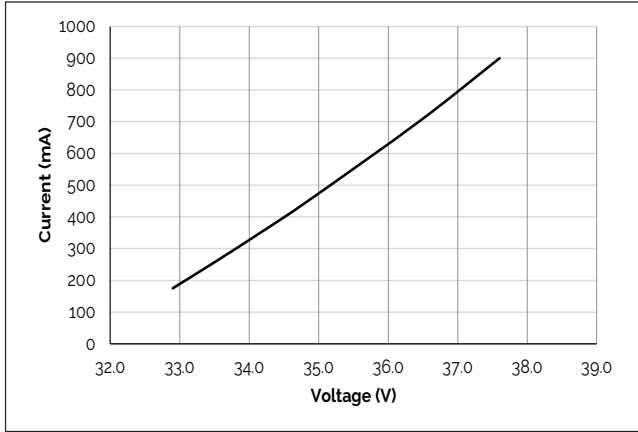

Figure 2: V13C Drive Current vs. Voltage

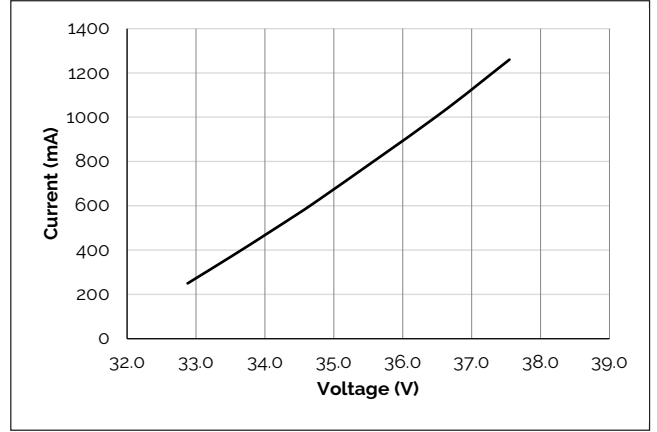

Figure 3: V13B Typical Relative Flux vs. Current

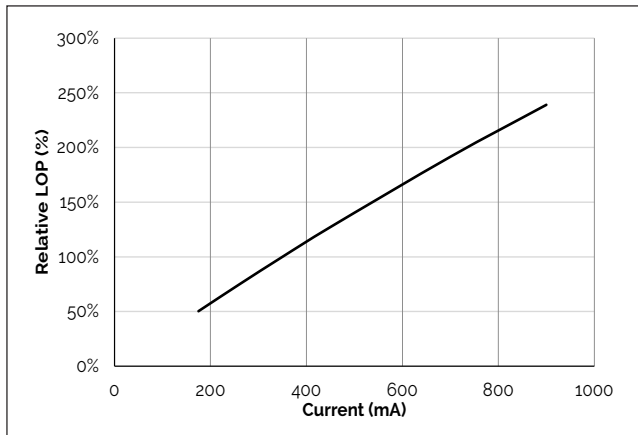

Figure 4: V13C Typical Relative Flux vs. Current

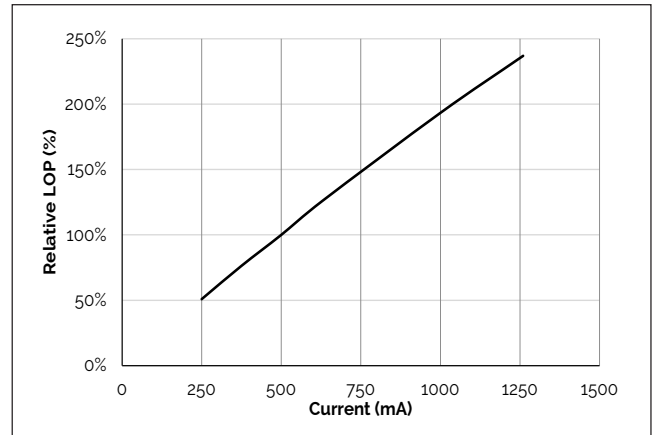

Figure 5: Typical DC Flux vs. Case Temperature

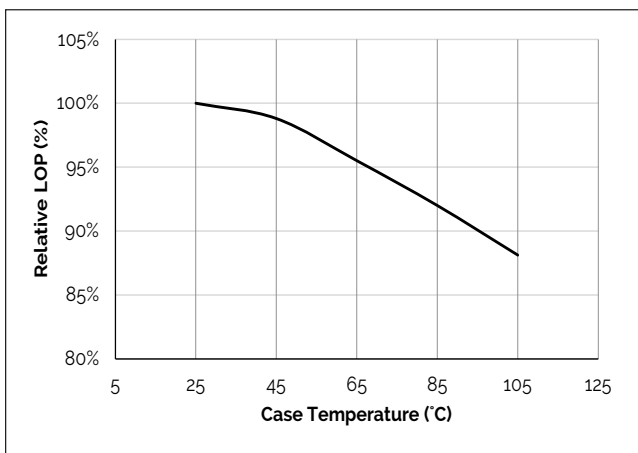
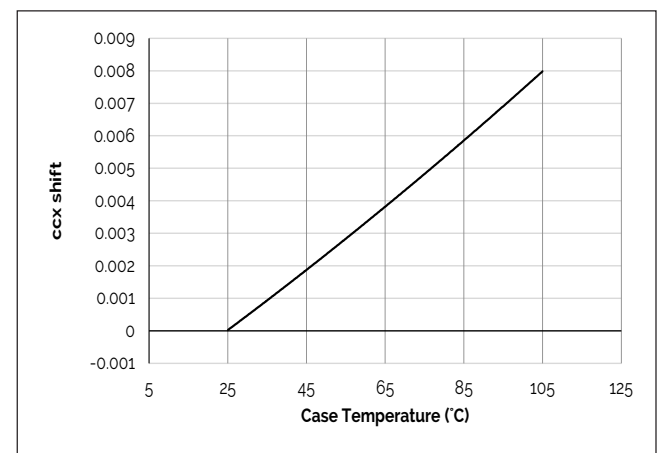

Figure 6: Typical DC ccx Shift vs. Case Temperature



Notes for Figures 1-4:

1. Bridgelux does not recommend driving high power LEDs at low currents. Doing so may produce unpredictable results. Pulse width modulation (PWM) is recommended for dimming effects.
2. Products tested under pulsed condition (10ms pulse width) at nominal test current where T_j (junction temperature) = T_c (case temperature) = 25°C.

Note for Figures 5-6:

1. Characteristics shown for Warm White.

Performance Curves

Figure 7: Typical DC ccy Shift vs. Case Temperature

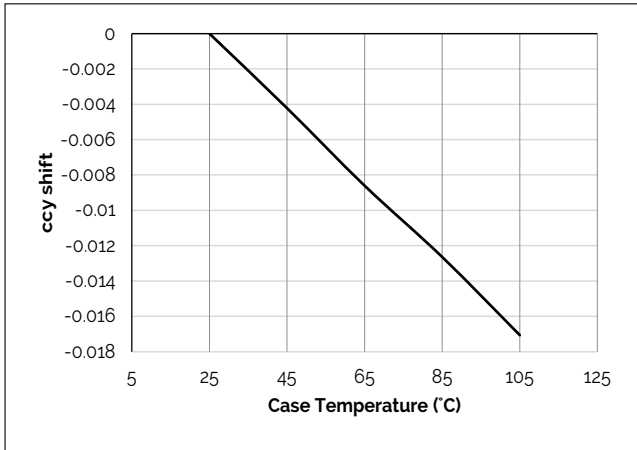

Figure 8: V13B Drive Current vs. ccx Shift

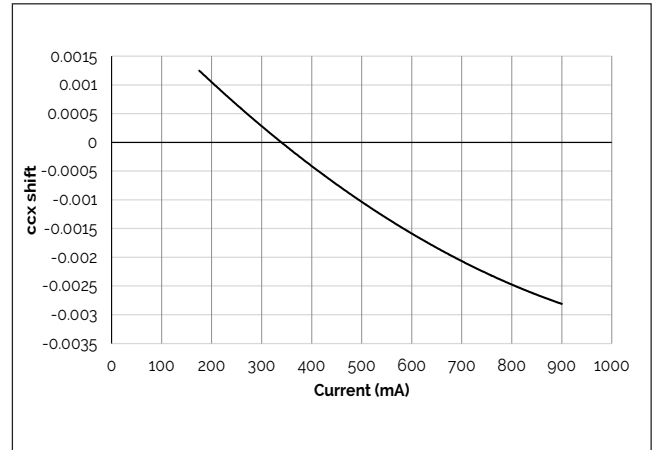

Figure 9: V13B Drive Current vs. ccy Shift

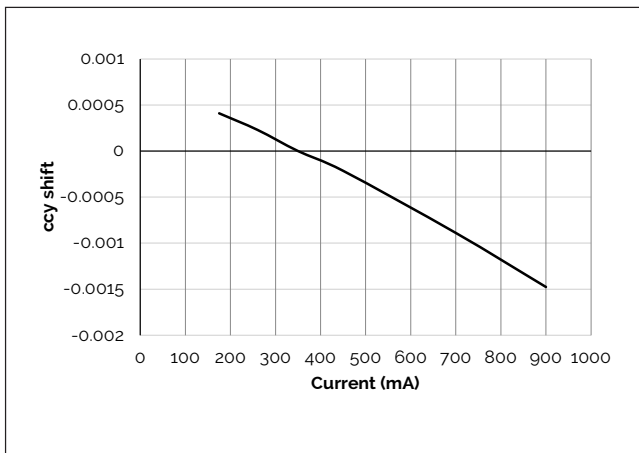

Figure 10: V13C Drive Current vs. ccx Shift

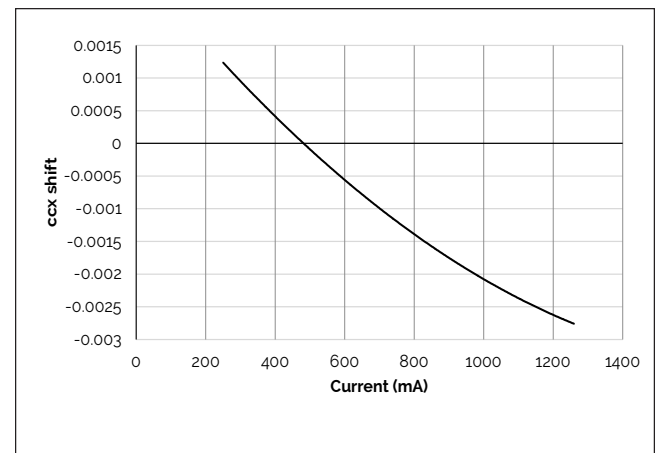

Figure 11: V13C Drive Current vs. ccy Shift

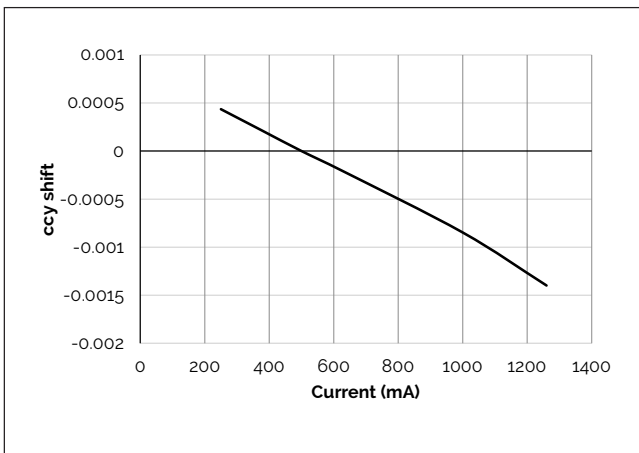
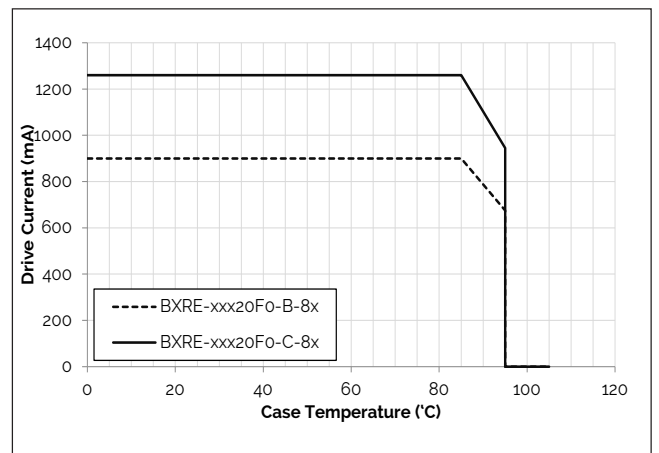

Figure 12: Derating Curve



Note for Figures 7-11:
1. Characteristics shown for Warm White.

Typical Radiation Pattern

Figure 13: Typical Spatial Radiation Pattern

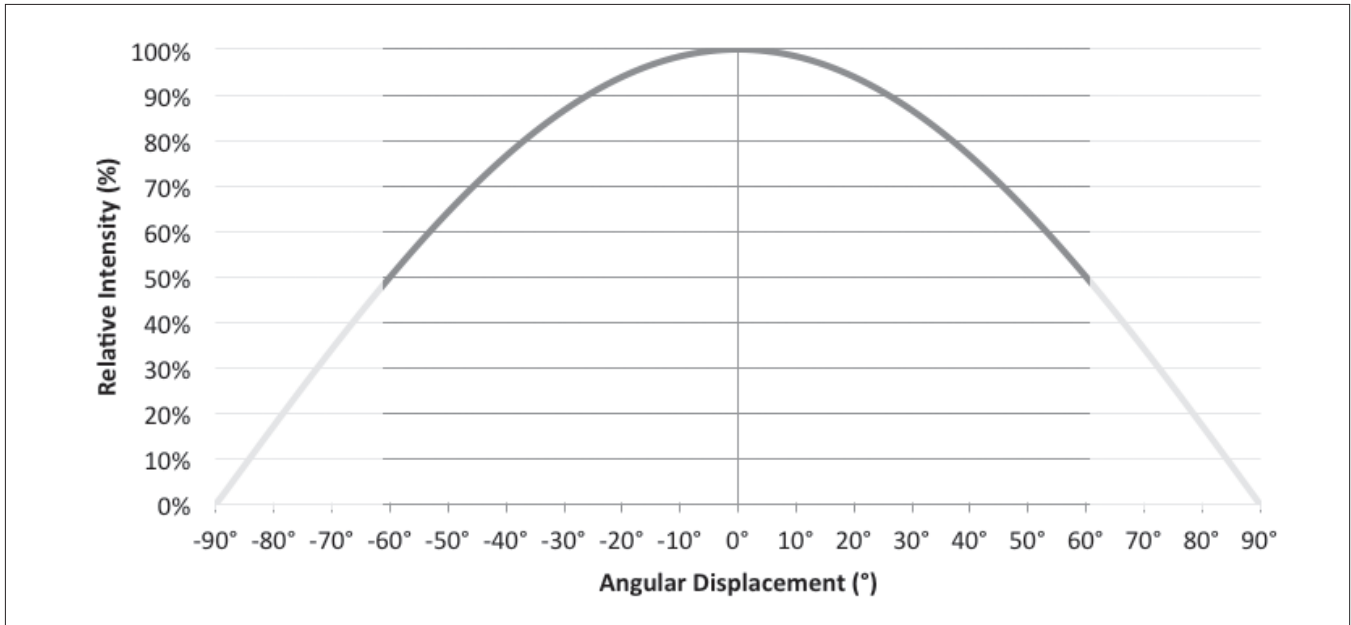

Notes for Figure 13:

1. Typical viewing angle is 120°.
2. The viewing angle is defined as the off axis angle from the centerline where intensity is ½ of the peak value.

Figure 14: Typical Polar Radiation Pattern

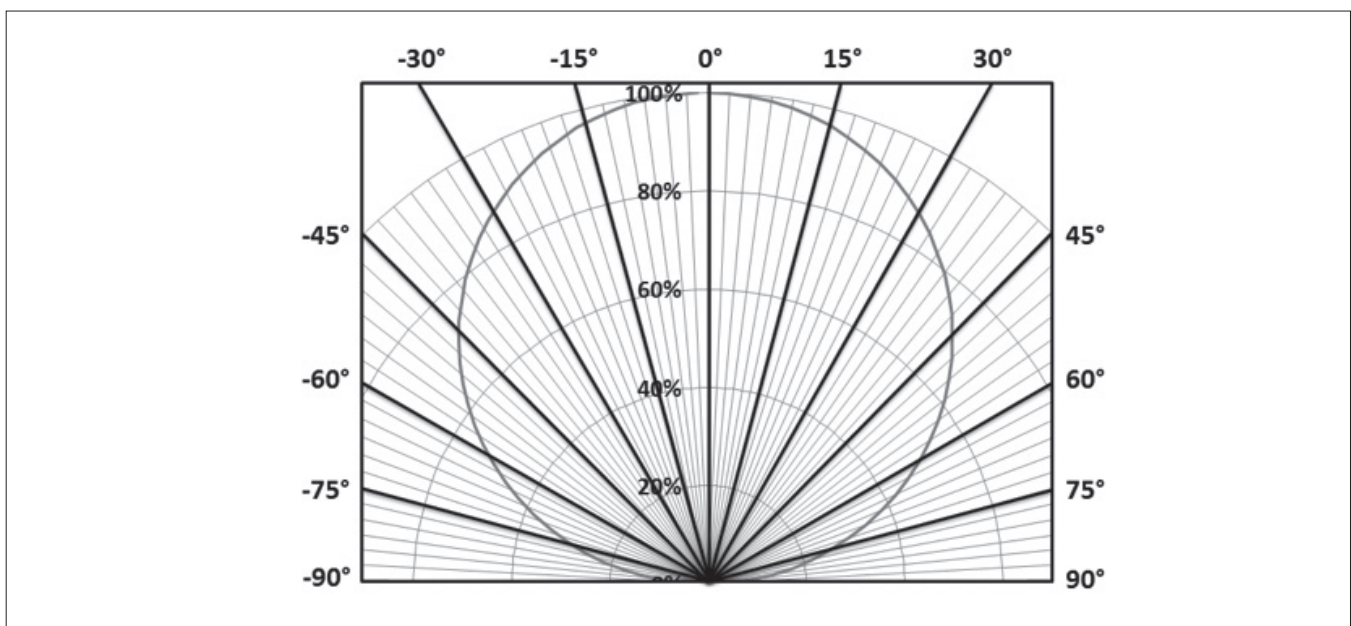

Typical Color Spectrum

Figure 15: Typical Color Spectrum

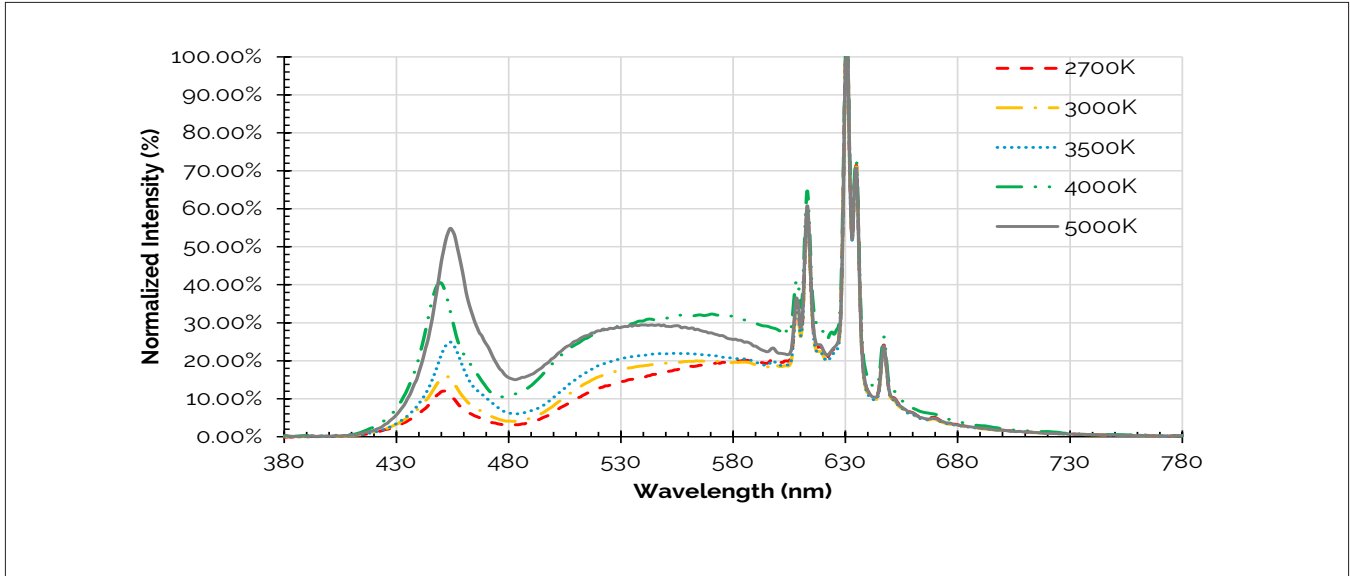

Notes for Figure 15:

1. Color spectra measured at nominal current for $T_j = T_c = 85^\circ\text{C}$.
2. Color spectra shown is 2700K and 90CRI.
3. Color spectra shown is 3000K and 90 CRI.
4. Color spectra shown is 3500K and 90 CRI.
5. Color spectra shown is 4000K and 90 CRI.
6. Color spectra shown is 5000K and 90 CRI.

Mechanical Dimensions

Figure 16: Drawing for V13 LED Array

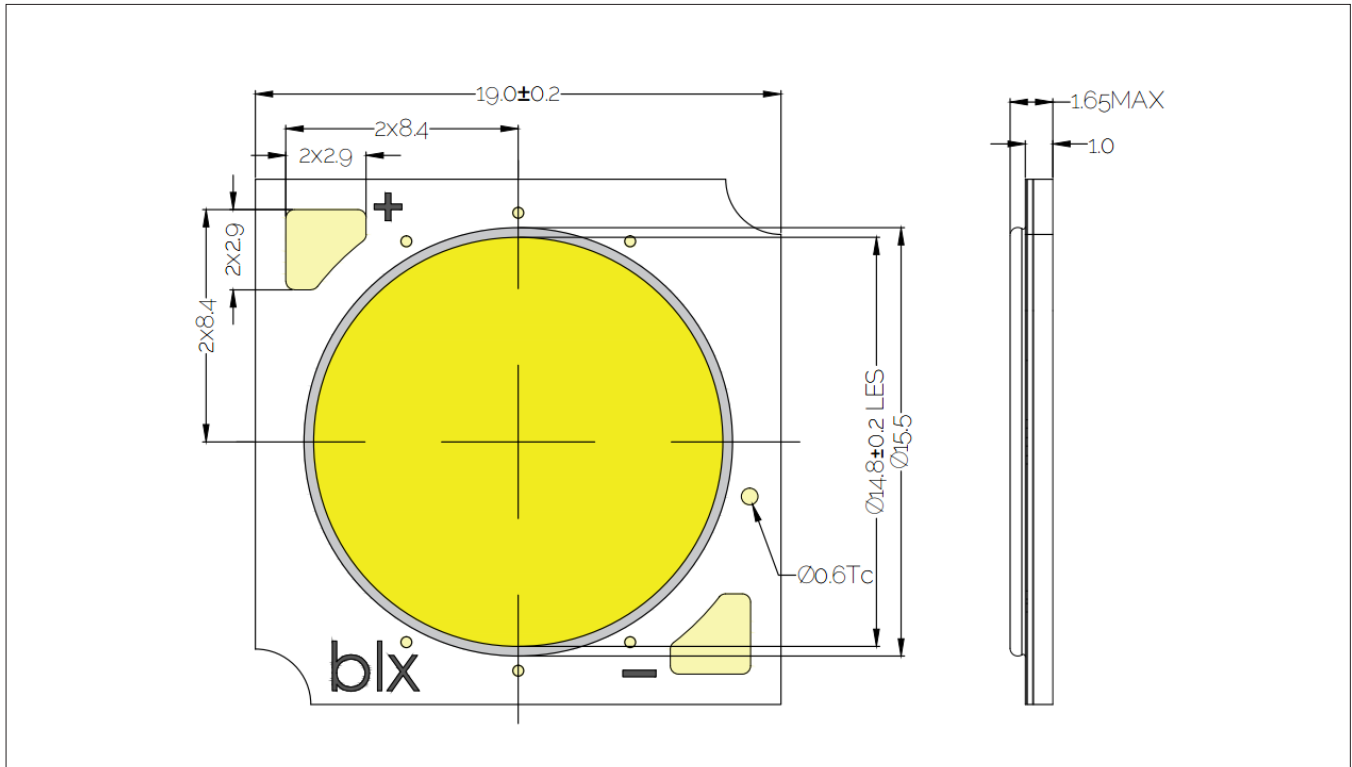

Color Binning Information

Figure 17: Warm and Neutral White Test Bins in xy Color Space

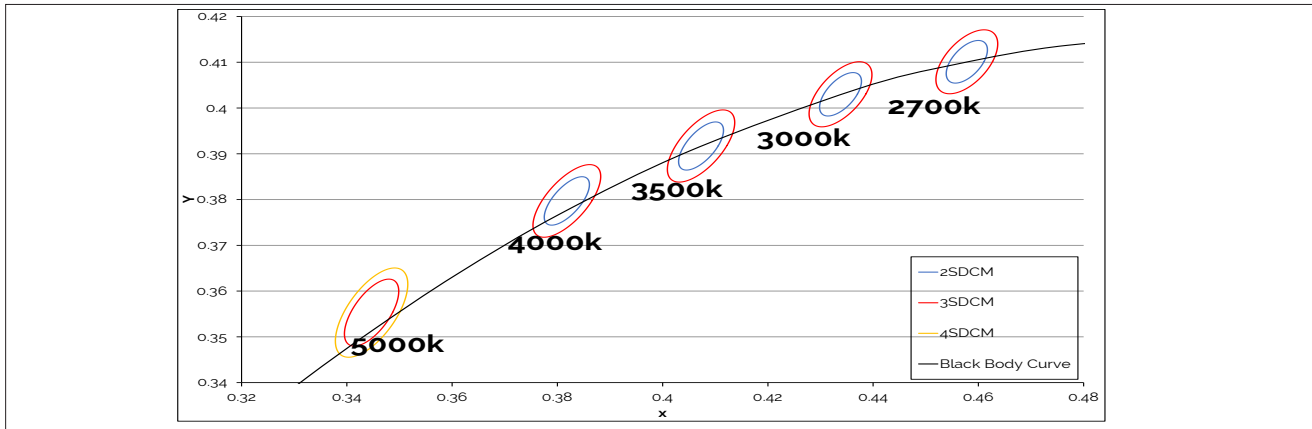

Note: Pulsed Test Conditions, $T_c = 85^\circ\text{C}$

Table 8: Warm and Neutral White xy Bin Coordinates and Associated Typical CCT (product is hot targeted to $T_c = 85^\circ\text{C}$)

| Bin Code | 2700K | 3000K | 3500K | 4000K |
|-------------------------------|------------------|-----------------|------------------|------------------|
| ANSI Bin (for reference only) | (2580K - 2870K) | (2870K - 3220K) | (3220K - 3710K) | (3710K - 4260K) |
| 83 (3 SDCM) | (2651K - 2794K) | (2968K - 3136K) | (3369K - 3586K) | (3851K - 4130K) |
| 82 (2 SDCM) | (2674K - 2769K) | (2995K - 3107K) | (3404K - 3548K) | (3895K - 4081K) |
| Center Point (x,y) | (0.4578, 0.4101) | (0.4338, 0.403) | (0.4073, 0.3917) | (0.3818, 0.3797) |

Table 9: Cool White xy Bin Coordinates and Associated Typical CCT (product is hot targeted to $T_c = 85^\circ\text{C}$)

| Bin Code | 5000K |
|-------------------------------|------------------|
| ANSI Bin (for reference only) | (4745K - 5311K) |
| 84 (4 SDCM) | (4801K - 5282K) |
| 83 (3 SDCM) | (4835K - 5215K) |
| Center Point (x,y) | (0.3447, 0.3553) |

Note for Tables 8-g:

1. Bridgelux maintains a tolerance of +/- 0.007 on x and y color coordinates in the CIE 1931 color Space.

Packaging and Labeling

Figure 18: Drawing for V13 Packaging Tubes



Notes for Figure 18:

1. Each tube holds 25 V13 COB arrays.
2. One tube is sealed in an anti-static bag. Four bags are placed in a shipping box. Depending on quantities ordered, a bigger shipping box, containing four boxes may be used to ship products.
3. Each bag and box is to be labeled as shown above.
4. Dimensions for each tube are 21.3 (W) x 9.5(H) x 505 (L). Dimensions for the anti-static bag are 75 (W) x 615 (L) x 3.1 (T) mm. Dimensions for the shipping box are 58.7 x 13.3 x 7.9 cm.

Packaging and Labeling

Figure 19: Gen. 8 Product Labeling

Bridgelux COB arrays have laser markings on the back side of the substrate to help with product identification. In addition to the product identification markings, Bridgelux COB arrays also contain markings for internal Bridgelux manufacturing use only. The image below shows which markings are for customer use and which ones are for Bridgelux internal use only. The Bridgelux internal manufacturing markings are subject to change without notice, however these will not impact the form, function or performance of the COB array.

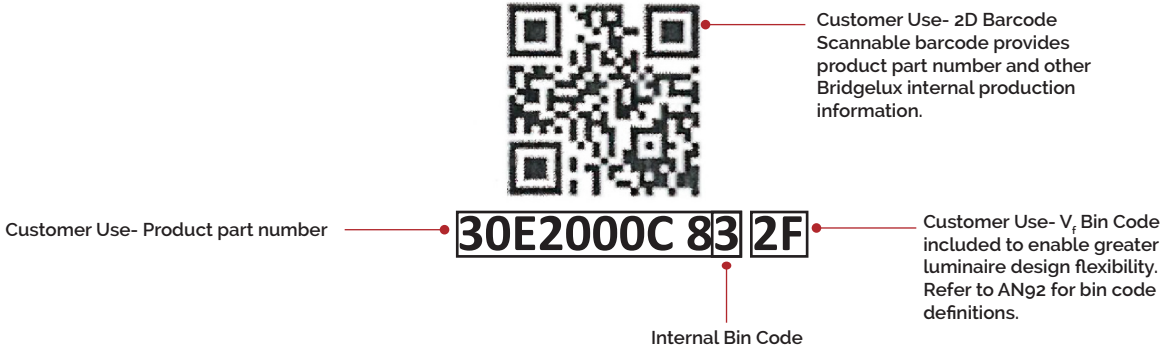

Design Resources

Application Notes

Bridgelux has developed a comprehensive set of application notes and design resources to assist customers in successfully designing with the V Series product family of LED array products. For all available application notes visit www.bridgelux.com.

Optical Source Models

Optical source models and ray set files are available for all Bridgelux products. For a list of available formats, visit www.bridgelux.com.

3D CAD Models

Three dimensional CAD models depicting the product outline of all Bridgelux V Series LED arrays are available in both IGS and STEP formats. Please contact your Bridgelux sales representative for assistance.

LM80

LM80 testing has been completed and the LM80 report is now available. Please contact your Bridgelux sales representative for LM-80 report.

Precautions

CAUTION: CHEMICAL EXPOSURE HAZARD

Exposure to some chemicals commonly used in luminaire manufacturing and assembly can cause damage to the LED array. Please consult Bridgelux Application Note AN101 for additional information.

CAUTION: RISK OF BURN

Do not touch the V Series LED array during operation. Allow the array to cool for a sufficient period of time before handling. The V Series LED array may reach elevated temperatures such that could burn skin when touched.

CAUTION

CONTACT WITH LIGHT EMITTING SURFACE (LES)

Avoid any contact with the LES. Do not touch the LES of the LED array or apply stress to the LES (yellow phosphor resin area). Contact may cause damage to the LED array.

Optics and reflectors must not be mounted in contact with the LES (yellow phosphor resin area).

Disclaimers

MINOR PRODUCT CHANGE POLICY

The rigorous qualification testing on products offered by Bridgelux provides performance assurance. Slight cosmetic changes that do not affect form, fit, or function may occur as Bridgelux continues product optimization.

STANDARD TEST CONDITIONS

Unless otherwise stated, array testing is performed at the nominal drive current.

About Bridgelux: Bridging Light and Life™

At Bridgelux, we help companies, industries and people experience the power and possibility of light. Since 2002, we've designed LED solutions that are high performing, energy efficient, cost effective and easy to integrate. Our focus is on light's impact on human behavior, delivering products that create better environments, experiences and returns—both experiential and financial. And our patented technology drives new platforms for commercial and industrial luminaires.

For more information about the company, please visit
bridgelux.com
twitter.com/Bridgelux
facebook.com/Bridgelux
youtube.com/user/Bridgelux
linkedin.com/company/bridgelux-inc-_2
WeChat ID: BridgeluxInChina



46410 Fremont Boulevard
Fremont, CA 94538 U.S.A.
Tel (925) 583-8400
www.bridgelux.com

© 2022 Bridgelux, Inc. All rights reserved. Product specifications are subject to change without notice. Bridgelux, the Bridgelux stylized logo design and Vero are registered trademarks. V Series and Decor Series are trademarks of Bridgelux, Inc. All other trademarks are the property of their respective owners.

Bridgelux V13 F90 Array Series Product Data Sheet DS447 Rev. B (11/2022)