



Bridgelux® Vesta® SE Series Dim-To-Warm Gen1 13mm Integrated Array with S2 Holder

Product Data Sheet DS372



Product Feature Map

Bridgelux arrays are fully engineered devices that provide consistent thermal and optical performance on an engineered mechanical platform. The arrays incorporate several features to simplify design integration and assembly. Please visit www.bridgelux.com for more information on the Vesta SE Series family of products.

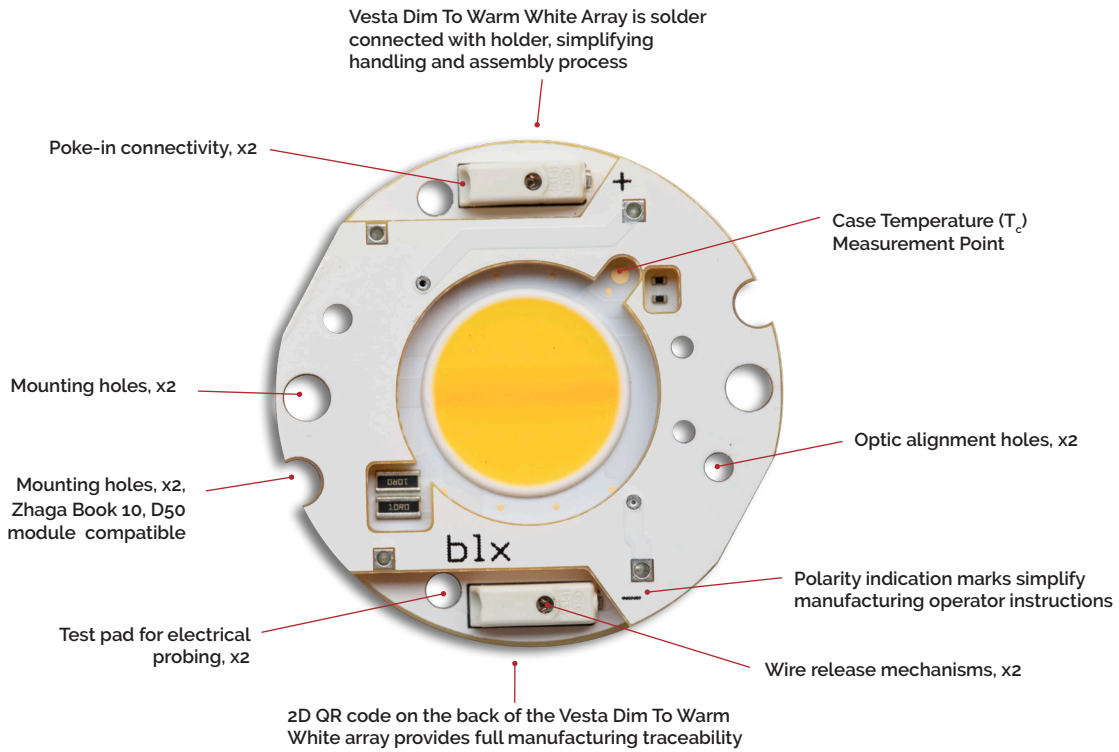

Product Nomenclature

The part number designation for Bridgelux Vesta SE Series arrays is explained as follows:

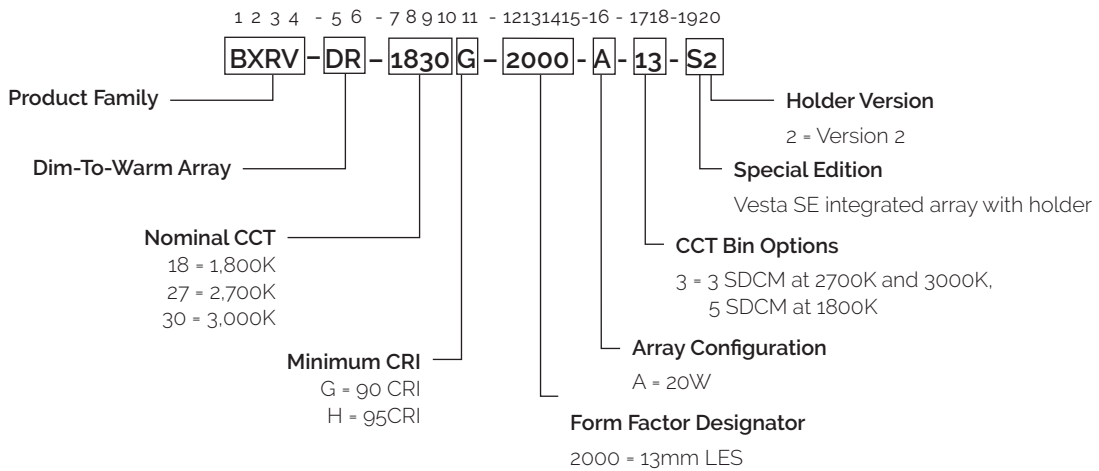

Product Selection Guide

The following product configurations are available:

Table 1: Selection Guide, Measurement Data

Part Number	Nominal CCT ¹ T _c =25°C (K)	Minimum CRI ²	Drive Current (mA)	Typical V _f T _c =25°C (V)	Typical Power T _c =25°C (W)	Typical Pulsed Flux ^{3,4,5} T _c =25°C (lm)	Typical Efficacy T _c =25°C (lm/W)	Minimum Pulsed Flux ⁶ T _c =25°C (lm)	Typical DC Flux ^{7,8} T _c =85°C (lm)
BXRV-DR-1827G-2000-A-13-S2	2700	90	600	33.5	20.1	2071	103	1864	1864
	1800	90	20	26.9	0.5	43	80	39	39
BXRV-DR-1827H-2000-A-13-S2	2700	95	600	33.5	20.1	1831	91	1648	1648
	1800	93	20	26.9	0.5	36	67	32	32
BXRV-DR-1830G-2000-A-13-S2	3000	90	600	33.5	20.1	2238	111	2014	2014
	1800	90	20	26.9	0.5	52	96	46	46
BXRV-DR-1830H-2000-A-13-S2	3000	95	600	33.5	20.1	1942	97	1747	1747
	1800	93	20	26.9	0.5	43	80	39	39

Notes for Table 1:

- Nominal CCT as defined by ANSI C78.377-2017.
- Minimum R_g value for 90/90 CRI products is 50. Minimum R_g value for 93/95 CRI products is 85. Bridgelux maintains a ±3 tolerance on all CRI and R_g values.
- Products tested under pulsed condition (10ms pulse width) at nominal test current where T_j (junction temperature) - T_c (case temperature) = 25°C.
- Typical performance values are provided as a reference only and are not a guarantee of performance.
- Bridgelux maintains a ±7% tolerance on flux measurements.
- Minimum flux values at the nominal test current are guaranteed by 100% test.
- Typical stabilized DC performance values are provided as reference only and are not a guarantee of performance.
- Typical performance is estimated based on operation under DC (direct current) with LED array mounted onto a heat sink with thermal interface material and the case temperature maintained at 85°C. Based on Bridgelux test setup, values may vary depending on the thermal design of the luminaire and/or the exposed environment to which the product is subjected.

European Product Registry for Energy Labeling

The European Product Registry for Energy Labeling (EPREL) is defined in the EU Regulation 2017/1369 to provide information about a product's energy efficiency to consumers. Together with Energy Labeling Regulation ELR (EU) 2019/2015, which was amended by regulation (EU) 2021/340 for energy labelling of light sources, manufacturers are required to declare an energy class based on key technical specifications from each of their product and register it in an open data base managed by EPREL. It is now a legal requirement for a vendor of light sources to upload information about their products into the EPREL database before placing these products on the market in the EU.

Table 2 provides a list of part numbers that are in compliance with EPREL regulations and are currently listed in the EPREL database.

At Bridgelux, we are fully committed to supplying products that are compliant with pertinent laws, rules, and obligation imposed by relevant government bodies including the ELR regulation. Customers can use these products with full confidence for any projects that fall under the EPREL requirement.

Table 2: Table of products registered in the European Product Registry for Energy Labeling (EPREL)

Part Number	CCT (K)	CRI	Current ³ (mA)	Voltage ³ (V)	Useful Flux ² Φ_{useful} Tc=85°C (lm)	Power (W)	Efficacy (lm/W)	Energy Efficiency Class ⁴	Registration No	URL ⁵
BXRV-DR-1827G-2000-A-13-S2	2700	90	400	31.0	1113	12.4	89	G 	876470	https://tinyurl.com/t8yast5h
BXRV-DR-1827H-2000-A-13-S2	2700	95	250	29.9	634	7.5	84	G	876484	https://tinyurl.com/3dva5t95
BXRV-DR-1830G-2000-A-13-S2	3000	90	720	33.2	2006	24.0	83	G	876501	https://tinyurl.com/7fzv585c
BXRV-DR-1830H-2000-A-13-S2	3000	95	320	30.4	848	9.7	87	G	876515	https://tinyurl.com/4mua2wc8

Notes for Table 2:

1. The performance data in this table is a subset of the data that was submitted to EPREL for obtaining the energy class listed here. For accessing a complete set of technical documentation of Bridgelux registered products in the EPREL database, please visit one of the hyperlinks listed above.
2. For a definition of useful luminous flux (Φ_{useful}), please see the ELR regulations at <https://tinyurl.com/4b6zvt4m>.
3. For information on performance values at alternative drive conditions, please refer to the Product Selection Guide, Absolute Maximum Rating Table and Performance Curves in this data sheet.
4. EPREL requires a symbol for displaying the energy classification of a product in marketing literature. This symbol consists of a letter stating a product's energy efficiency class inside a specific arrow logo as defined by EPREL.
5. All products listed here must be disposed as e-waste according to the guidelines in the country in which the product is used.

Electrical Characteristics

Table 3: Electrical Characteristics

Part Number	Drive Current (mA)	Forward Voltage Pulsed, $T_c = 25^\circ\text{C}$ ^{1, 2, 3, 7}			Typical Coefficient of Forward Voltage $\Delta V_f / \Delta T_c$ (mV/ $^\circ\text{C}$)	Typical Thermal Resistance Junction to Case ^{4, 5} ($^\circ\text{C}/\text{W}$)	Driver Selection Voltages ⁶	
		Minimum (V)	Typical (V)	Maximum (V)			V_f Min. Hot $T_c = 105^\circ\text{C}$ (V)	V_f Max. Cold $T_c = -40^\circ\text{C}$ (V)
BXRV-DR-18xxx-2000-A-13-S2	600	31.0	33.5	36.0	-12.1	0.23	30.0	36.8
	720	31.5	34.0	36.6	-12.1	0.25	30.5	37.4

Notes for Table 3:

- Parts are tested in pulsed conditions, $T_c = 25^\circ\text{C}$. Pulse width is 10ms.
- Voltage minimum and maximum are provided for reference only and are not a guarantee of performance.
- Bridgelux maintains a tester tolerance of $\pm 0.10\text{V}$ on forward voltage measurements.
- Typical coefficient of forward voltage tolerance is $\pm 0.1\text{mV}$ for nominal current.
- Thermal resistance value was calculated using total electrical input power; optical power was not subtracted from input power. The thermal interface material used during testing is not included in the thermal resistance value.
- V_f min hot and max cold values are provided as reference only and are not guaranteed by test. These values are provided to aid in driver design and selection over the operating range of the product.
- This product has been designed and manufactured per IEC 62031:2018. This product has passed dielectric withstand voltage testing at 500 V. The working voltage designated for the insulation is 60V d.c. The maximum allowable voltage across the array must be determined in the end product application.

Absolute Maximum Ratings

Table 4: Maximum Ratings

Parameter	Maximum Rating
LED Junction Temperature (T_j)	125°C
Storage Temperature	-40°C to +105°C
Operating Case Temperature ¹ (T_c)	105°C
Maximum Drive Current ³	720mA
Maximum Peak Pulsed Drive Current ⁴	1030mA
Maximum Reverse Voltage ⁵	-60V

Notes for Table 4:

1. For IEC 62717 requirement, please contact Bridgelux Sales Support.
2. See Bridgelux Application Note AN101 "Handling and Assembly of LED Arrays" for more information.
3. Please refer to Figures 8 for drive current derating curves.
4. Bridgelux recommends a maximum duty cycle of 10% and pulse width of 20ms when operating LED arrays at the maximum peak pulsed current specified. Maximum peak pulsed currents indicate values where the LED array can be driven without catastrophic failures.
5. Light emitting diodes are not designed to be driven in reverse voltage and will not produce light under this condition. Maximum rating provided for reference only.

Performance Curves

Figure 1: CCT vs. Forward Current 2700K-1800K

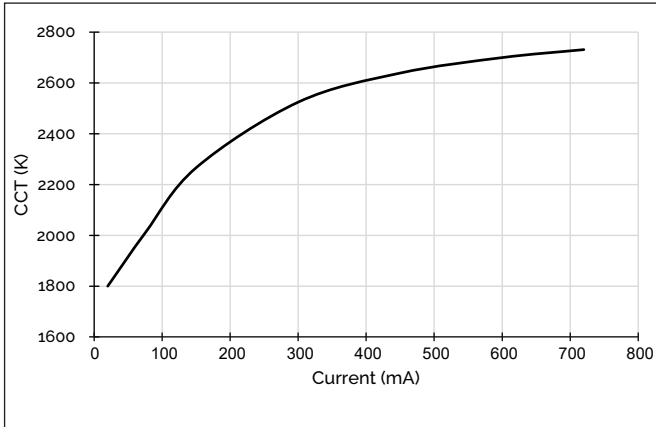

Figure 2: CCT vs. Forward Current 3000K-1800K

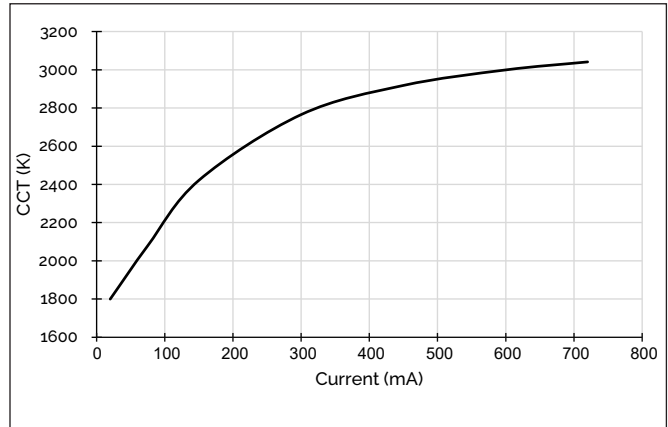

Figure 3: Color Shift vs. Forward Current 2700K - 1800K

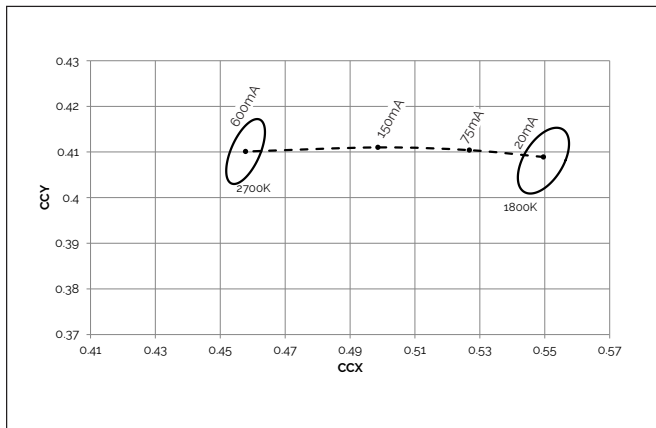

Figure 4: Color Shift vs. Forward Current 3000K - 1800K

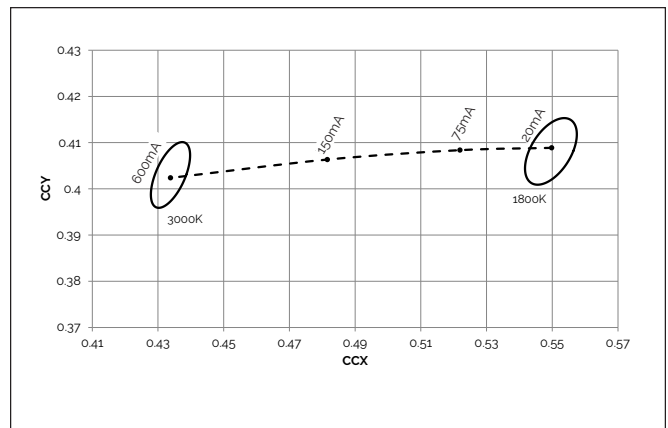
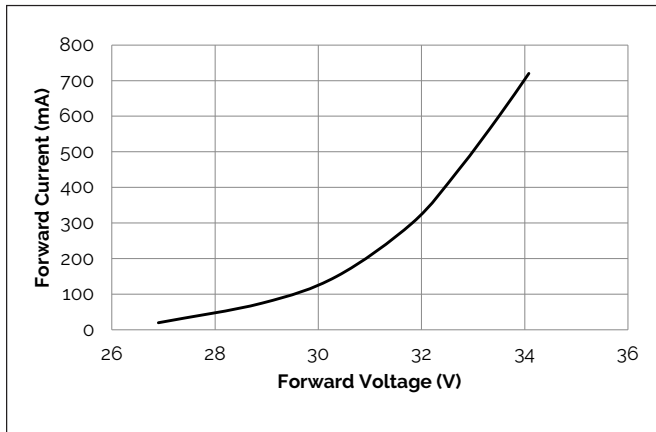

Figure 5: Forward Voltage vs. Forward Current, $T_c = 25^\circ\text{C}$



Performance Curves

Figure 6: Relative LOP vs. Drive Current, $T_c=25^\circ\text{C}$

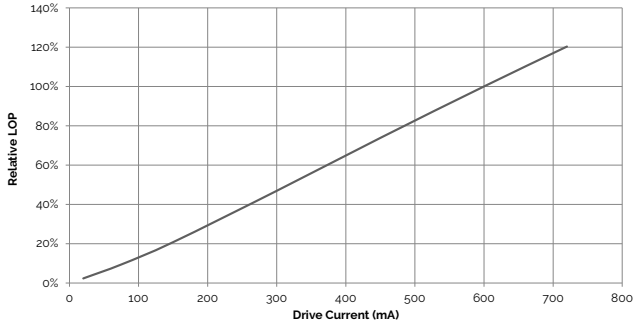

Figure 7: Relative Flux vs. Case Temperature

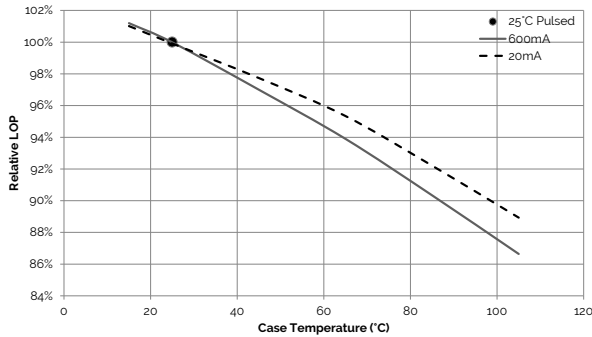
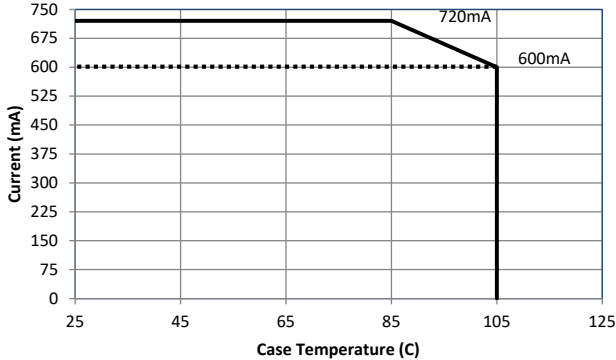
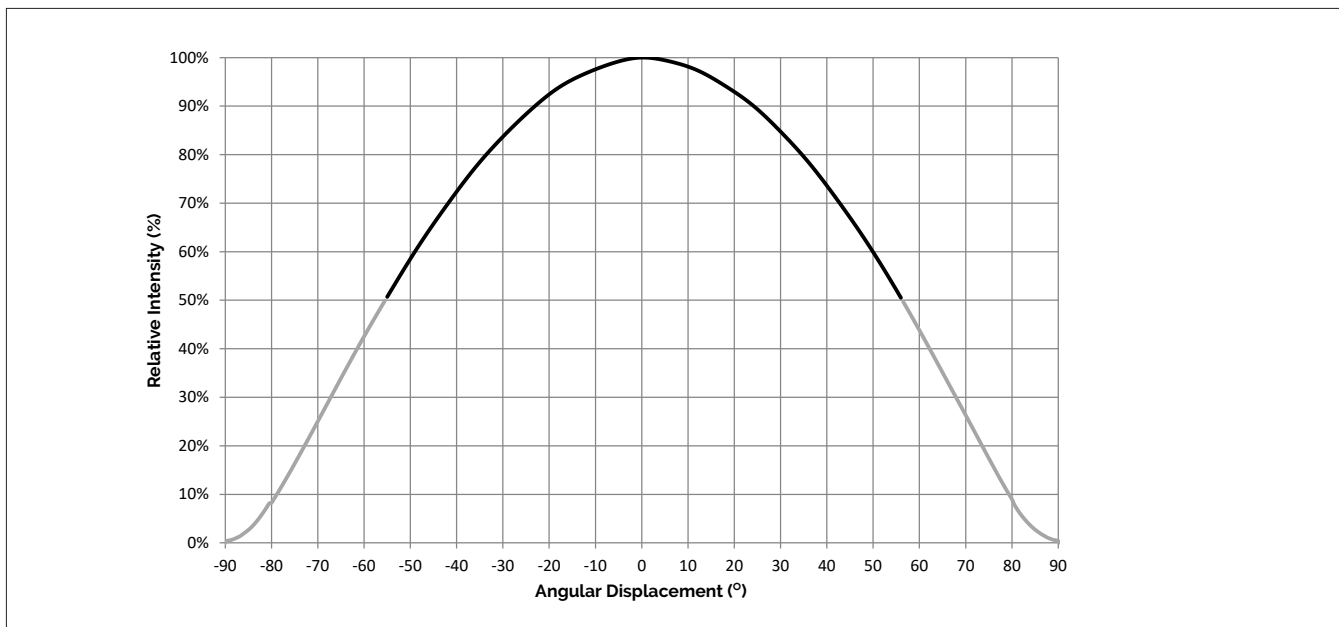

Figure 8: Derating Curve



Typical Radiation Pattern

Figure 9: Typical Spatial Radiation Pattern



Notes for Figure 9:

1. Typical viewing angle is 110°.
2. The viewing angle is defined as the off axis angle from the centerline where Iv is 1/2 of the peak value.

Figure 10: Typical Polar Radiation Pattern

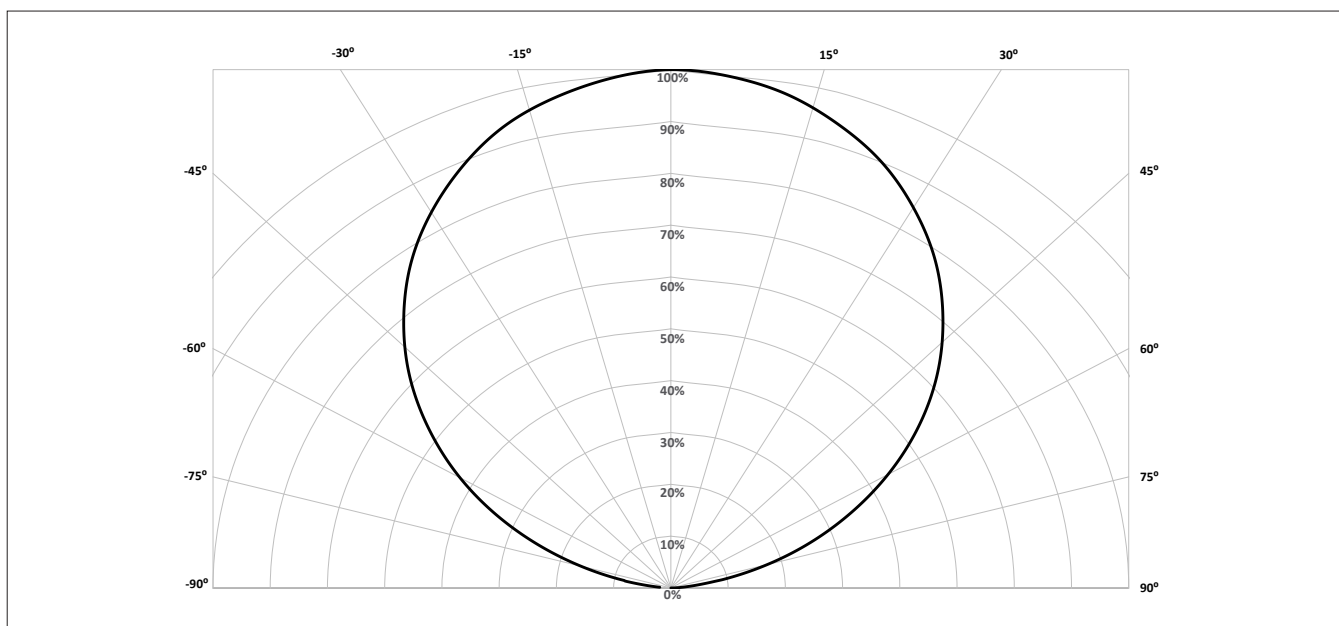

Typical Color Spectrum

Figure 11: Typical Color Spectrum

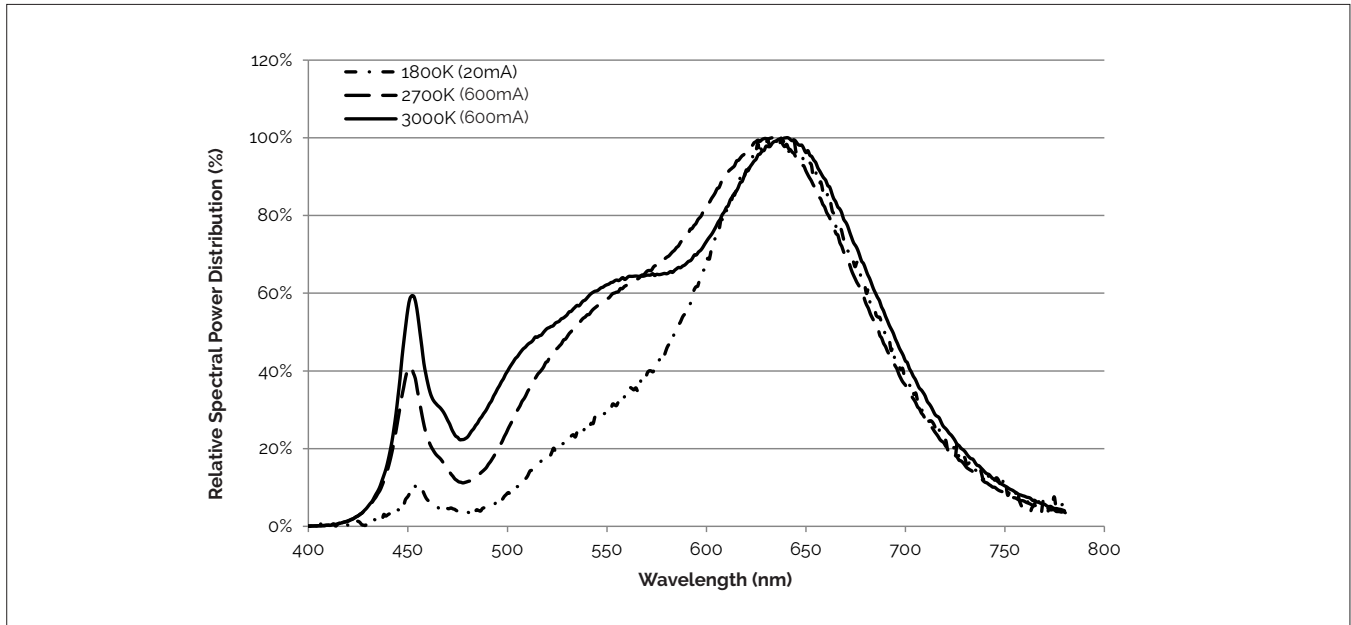

Note for Figure 11:

1. Color spectra measured at nominal current for $T_c = 25^\circ\text{C}$.

Mechanical Dimensions

Figure 12: Mechanical Drawing Specification

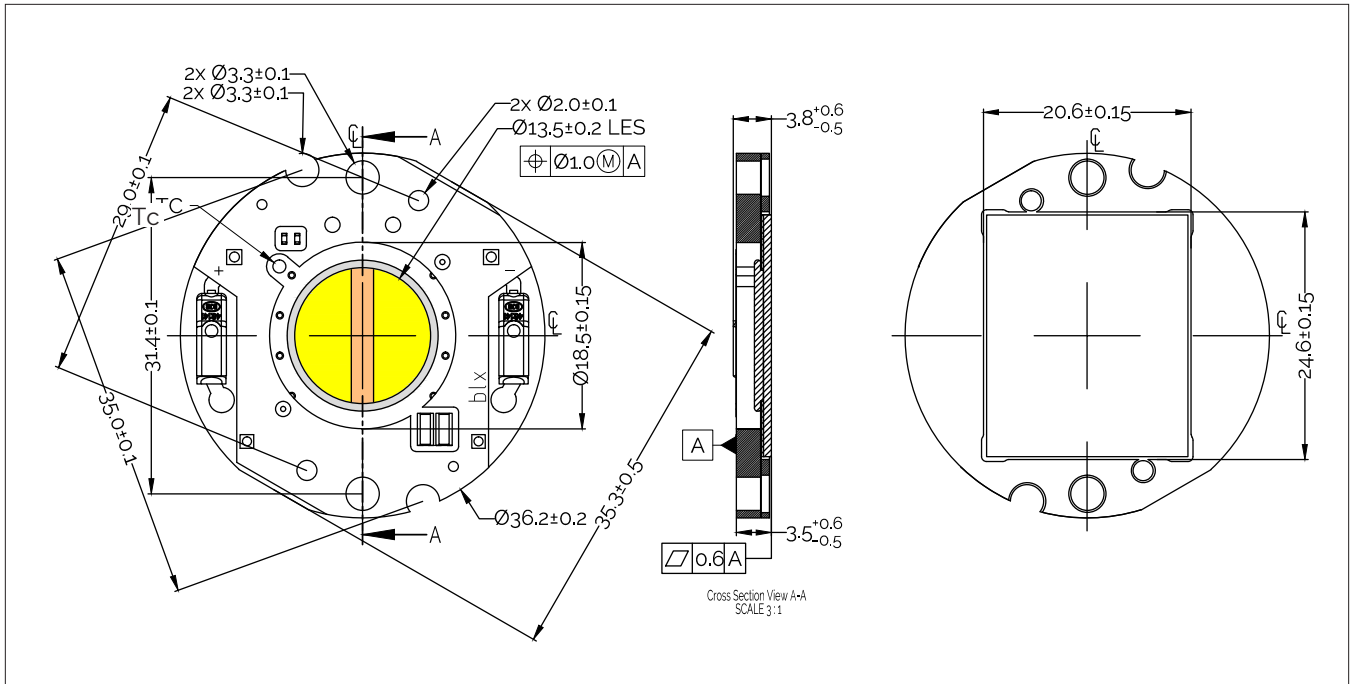

Notes for Figure 12::

1. Connectors are labeled "+" to denote positive polarity and "-" to denote negative polarity
2. Poke-In connectors accept solid and stranded wires with AWG wire sizes 20 - 24
3. Recommended wire strip length is 7.0mm +/-0.5mm
4. Wires may be released by pushing into the wire release hole on the poke in connector. Bridgelux recommends the use of BJB tool 46.141.U801.8g
5. Mounting holes (2X) are for M3 screws
6. Bridgelux recommends two tapped holes for mounting screws with 31.4 ± 0.10mm center-to-center spacing
7. Screws with flat shoulders (pan, dome, button, round, truss, mushroom) provide optimal torque control. Do not use flat, countersink, or raised head screws
8. The maximum mounting screw torque value is 0.3 N-m (2.7 lbf-in)
9. Drawings are not to scale
10. Drawing dimensions are in millimeters
11. Unless otherwise specified, tolerances are ± 0.10mm

Color Binning Information

Table 5: McAdam ellipse CCT color bin definitions for product operating at $T_c = 25^\circ\text{C}$

CCT	Center Point	Bin Size	Axis a	Axis b	Rotation Angle
1800K	x=0.5496 y=0.4081	5 SDCM	0.01164	0.00655	40.00°
2700K	x=0.4578 y= 0.4101	3 SDCM	0.00810	0.00420	53.70°
3000K	x=0.4338 y=0.4030	3 SDCM	0.00834	0.00408	53.22°

Notes for Table 5:

1. The x,y center points are the center points of the respective ANSI bins in the CIE 1931 xy Color Space
2. Products are binned at $T_c=25^\circ\text{C}$
3. Bridgelux maintains a tolerance of +/-0.007 on x and y color coordinates in the CIE 1931 Color Space

Figure 13: Definition of the McAdam ellipse

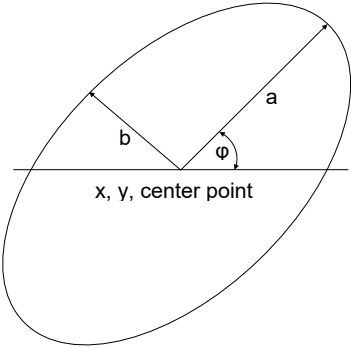

Packaging and Labeling

Figure 14: Packaging Specifications

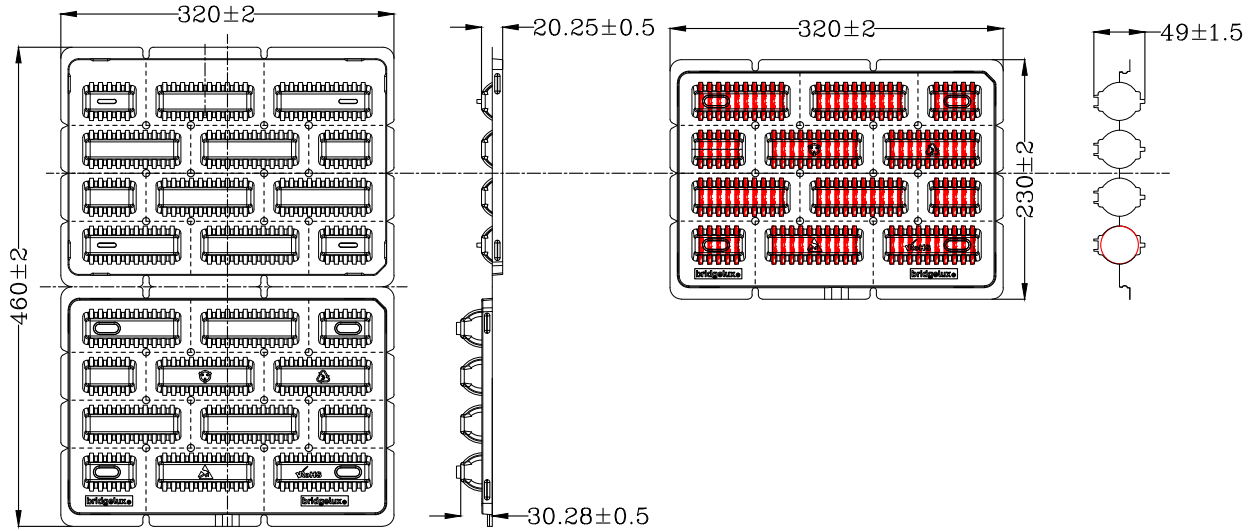

Notes for Figure 14:

1. Each plastic tray holds 100 arrays
2. Each tray is sealed in an anti-static bag. One such bag is placed in a small box and shipped. Depending on quantities ordered, a bigger shipping box containing multiple small boxes may be used to ship products.
3. Each bag and small box is labeled as shown above.
4. The dimensions of the small shipping box are 350 x 245 x 67 mm.

Figure 15: Product Labeling

Bridgelux arrays have laser markings on the back side of the substrate to help with product identification. In addition to the product identification markings, Bridgelux arrays also contain markings for internal Bridgelux manufacturing use only. The image below shows which markings are for customer use and which ones are for Bridgelux internal use only. The Bridgelux internal manufacturing markings are subject to change without notice, however these will not impact the form, function or performance of the array.



Design Resources

Application Notes

Bridgelux has developed a comprehensive set of application notes and design resources to assist customers in successfully designing with the Vesta Series product family of LED array products. Please see Bridgelux Application Note, AN101 for more information. For a list of resources under development, visit www.bridgelux.com.

Optical Source Models

Optical source models and ray set files are available for all Bridgelux products. For a list of available formats, visit www.bridgelux.com.

3D CAD Models

Three dimensional CAD models depicting the product outline of all Bridgelux Vesta Series LED arrays are available in both IGES and STEP formats. Please contact your Bridgelux sales representative for assistance.

LM80

LM80 testing has been completed and the LM80 report is now available. Please contact your Bridgelux sales representative for LM-80 report.

Precautions

CAUTION: CHEMICAL EXPOSURE HAZARD

Exposure to some chemicals commonly used in luminaire manufacturing and assembly can cause damage to the LED array. Please consult Bridgelux Application Note, AN101 for additional information.

CAUTION: EYE SAFETY

Eye safety classification for the use of Bridgelux Vesta Series is in accordance with IEC/TR62778: Application of IEC 62471 for the assessment of blue light hazard to light sources and luminaires. Vesta Series Dim-To-Warm arrays are classified as Risk Group 1 when operated at or below the maximum drive current. Please use appropriate precautions. It is important that employees working with LEDs are trained to use them safely.

CAUTION: RISK OF BURN

Do not touch the Vesta Series LED array during operation. Allow the array to cool for a sufficient period of time before handling. The Vesta Series LED array may reach elevated temperatures such that could burn skin when touched.

CAUTION

CONTACT WITH LIGHT EMITTING SURFACE (LES)

Avoid any contact with the LES and resistors. Do not touch the LES or resistors of the LED array or apply stress to the LES (yellow phosphor resin area). Contact may cause damage to the LED array.

Secondary optics may be mounted on the top surface of the Vesta Series SE array as long as they do not make contact with the LES. Use the holder alignment holes to align and mount secondary optics devices.

Disclaimers

STANDARD TEST CONDITIONS

Unless otherwise stated, array testing is performed at the nominal drive current.

MINOR PRODUCT CHANGE POLICY

The rigorous qualification testing on products offered by Bridgelux provides performance assurance. Slight cosmetic changes that do not affect form, fit, or function may occur as Bridgelux continues product optimization.

About Bridgelux: Bridging Light and Life™

At Bridgelux, we help companies, industries and people experience the power and possibility of light. Since 2002, we've designed LED solutions that are high performing, energy efficient, cost effective and easy to integrate. Our focus is on light's impact on human behavior, delivering products that create better environments, experiences and returns—both experiential and financial. And our patented technology drives new platforms for commercial and industrial luminaires.

For more information about the company, please visit

bridgelux.com

twitter.com/Bridgelux

facebook.com/Bridgelux

youtube.com/user/Bridgelux

linkedin.com/company/bridgelux

WeChat ID: BridgeluxInChina



46410 Fremont Blvd
Fremont, CA 94538 USA
Tel (925) 583-8400
www.bridgelux.com

© 2021 Bridgelux, Inc. All rights reserved 2021. Product specifications are subject to change without notice. Bridgelux, the Bridgelux stylized logo design and Vesta are registered trademarks of Bridgelux, Inc. All other trademarks are the property of their respective owners.

Bridgelux Vesta Series SE Dim-To-Warm 13mm Array with S2 Holder Product Data Sheet DS372 Rev. B (08/2021)