

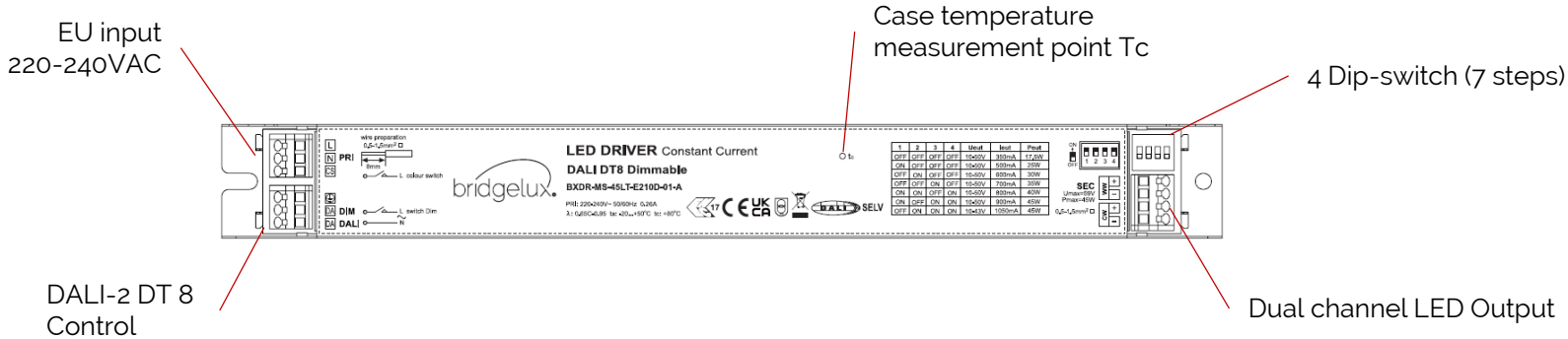

# Product Feature Map

Bridgelux Vesta-D (DALI) Dual Channel 45W Driver provides two dynamic constant current outputs for dual channel CCT tunable LED modules and arrays. This Driver interoperates with DALI-2 standard lighting systems and protocols and allows for simple integration of Vesta Flex Tunable White Arrays and Linear modules. Please visit [www.bridgelux.com](http://www.bridgelux.com) for more information.



## Product Nomenclature

The part number designation for Bridgelux Vesta-D (DALI) Dual Channel 45W Driver is explained as follows:

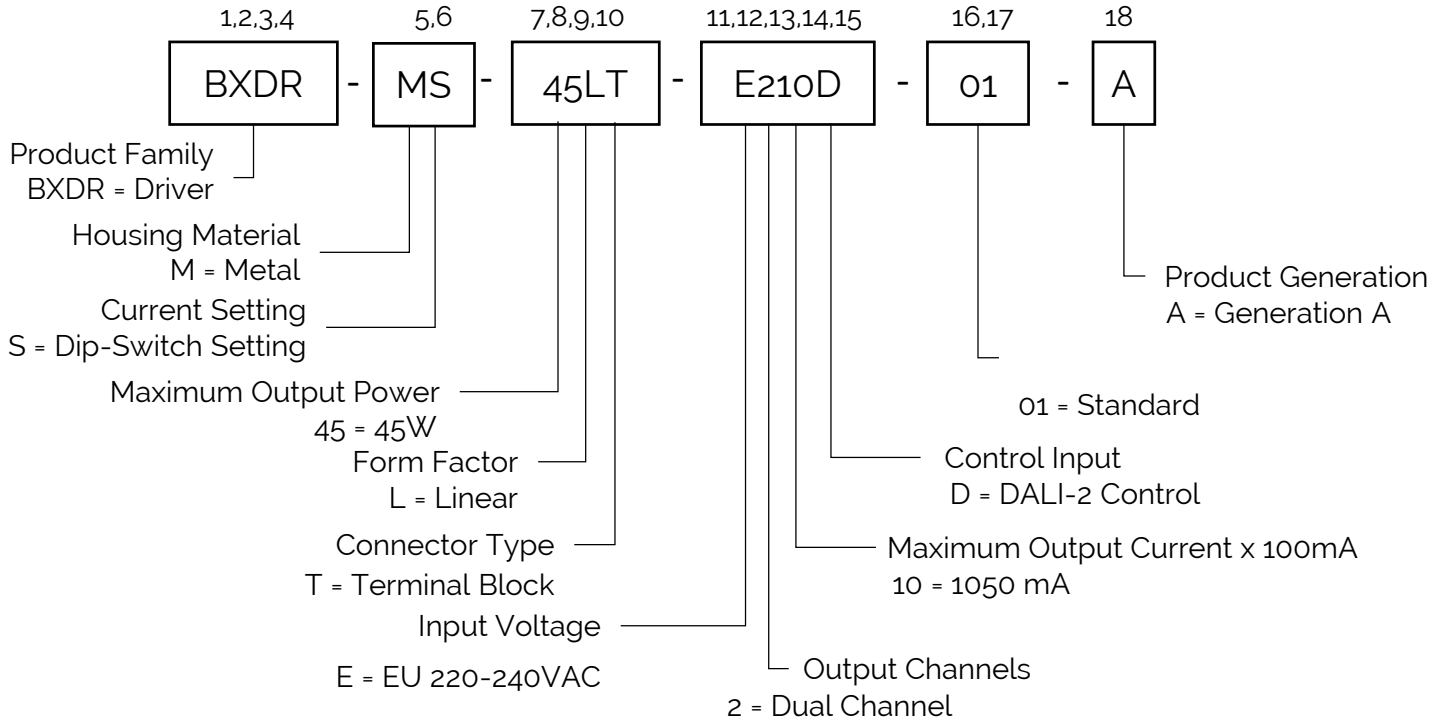

Table 1: Product Selection Guide

Part Number	Configuration
BXDR-MS-45LT-E210D-01-A	Linear

# Electrical Characteristics

Table 2: Input Electrical Characteristics

Parameter	Unit	Specification
Nominal voltage	V	220 – 240
Nominal frequency	Hz	0 / 50 / 60
AC voltage range	V	198 – 264
DC voltage range	V	176-370
Nominal current	A	0.26
THD (Full load)	%	≤ 15
Power factor (Full load)	-	≥ 0.95
Efficiency (Full load)	%	87
NO load	W	≤ 0.5
Protection class	-	II
Inrush current(Cold start)	A pk	< 30 (th = 100 μs)
Max. units per circuit breaker	-	B10: 23 B16: 37 C10: 46 C16: 74

Table 3: Output Electrical Characteristics

Parameter	Unit	Specification						
Nominal voltage range	V	10-50	10-50	10-50	10-50	10-50	10-50	10-43
Maximum voltage(Open Circuit)	Vdc	≤ 59						
Nominal current	mA	350	500	600	700	800	900	1050
Current accuracy	%	+/- 5						
Current ripple LF < 200Hz	%	≤ 3						
Pst LM	-	≤ 1						
SVM	-	≤ 0.4						
Maximum power	W	45						
Galvanic isolation	-	SELV						

# Electrical Characteristics

Figure 1: Power Factor vs. Load

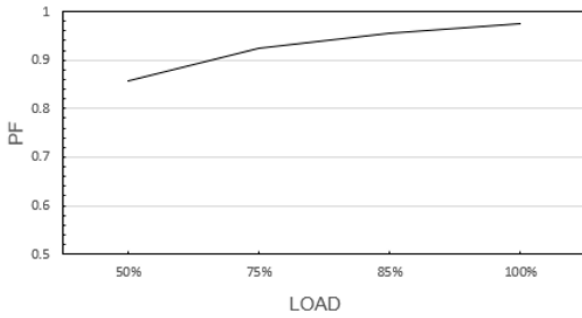

Figure 2: Total Harmonic Distortion vs. Load

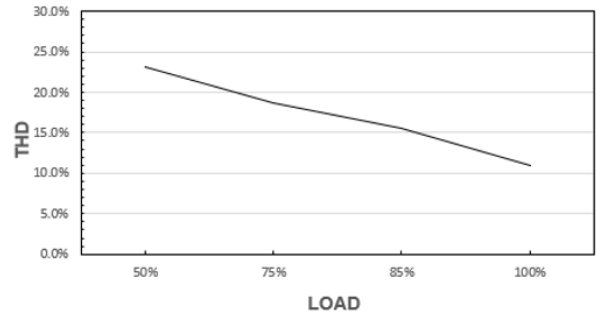

Figure 3: Efficiency vs. Load

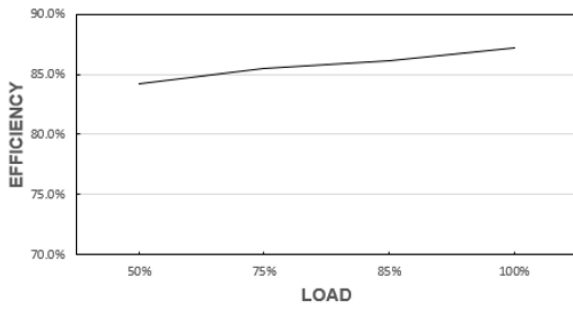
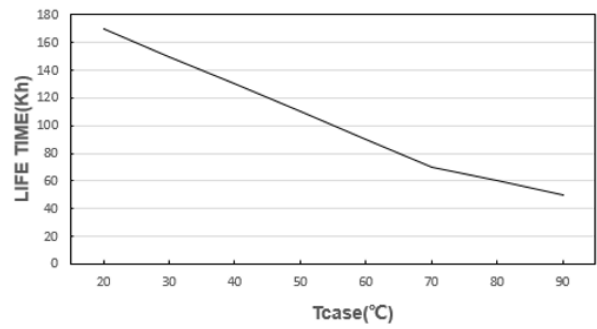

Figure 4: Expected Life Time



# Mechanical Characteristics

Table 4: Product Selection Guide

Characteristics	Specification
Dimensions	280.0 mm (L) x 31.5 mm (W) x 22.0 mm (H)
Enclosure Materials	Steel Metal
Weight	245 g
Ingress Protection	IP20

Figure 5: Mechanical Drawing

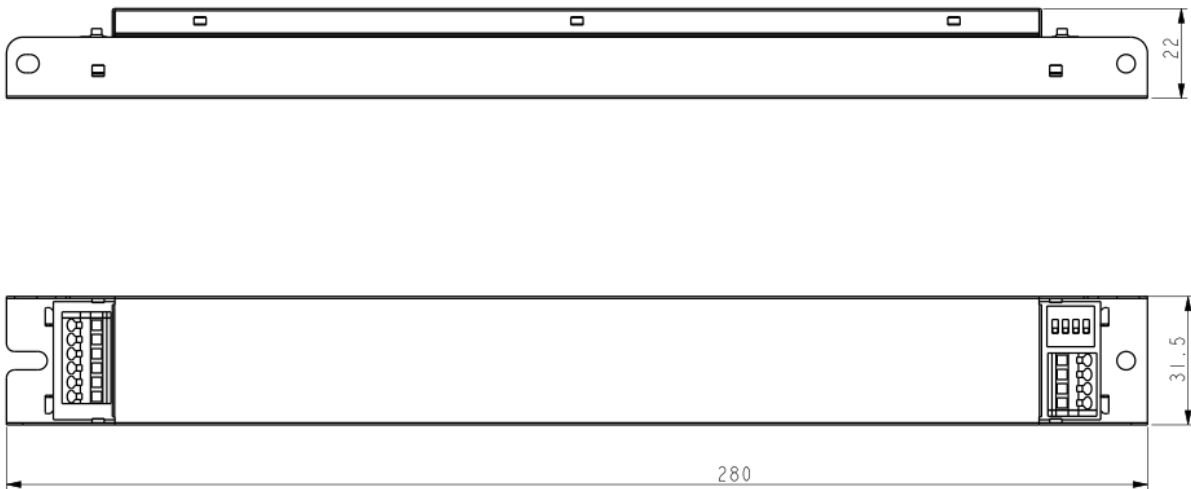

Notes for Figure 5:

1. Drawing dimensions are in millimeters
2. Unless otherwise specified, all linear tolerances are +/-1.0mm

# Wiring Diagram

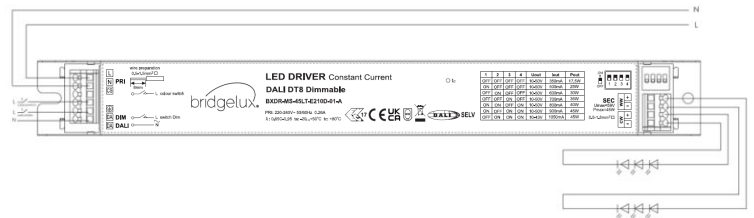
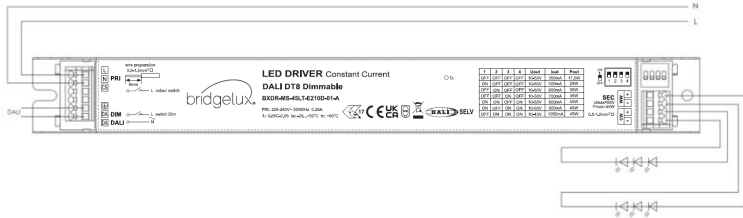

Table 5: **Wiring**

	PRI	
PRI	Cable cross-section	0.5 – 1.5 mm <sup>2</sup> / AWG 20 - 15
	Stripping	8 mm
SEC	Cable cross-section	0.5 – 1.5 mm <sup>2</sup> / AWG 20 - 15
	Stripping	8 mm

Notes for Table 5:

1. Hot plug-in or secondary switching of LEDs is not permitted and may cause a very high current to the LEDs.
2. Unless otherwise specified, all linear tolerances are +/-1.0mm

# DIP-switch operation instructions & operating window

Table 6: **Dip-switch operation instructions & operating window**

Dip-switch setting				U <sub>out</sub>	I <sub>out</sub>
1	2	3	4		
OFF	OFF	OFF	OFF	10-50V	350 mA
ON	OFF	OFF	OFF	10-50V	500 mA
OFF	ON	OFF	OFF	10-50V	600 mA
OFF	OFF	ON	OFF	10-50V	700 mA
ON	ON	OFF	ON	10-50V	800 mA
ON	OFF	ON	ON	10-50V	900 mA
OFF	ON	ON	ON	10-43V	1050 mA

# Environmental and Regulatory Standards

Table 7: Environmental Conditions

Parameter	Specification
Ambient Operating Temperature	-20°C to + 50°C
Max. Case Temperature Tc	+80°C (max)
Max. Case Temperature (In fault condition)	+110°C
Humidity Rating	Maximum 85% Relative Humidity, non condensing
Storage Temperature	-20°C to + 70°C
Main Switching Cycles	> 100,000
Expected Lifetime	50,000 hours (Tc < 80°C)

Table 8: Regulatory Approvals and Compliance

Specification	Reference Standard	Condition
DC or AC supplied electronic controlgear for LED modules	EN 62384	electronic controlgear for use on DC or AC supplies up to 1 000 V (alternating current at 50 Hz or 60 Hz) and with an output frequency which can deviate from the supply frequency
Conducted and Radiated EMI	EN 55015:2019+A1:2020 (CISPR 15:2018)	
Harmonic Current Emissions	EN IEC 61000-3-2:2019	
Voltage Fluctuations & Flicker	IEC 61000-3-3:2013+A1:2019	
ESD (Electrostatic Discharge)	IEC 61547:2009 Section 5.2 Test des.: IEC 61000-4-2	4 kV contact discharge, 8 kV air discharge, level 3
Continuous Radiated Disturbance	IEC 61547:2009 Section 5.3 Test des.: IEC 61000-4-3	3 V/m, 80 - 1000 MHz, 80% modulated at distance of 3 meters
Electrical Fast Transient	IEC 61547:2009 Section 5.5 Test des.: IEC 61000-4-4	± 1 kV on AC power port for 1 minute,
Surge	IEC 61547 Section 5.7 Test des.: IEC 61000-4-5	± 1 kV (differential mode) ± 2 kV (common mode)
Continuous Conducted Disturbance	IEC 61547:2009 Section 5.6 Test des.: IEC 61000-4-6	3V, 0.15-80 MHz, 80% modulated, Level 2
Voltage Dips	IEC 61547 Section 5.8, 5.9 Test des.: IEC 61000-4-11	70% dip during 25 cycles @ 50Hz, 30 cycles @ 60Hz 0% dip during ½ cycles
Touch Current	EN60598-1	lower than 0.7 mA, according to EN 60598-1 annex. G and EN 61347-1 annex A

## Regulatory Standards (continued)

Table 9: Safety Agency Approvals

Specification	Reference Standard	Condition
ENEC / CE / UKCA	EN 61347-1:2015. EN 61347-2-13:2014+A1	ENEC Certification pending

Table 10: DALI-2 DT8 Standards

Specification	Reference Standard	Condition
System Components (Part 101)	EN62386-101	
Control Gear (Part 102)	EN62386-102	
LED Module (Part 207)	EN62386-207	
Color Control (Part 209)	EN62386-209	

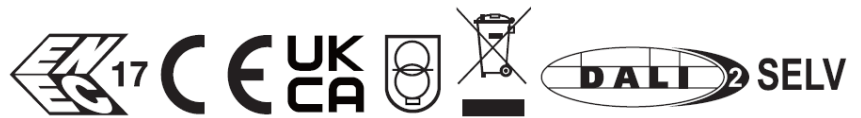

## Packaging

Table 11: Packaging Box Configuration

Parameters	Specification
Driver quantity	100 pcs (10 pcs per inner box)
Outer dimensions	350 X 300 X 300 mm
Weight	26.0 kg



# Design Resources

## Application Notes

Please contact your Bridgelux sales representative for assistance on obtaining application support when designing with the Bridgelux Vesta-D Dual Channel Driver. For a list of available resources, visit [www.bridgelux.com](http://www.bridgelux.com).

# Precautions

## CAUTION: PRODUCT HANDLING

Handle the Vesta-D Dual Channel Driver with care to prevent any damage from mechanical shock. It is recommended to handle this driver in a static-free environment. Do not open or disassemble the product. To maintain product warranty, the installer is responsible for ensuring that the driver's operating conditions do not exceed the maximum conditions stated within this data sheet.

## CAUTION: PRODUCT INSTALLATION

Incorrect installation of the Vesta-D Dual Channel Driver can cause irreparable damage to the driver, connected LEDs. Pay attention when connecting the LED load and observe the correct polarity of the output terminals as specified in this data sheet and on the driver label.

## CAUTION: ELECTRIC SHOCK

Be aware of the possibility of an electric shock hazard which can result in serious injury or death. Disconnect power before servicing or installing this device.

# Disclaimers

## MINOR PRODUCT CHANGE POLICY

The rigorous qualification testing on products offered by Bridgelux provides performance assurance. Slight cosmetic changes that do not affect form, fit, or function may occur as Bridgelux continues product optimization.

## About Bridgelux: Bridging Light and Life™

At Bridgelux, we help companies, industries and people experience the power and possibility of light. Since 2002, we've designed LED solutions that are high performing, energy efficient, cost effective and easy to integrate. Our focus is on light's impact on human behavior, delivering products that create better environments, experiences and returns—both experiential and financial. And our patented technology drives new platforms for commercial and industrial luminaires.

For more information about the company, please visit

[bridgelux.com](http://bridgelux.com)

[twitter.com/Bridgelux](https://twitter.com/Bridgelux)

[facebook.com/Bridgelux](https://facebook.com/Bridgelux)

[youtube.com/user/Bridgelux](https://youtube.com/user/Bridgelux)

[linkedin.com/company/bridgelux](https://linkedin.com/company/bridgelux)

WeChat ID: BridgeluxInChina



46410 Fremont Blvd

Fremont, CA 94538 USA

Tel (925) 583-8400

[www.bridgelux.com](http://www.bridgelux.com)