



Bridgelux® Pallas-D Single Channel 75W (DALI-2) Linear Driver

Product Data Sheet DS479

Product Feature Map

Bridgelux Pallas-D (DALI) Single Channel 75W Driver provides dynamic constant current output for LED modules and arrays. This Driver interoperates with DALI-2 standard lighting systems and protocols and allows for simple integration of Bridgelux's and all major brands White Arrays and Linear modules. Please visit www.bridgelux.com for more information.

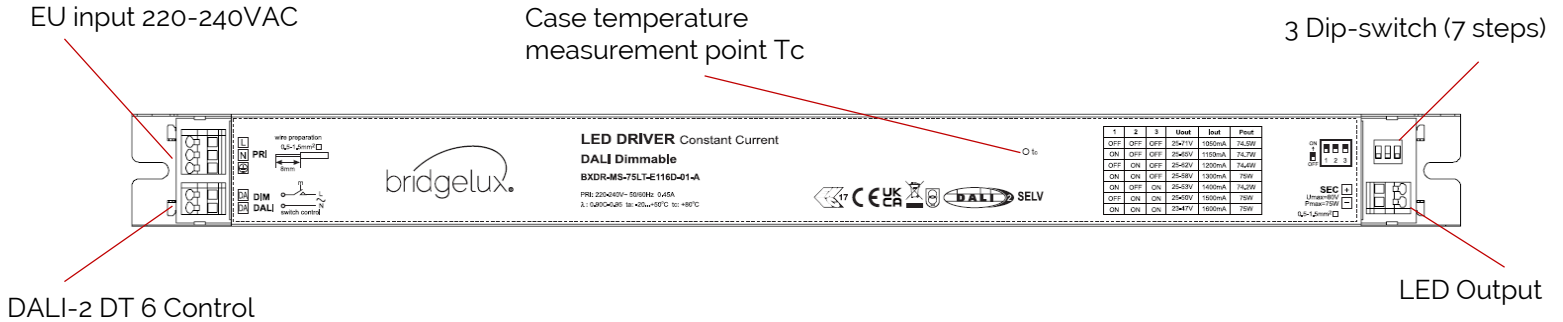

Product Nomenclature

The part number designation for Bridgelux Pallas-D (DALI) Single Channel 75W Driver is explained as follows:

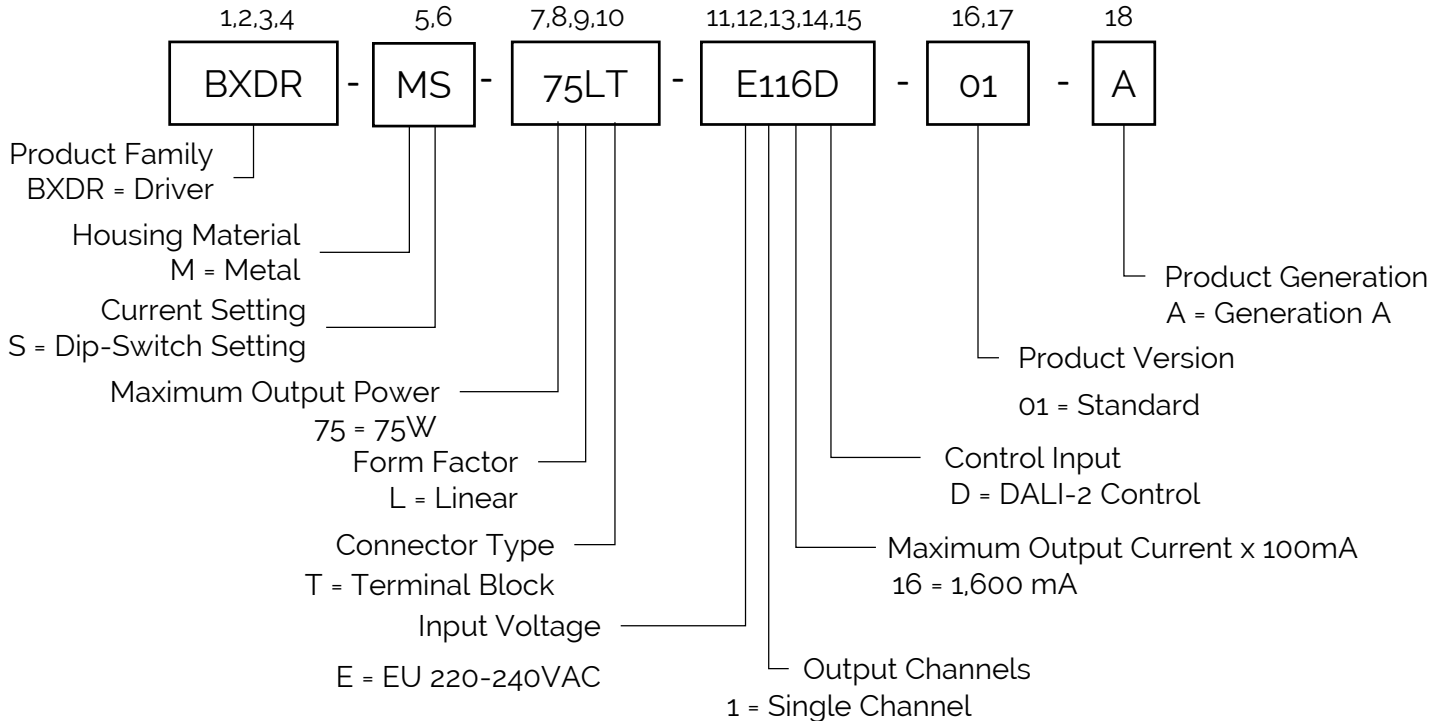

Table 1: Product Selection Guide

Part Number	Configuration
BXDR-MS-75LT-E116D-01-A	Linear

Electrical Characteristics

Table 2: Input Electrical Characteristics

Parameter	Unit	Specification
Nominal voltage	V	220 – 240
Nominal frequency	Hz	50 / 60
AC voltage range	V	198 – 264
DC voltage range	V	176 - 370
Nominal current	A	0.45
THD (Full load)	-	≤ 15
Power factor (Full load)	%	≥ 0.95
Efficiency (Full load)	%	89
NO load	W	≤ 0.5
Protection class	-	II
Inrush current(Cold start)	A pk	< 65 (th = 100 μs)
Max. units per circuit breaker	-	B10:23 B16:37 C10:46 C16:74

Table 3: Output Electrical Characteristics

Parameter	Unit	Specification						
Nominal voltage range	V	25-71V	25-65V	25-62V	25-58V	25-53V	25-50V	23-47V
Maximum voltage(Open Circuit)	Vdc	≤ 80						
Nominal current	mA	1050mA	1150mA	1200mA	1300mA	1400mA	1500mA	1600mA
Current accuracy	%	+/- 5						
Current ripple LF < 200Hz	%	≤ 3						
Pst LM	-	≤ 1						
SVM	-	≤ 0.4						
Maximum power	W	75						
Galvanic isolation: SELV	-	Output voltage of SELV controlgear not exceed limits in 10.4 of IEC61347-1 during the test of 15.1 and 15.2 <i>IEC61347-1 10.4: "Controlgear providing SELV may have accessible conductive parts in the SELV circuit; if : the rated output voltage exceed 60V ripple free d.c., the touch current does not exceed 0,7 mA (peak).</i>						

Electrical Characteristics

Figure 1: Power Factor vs. Load

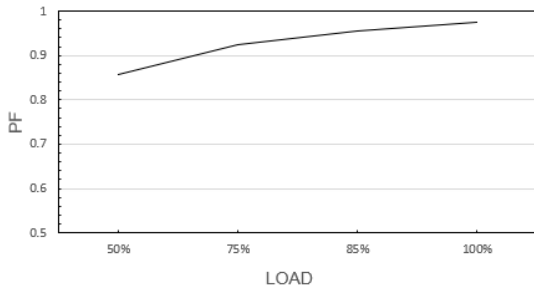

Figure 2: Total Harmonic Distortion vs. Load

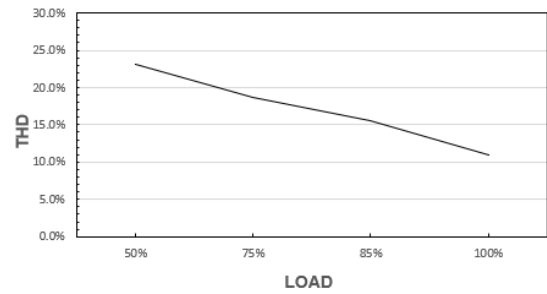

Figure 3: Efficiency vs. Load

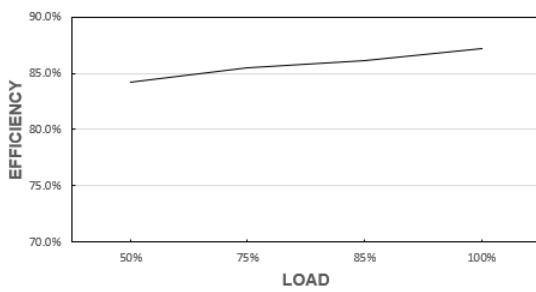
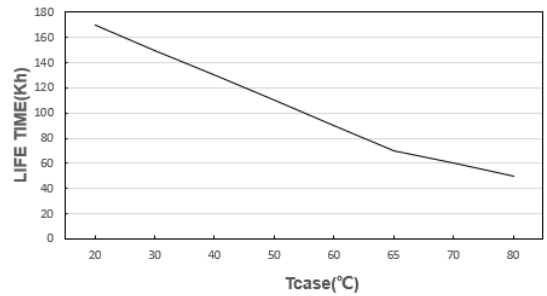

Figure 4: Expected Life Time



Mechanical Characteristics

Table 4: Product Selection Guide

Characteristics	Specification
Dimensions	360.0 mm (L) x 31.0 mm (W) x 21.5 mm (H)
Enclosure Materials	Steel Metal
Weight	280 g
Ingress Protection	IP20

Figure 5: Mechanical Drawing

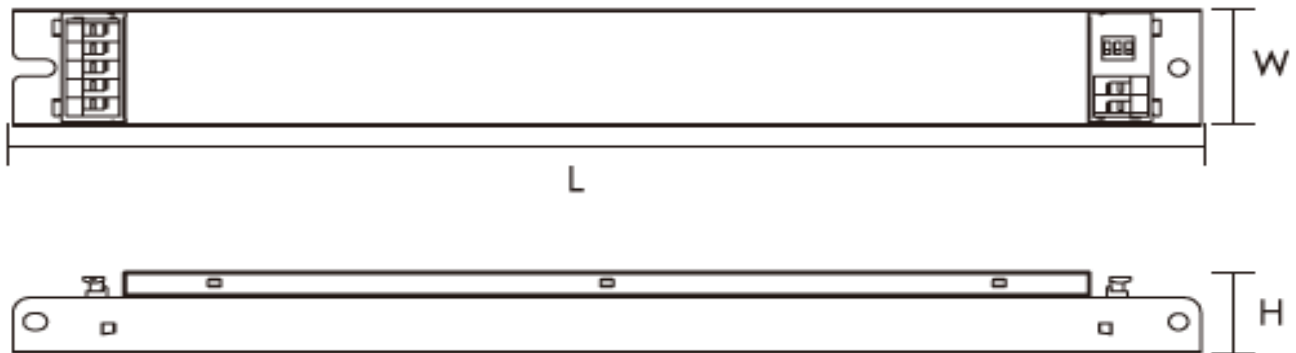

Notes for Figure 5:

1. Drawing dimensions are in millimeters
2. Unless otherwise specified, all linear tolerances are +/-1.0mm

Wiring Diagram

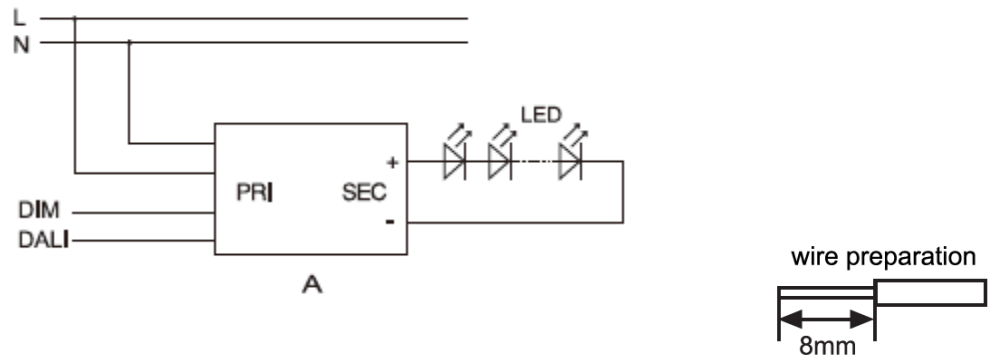

Table 5: Wiring

PRI		
PRI	Cable cross-section	0.5 - 1.5 mm ² / AWG 20 - 15
	Stripping	8 mm
SEC	Cable cross-section	0.5 - 1.5 mm ² / AWG 20 - 15
	Stripping	8 mm

Notes for Table 5:

- Hot plug-in or secondary switching of LEDs is not permitted and may cause a very high current to the LEDs.
- Unless otherwise specified, all linear tolerances are +/-1.0mm

DIP-switch operation instructions & operating window

Table 6: Dip-switch operation instructions & operating window

Dip-switch setting			U _{out}	I _{out}
1	2	3		
OFF	OFF	OFF	25-71V	1050 mA
ON	OFF	OFF	25-65V	1150mA
OFF	ON	OFF	25-62V	1200 mA
ON	ON	OFF	25-58V	1300 mA
ON	OFF	ON	25-53V	1400 mA
OFF	ON	ON	25-50V	1500 mA
ON	ON	ON	23-47V	1600 mA

Environmental and Regulatory Standards

Table 7: Environmental Conditions

Parameter	Specification
Ambient Operating Temperature	-20°C to + 50°C
Max. Case Temperature Tc	+80°C (max)
Max. Case Temperature (In fault condition)	+110°C
Humidity Rating	Maximum 85% Relative Humidity, non condensing
Storage Temperature	-20°C to + 70°C
Expected Lifetime	50,000 hours (Tc < 80°C)

Table 8: Regulatory Approvals and Compliance

Specification	Reference Standard	Condition
DC or AC supplied electronic controlgear for LED modules	EN 62384	electronic controlgear for use on DC or AC supplies up to 1 000 V (alternating current at 50 Hz or 60 Hz) and with an output frequency which can deviate from the supply frequency
Conducted and Radiated EMI	EN 55015:2019+A1:2020 (CISPR 15:2018)	
Harmonic Current Emissions	EN IEC 61000-3-2:2019	
Voltage Fluctuations & Flicker	IEC 61000-3-3:2013+A1:2019	
ESD (Electrostatic Discharge)	IEC 61547:2009 Section 5.2 Test des.: IEC 61000-4-2	4 kV contact discharge, 8 kV air discharge, level 3
Continuous Radiated Disturbance	IEC 61547:2009 Section 5.3 Test des.: IEC 61000-4-3	3 V/m, 80 - 1000 MHz, 80% modulated at distance of 3 meters
Electrical Fast Transient	IEC 61547:2009 Section 5.5 Test des.: IEC 61000-4-4	± 1 kV on AC power port for 1 minute,
Surge	IEC 61547 Section 5.7 Test des.: IEC 61000-4-5	± 1 kV (differential mode) ± 2 kV (common mode)
Continuous Conducted Disturbance	IEC 61547:2009 Section 5.6 Test des.: IEC 61000-4-6	3V, 0.15-80 MHz, 80% modulated, Level 2
Voltage Dips	IEC 61547 Section 5.8, 5.9 Test des.: IEC 61000-4-11	70% dip during 25 cycles @ 50Hz, 30 cycles @ 60Hz 0% dip during ½ cycles
Touch Current	EN60598-1	lower than 0.7 mA, according to EN 60598-1 annex. G and EN 61347-1 annex A

Regulatory Standards (continued)

Table 9: Safety Agency Approvals

Specification	Reference Standard	Condition
ENEC / CE / UKCA	EN 61347-1:2015. EN 61347-2-13:2014+A1	ENEC Certification pending

Table 10: DALI-2 DT6 Standards

Specification	Reference Standard	Condition
System Components (Part 101)	EN62386-101	
Control Gear (Part 102)	EN62386-102	
LED Module (Part 207)	EN62386-207	

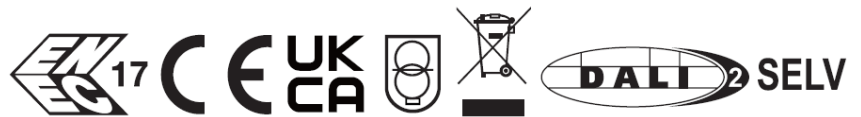

Packaging

Table 11: Packaging Box Configuration

Parameters	Specification
Driver quantity	50 pcs (10 pcs per inner box)
Outer dimensions	380 X 180 X 300 mm
Weight	15.5 kg

Design Resources

Application Notes

Please contact your Bridgelux sales representative for assistance on obtaining application support when designing with the Bridgelux Pallas-D Single Channel Driver. For a list of available resources, visit www.bridgelux.com.

Precautions

CAUTION: PRODUCT HANDLING

Handle the Pallas-D Single Channel Driver with care to prevent any damage from mechanical shock. It is recommended to handle this driver in a static-free environment. Do not open or disassemble the product. To maintain product warranty, the installer is responsible for ensuring that the driver's operating conditions do not exceed the maximum conditions stated within this data sheet.

CAUTION: PRODUCT INSTALLATION

Incorrect installation of the Pallas-D Single Channel Driver can cause irreparable damage to the driver, connected LEDs. Pay attention when connecting the LED load and observe the correct polarity of the output terminals as specified in this data sheet and on the driver label.

CAUTION: ELECTRIC SHOCK

Be aware of the possibility of an electric shock hazard which can result in serious injury or death. Disconnect power before servicing or installing this device.

Disclaimers

MINOR PRODUCT CHANGE POLICY

The rigorous qualification testing on products offered by Bridgelux provides performance assurance. Slight cosmetic changes that do not affect form, fit, or function may occur as Bridgelux continues product optimization.

About Bridgelux: Bridging Light and Life™

At Bridgelux, we help companies, industries and people experience the power and possibility of light. Since 2002, we've designed LED solutions that are high performing, energy efficient, cost effective and easy to integrate. Our focus is on light's impact on human behavior, delivering products that create better environments, experiences and returns—both experiential and financial. And our patented technology drives new platforms for commercial and industrial luminaires.

For more information about the company, please visit

bridgelux.com

twitter.com/Bridgelux

facebook.com/Bridgelux

youtube.com/user/Bridgelux

linkedin.com/company/bridgelux

WeChat ID: BridgeluxInChina



46410 Fremont Blvd

Fremont, CA 94538 USA

Tel (925) 583-8400

www.bridgelux.com