

Bridgelux® Vesta® Series RGBW 10mm Array With CSP

Product Data Sheet DS581



Product Feature Map

Bridgelux arrays are fully engineered devices that provide consistent thermal and optical performance on an engineered mechanical platform. The arrays incorporate several features to simplify design integration and assembly. Please visit www.bridgelux.com for more information on the Vesta Series family of products.

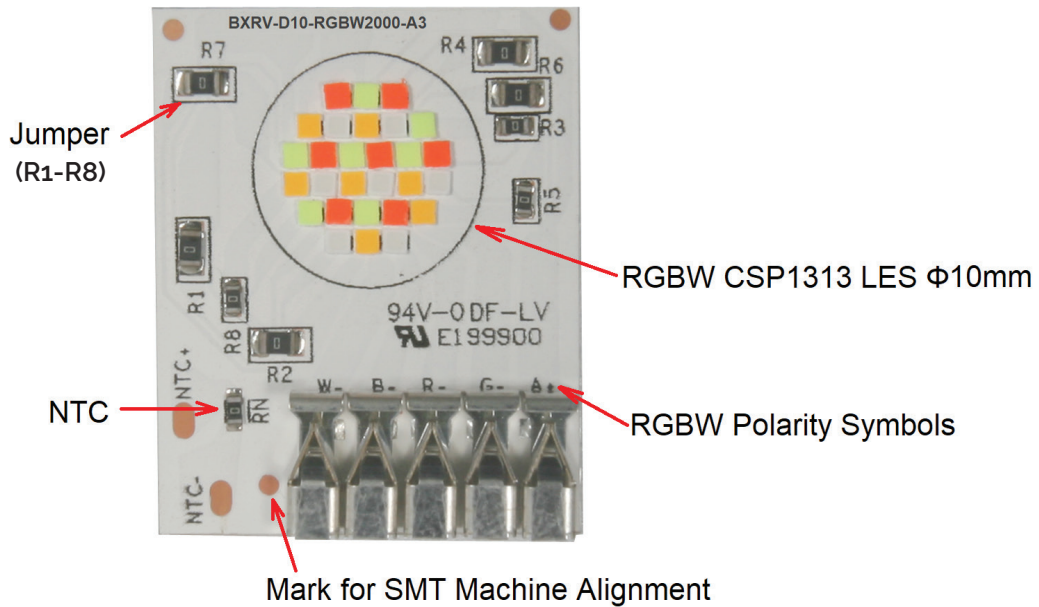

Product Nomenclature

The part number designation for Bridgelux Vesta Series arrays is explained as follows:

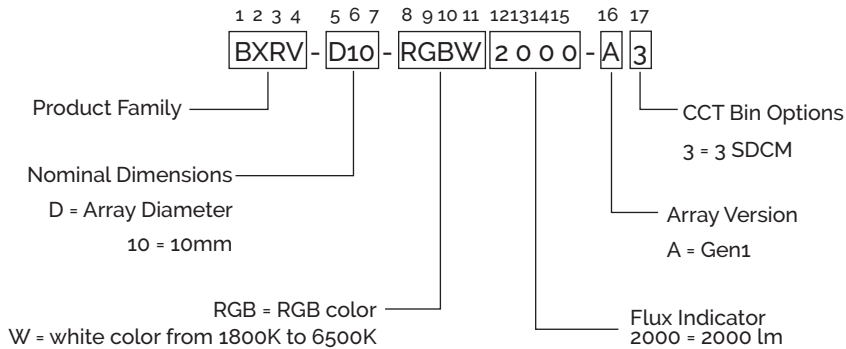

Product Selection Guide

The following product configurations are available:

Table 1: Selection Guide, White Pulsed Measurement Data ($T_j=T_c=25^\circ\text{C}$)

Part Number	Nominal CCT ¹ (K)	CRI ²	Nominal Drive Current Per Channel (mA)				Forward Voltage ³ (V)				Typical Pulsed Flux ^{3,4,5} (lm)	Typical Power (W)	Typical Efficacy (lm/W)
			White	Red	Green	Blue	White	Red	Green	Blue			
BXRV-D10-RGBW2000-A3	1800	86	200	300	0	0	19.4	19.8	0.0	0.0	764	9.8	78
	2200	90	225	300	24	0	19.0	19.5	18.0	0.0	934	10.6	88
	2700	90	421	248	70	16	20.1	19.7	18.8	17.8	1542	14.9	103
	3000	90	449	185	93	28	20.2	19.4	19.0	18.0	1661	14.9	111
	3500	90	451	133	127	44	20.2	19.2	19.2	18.2	1770	14.9	119
	4000	90	426	104	164	61	20.1	19.0	19.4	18.3	1844	14.9	124
	5000	90	403	52	203	97	20.0	18.9	19.6	18.5	1905	14.8	129
	5700	90	371	48	223	113	20.0	18.7	19.6	18.6	1909	14.8	129
	6500	90	339	44	240	132	19.9	18.6	19.7	18.7	1899	14.8	129
BXRV-D10-RGBW2000-A3	1800	86	200	300	0	0	19.4	19.8	0.0	0.0	764	9.8	78
	2200	93	225	300	26	0	19.5	19.9	18.4	0.0	941	10.8	87
	2700	95	338	287	72	13	19.9	19.9	18.8	17.8	1393	14.0	99
	3000	95	350	244	95	24	19.9	19.7	19.0	18.0	1499	14.0	107
	3500	95	310	236	130	38	19.8	19.7	19.2	18.0	1548	14.0	111
	4000	95	307	187	163	53	19.8	19.5	19.4	18.2	1642	13.8	119
	5000	95	273	134	218	85	19.7	19.2	19.6	18.5	1733	13.8	126
	5700	95	278	101	227	104	19.7	19.0	19.7	18.6	1758	13.8	128
	6500	95	256	91	242	121	19.6	19.0	19.7	18.7	1751	13.8	127

Table 2: Selection Guide, RGBW Pulsed Measurement Data at 350mA ($T_j=T_c=25^\circ\text{C}$)

Part Number	Color	Nominal Drive Current (mA)	Forward Voltage ³ (V)			Typical Pulsed Flux ^{3,4,5} (lm)	Typical Power (W)	Typical Efficacy (lm/W)
			Min	Typical	Max			
BXRV-D10-RGBW2000-A3	Red	300	19.0	20.4	21.8	238	6.1	39
	Green	350	19.6	21	22.4	1330	7.3	181
	Blue	350	19.6	21	22.4	140	7.4	19
	White ⁷	350	19.6	21	22.4	1050	7.3	143

Notes for Tables 1 & 2:

- Nominal CCT as defined by ANSI C78.377-2011.
- Listed CRIs are minimum values and include test tolerance.
- Products tested under pulsed condition (10ms pulse width) at nominal drive current where T_j (junction temperature) = T_c (case temperature) = 25°C .
- Typical performance values are provided as a reference only and are not a guarantee of performance.
- Bridgelux maintains a $\pm 7.5\%$ tolerance on flux measurements
- Typical stabilized DC performance values are provided as reference only and are not a guarantee of performance.
- CSP for White color is targeted at CCT of 2500K

Product Selection Guide

Table 3: Selection Guide, White Stabilized DC Performance ($T_c = 85^\circ\text{C}$)⁶

Part Number	Nominal CCT ¹ (K)	CRI ²	Nominal Drive Current Per Channel (mA)				Forward Voltage ⁴ (V)				Typical DC Flux ^{3, 5, 6} (lm)	Typical Power (W)	Typical Efficacy (lm/W)
			White	Red	Green	Blue	White	Red	Green	Blue			
BXRV-D10-RGBW2000-A3	1800	86	200	300	0	0	19.0	19.4	0.0	0.0	652	9.6	68
	2200	90	225	300	24	0	19.0	19.4	17.9	0.0	794	10.5	75
	2700	90	421	248	70	16	19.6	19.2	18.4	17.4	1304	14.6	89
	3000	90	449	185	93	28	19.7	19.0	18.5	17.6	1403	14.6	96
	3500	90	451	133	127	44	19.7	18.8	18.7	17.8	1486	14.5	102
	4000	90	426	104	164	61	19.6	18.6	18.9	17.9	1534	14.5	106
	5000	90	403	52	203	97	19.6	18.3	19.0	18.1	1562	14.5	108
	5700	90	371	48	223	113	19.5	18.2	19.1	18.2	1548	14.4	107
	6500	90	339	44	240	132	19.4	18.2	19.2	18.3	1522	14.4	106
BXRV-D10-RGBW2000-A3	1800	86	200	300	0	0	19.0	19.4	0.0	0.0	652	9.6	68
	2200	93	225	300	26	0	19.0	19.4	18.0	0.0	803	10.6	76
	2700	95	338	287	72	13	19.4	19.4	18.4	17.3	1178	13.7	86
	3000	95	350	244	95	24	19.4	19.2	18.5	17.5	1268	13.7	93
	3500	95	310	236	130	38	19.3	19.2	18.7	17.7	1300	13.6	95
	4000	95	307	187	163	53	19.3	19.0	18.9	17.8	1369	13.5	101
	5000	95	273	134	218	85	19.2	18.8	19.1	18.0	1403	13.4	104
	5700	95	278	101	227	104	19.2	18.6	19.1	18.1	1418	13.4	105
	6500	95	256	91	242	121	19.1	18.6	19.2	18.2	1396	13.4	104

Table 4: Selection Guide, RGBW Stabilized DC Performance at 350mA ($T_c = 85^\circ\text{C}$)⁶

Part Number	Color	Nominal Drive Current (mA)	Forward Voltage ⁴ (V)			Typical DC Flux ^{3, 5, 6} (lm)	Typical Power (W)	Typical Efficacy (lm/W)
			Min	Typical	Max			
BXRV-D10-RGBW2000-A3	Red	300	18.6	20.0	22.1	181	6.0	30
	Green	350	18.9	20.3	22.4	1176	7.1	166
	Blue	350	18.9	20.3	22.4	142	7.1	20
	White ⁷	350	18.9	20.3	22.4	952	7.1	134

Notes for Tables 3 & 4:

- Nominal CCT as defined by ANSI C78.377-2011.
- Listed CRIs are minimum values and include test tolerance.
- Typical stabilized DC performance values are provided as reference only and are not a guarantee of performance.
- Typical performance values are provided as a reference only and are not a guarantee of performance.
- Bridgelux maintains a $\pm 7.5\%$ tolerance on flux measurements
- Typical performance is estimated based on operation under DC (direct current) with LED array mounted onto a heat sink with thermal interface material and the case temperature maintained at 85°C . Based on Bridgelux test setup, values may vary depending on the thermal design of the luminaire and/or the exposed environment to which the product is subjected.
- CSP for White color is targeted at CCT of 2500K

Performance at Commonly Used Drive Currents

Vesta Series CSP RGBW arrays are tested to the specifications shown using the nominal drive currents in Tables 1 & 2. Vesta Series CSP RGBW arrays may also be driven at other drive currents dependent on specific application design requirements. The relative luminous flux vs. current characteristics are shown in Figures 3, 4 & 5. The performance at commonly used drive currents is summarized in Tables 5 & 6.

Table 5: White Performance at Commonly Used Drive Currents ($T_j=T_c=25^{\circ}\text{C}$)

Nominal CCT (K)	CRI	Nominal Drive Current Per Channel (mA)				Forward Voltage (V)				Typical Pulsed Flux ² (lm)	Typical Power (W)	Typical Efficacy (lm/W)
		White	Red	Green	Blue	White	Red	Green	Blue			
1800	86	120	180	0	0	19.0	19.4	0.0	0.0	501	5.8	87
		160	240	0	0	19.2	19.6	0.0	0.0	641	7.8	83
		200	300	0	0	19.4	19.8	0.0	0.0	764	9.8	78
2700	90	253	149	42	10	19.6	19.2	18.6	17.8	1022	8.8	117
		337	198	56	13	19.8	19.4	18.7	17.9	1297	11.8	110
		421	248	70	16	20.1	19.7	18.8	17.8	1542	14.9	103
		491	289	82	19	20.2	19.7	18.8	18.0	1713	17.5	98
4000	90	256	62	98	37	19.6	18.7	18.9	18.2	1205	8.7	139
		341	83	131	49	19.8	18.9	19.0	18.4	1541	11.7	132
		426	104	164	61	20.1	19.0	19.4	18.3	1844	14.9	124
		497	121	191	71	20.2	19.0	19.4	18.5	2067	17.4	119
6500	90	203	26	144	79	19.3	18.3	19.3	18.6	1226	8.6	142
		271	35	192	106	19.5	18.4	19.5	18.8	1573	11.7	135
		339	44	240	132	19.9	18.6	19.7	18.7	1899	14.8	129
		396	51	280	154	20.0	18.6	19.8	19.5	2139	17.4	123
1800	86	120	180	0	0	19.0	19.4	0.0	0.0	501	5.8	87
		160	240	0	0	19.2	19.6	0.0	0.0	641	7.8	83
		200	300	0	0	19.4	19.8	0.0	0.0	764	9.8	78
2700	95	203	172	43	8	19.4	19.3	18.6	17.7	914	8.2	111
		270	230	58	10	19.6	19.6	18.7	17.8	1166	11.1	105
		338	287	72	13	19.9	19.9	18.8	17.8	1393	14.0	99
4000	95	184	112	98	32	19.3	19.03	19.0	18.2	1053	8.1	130
		246	150	130	42	19.5	19.2	19.2	18.3	1359	10.9	124
		307	187	163	53	19.8	19.5	19.4	18.2	1642	13.8	119
		358	218	190	62	19.9	19.5	19.4	18.5	1857	16.2	115
6500	95	154	55	145	73	19.1	18.6	19.2	18.5	1116	8.1	138
		205	73	194	97	19.3	18.8	19.5	18.7	1445	10.9	133
		256	91	242	121	19.6	19.0	19.7	18.7	1751	13.8	127
		299	106	282	141	19.6	19.0	19.8	19.0	1981	16.1	123

Notes for Table 5:

1. Alternate drive currents in Table 5 are provided for reference only and are not a guarantee of performance.
2. Bridgelux maintains a $\pm 7.5\%$ tolerance on flux measurements.

Performance at Commonly Used Drive Currents

Table 6: RGB Performance at Commonly Used Drive Currents

Color	Drive Current Per Channel (mA)	Forward Voltage (V) T _c = 25°C	Typical Power (W) T _c = 25°C	Typical Pulsed Flux ² (lm) T _c = 25°C	Typical Pulsed Flux ² (lm) T _c = 85°C	Typical Efficacy (lm/W) T _c = 85°C
Red	50	18.7	0.9	49	43	53
	150	19.5	2.9	134	116	46
	200	19.8	4.0	171	147	43
	250	20.1	5.0	206	177	41
	300	20.4	6.1	238	203	39
Green	50	18.6	0.9	217	187	233
	150	19.4	2.9	624	531	214
	200	19.7	3.9	812	689	206
	250	20.1	5.0	990	833	197
	300	20.3	6.1	1166	990	191
	350	21.0	7.4	1330	1118	181
Blue	50	18.5	0.9	25	26	27
	150	19.4	2.9	68	71	23
	250	20.2	5.0	106	108	21
	350	20.8	7.3	140	142	19
	450	21.5	9.7	171	173	18
	500	21.7	10.9	186	187	17
White	50	18.7	0.9	173	160	185
	150	19.5	2.9	494	451	169
	250	20.2	5.0	785	712	156
	350	21.0	7.4	1050	949	143
	450	21.3	9.6	1303	1167	136
	500	21.6	10.8	1417	1258	131

Notes for Table 6:

1. Alternate drive currents in Table 6 are provided for reference only and are not a guarantee of performance.
2. Bridgelux maintains a ± 7.5% tolerance on flux measurements.
3. Please refer to Table 7 for maximum current ratings for each color.

Absolute Maximum Ratings

Table 7: Maximum Ratings

Parameter	Maximum Rating			
Storage Temperature	-40°C to +85°C			
Operating Case Temperature (T _c)	85°C			
Soldering Temperature	350°C or lower for a maximum of 5 seconds			
	White	Red	Green	Blue
Maximum Drive Current Per Channel or Per Color	500mA	300mA	350mA	500mA
Maximum Peak Pulsed Forward Current ¹	700mA	500mA	500mA	700mA

Note for Table 7:

1. Bridgelux recommends a maximum duty cycle of 10% and pulse width of 20ms when operating LED arrays at the maximum peak pulsed current specified. Maximum peak pulsed currents indicate values where the LED array can be driven without catastrophic failures.

Table 8: Dimming White with CRI90 Ratio

CCT \ Color	1800K	2200K	2700K	3000K	3500K	4000K	5000K	5700K	6500K
W	40.0%	41.0%	55.8%	59.5%	59.7%	56.4%	53.4%	49.1%	44.9%
R	60.0%	54.6%	32.8%	24.5%	17.6%	13.8%	6.9%	6.4%	5.8%
G	0.0%	4.4%	9.3%	12.3%	16.8%	21.7%	26.9%	29.5%	31.8%
B	0.0%	0.0%	2.1%	3.7%	5.8%	8.1%	12.8%	15.0%	17.5%

Table 9: Dimming White with CRI95 Ratio

CCT \ Color	1800K	2200K	2700K	3000K	3500K	4000K	5000K	5700K	6500K
W	40.0%	40.8%	47.6%	49.1%	43.4%	43.2%	38.5%	39.2%	36.1%
R	60.0%	54.4%	40.4%	34.2%	33.1%	26.3%	18.9%	14.2%	12.8%
G	0.0%	4.7%	10.1%	13.3%	18.2%	23.0%	30.7%	32.0%	34.1%
B	0.0%	0.0%	1.8%	3.4%	5.3%	7.5%	12.0%	14.6%	17.0%

Performance Curves

Figure 1: Relative Current Ratio vs. CCT at CRI 90 ($T_c = 85^\circ\text{C}$)

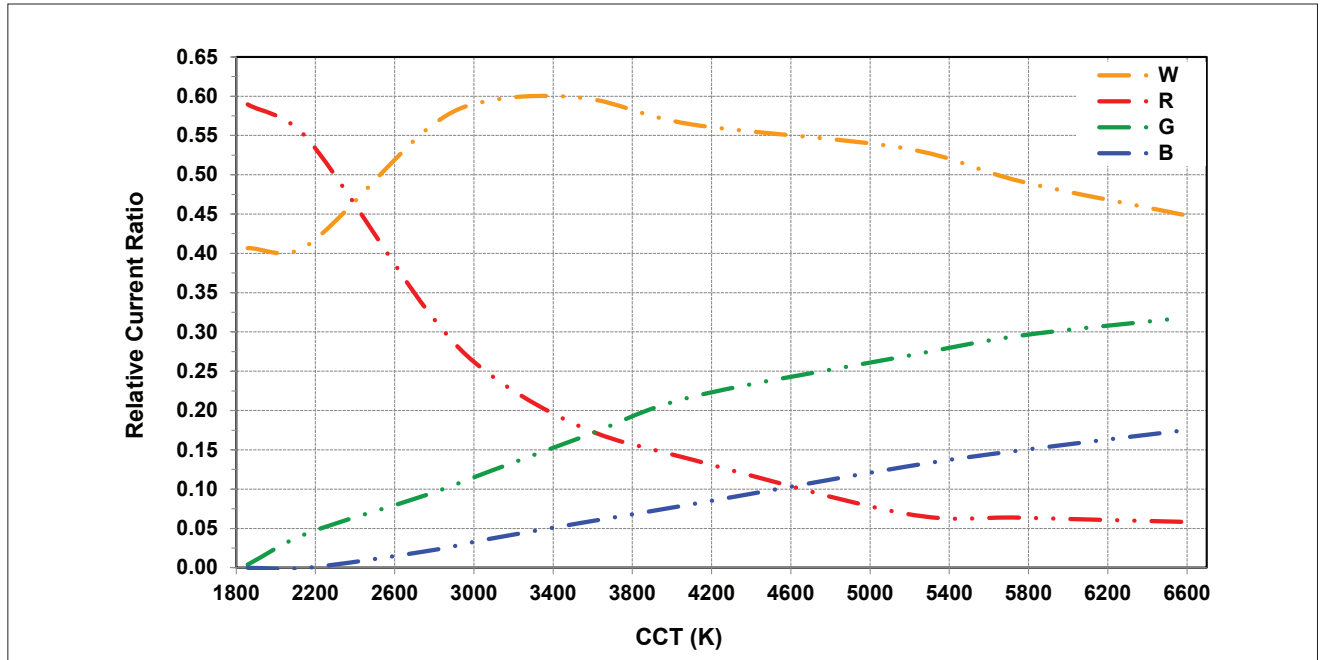
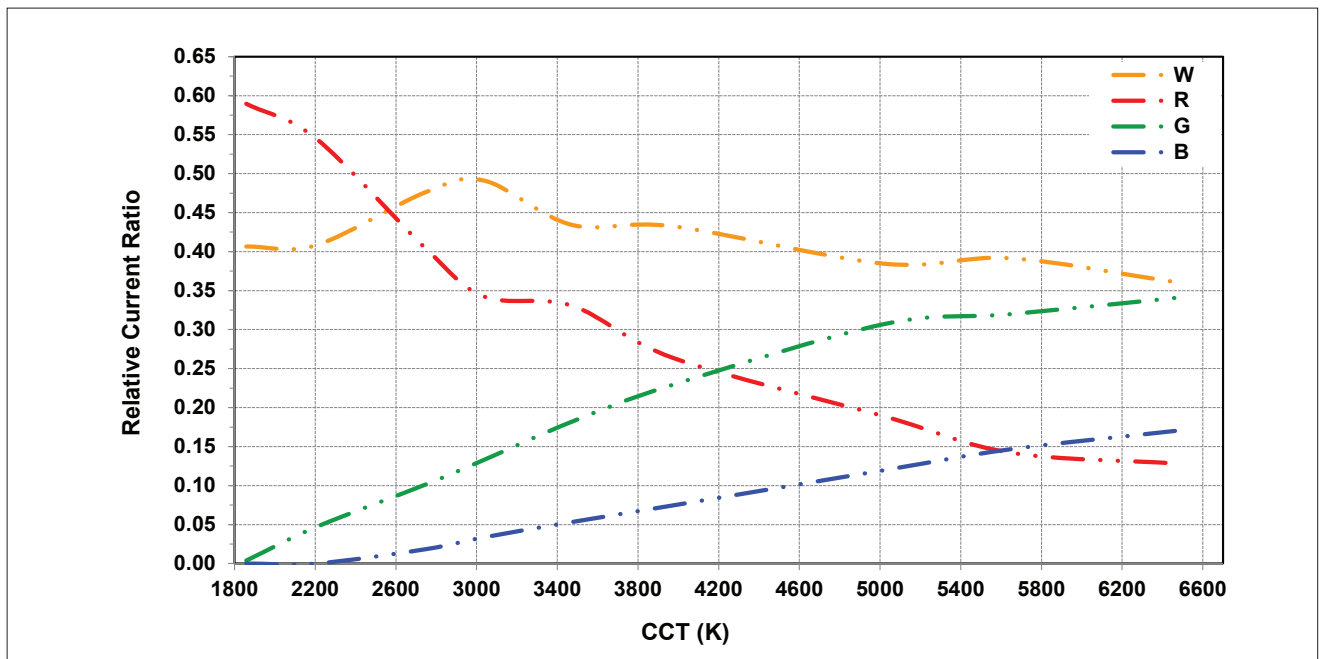

Figure 2: Relative Current Ratio vs. CCT at CRI 95 ($T_c = 85^\circ\text{C}$)



Performance Curves

Figure 3: Typical Relative Luminous Flux (White CCT) vs. Drive Current Per Channel at CRI 90

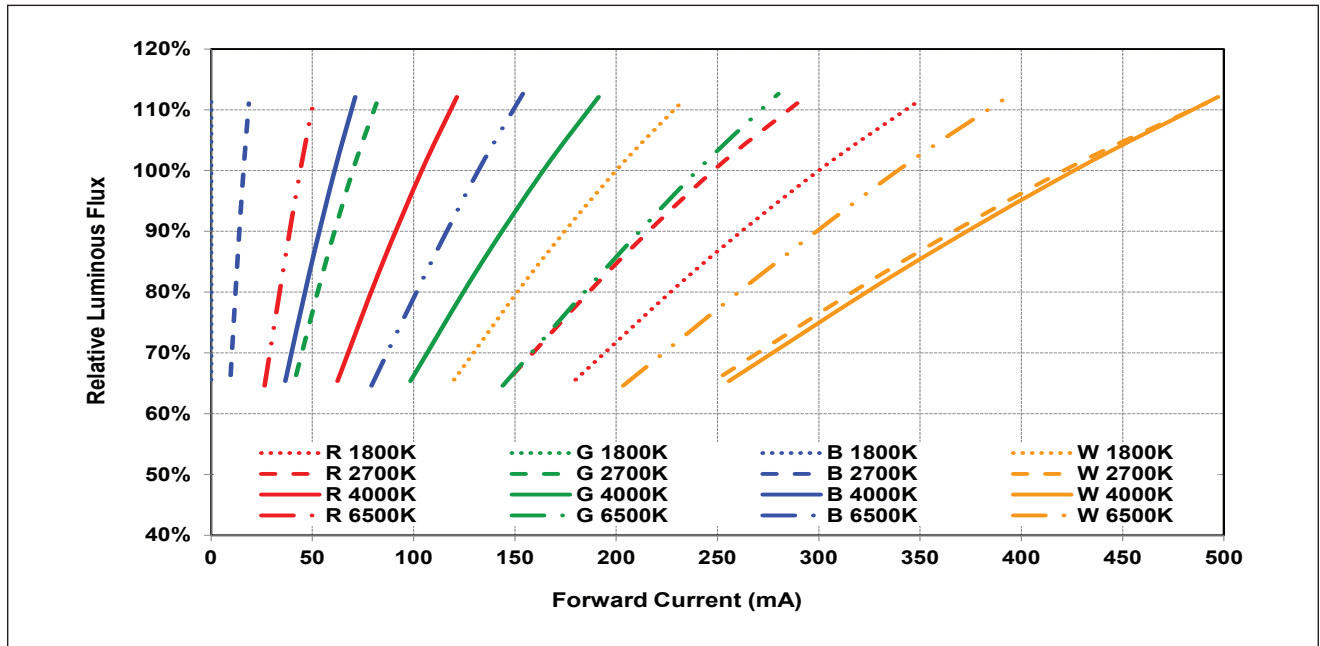
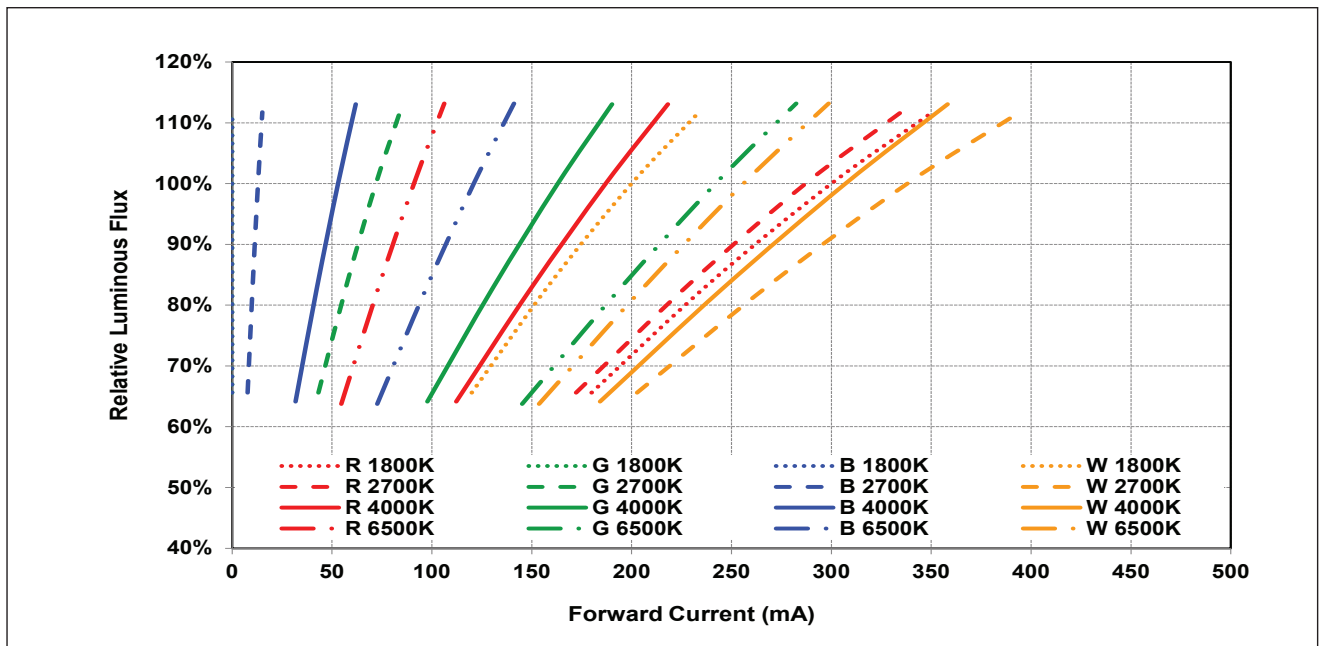

Figure 4: Typical Relative Luminous Flux (White CCT) vs. Drive Current Per Channel at CRI 95



Notes for Figures 3 & 4:

1. Bridgelux does not recommend driving LEDs at low currents. Doing so may produce unpredictable results. Pulse width modulation (PWM) is recommended for dimming effects
2. Please refer to Table 7 for maximum current ratings for each color. The curves extending beyond the maximum current are provided for reference only.

Performance Curves

Figure 5: Typical Relative Luminous Flux (RGBW) vs. Drive Current Per Color ($T_c=25^\circ\text{C}$)

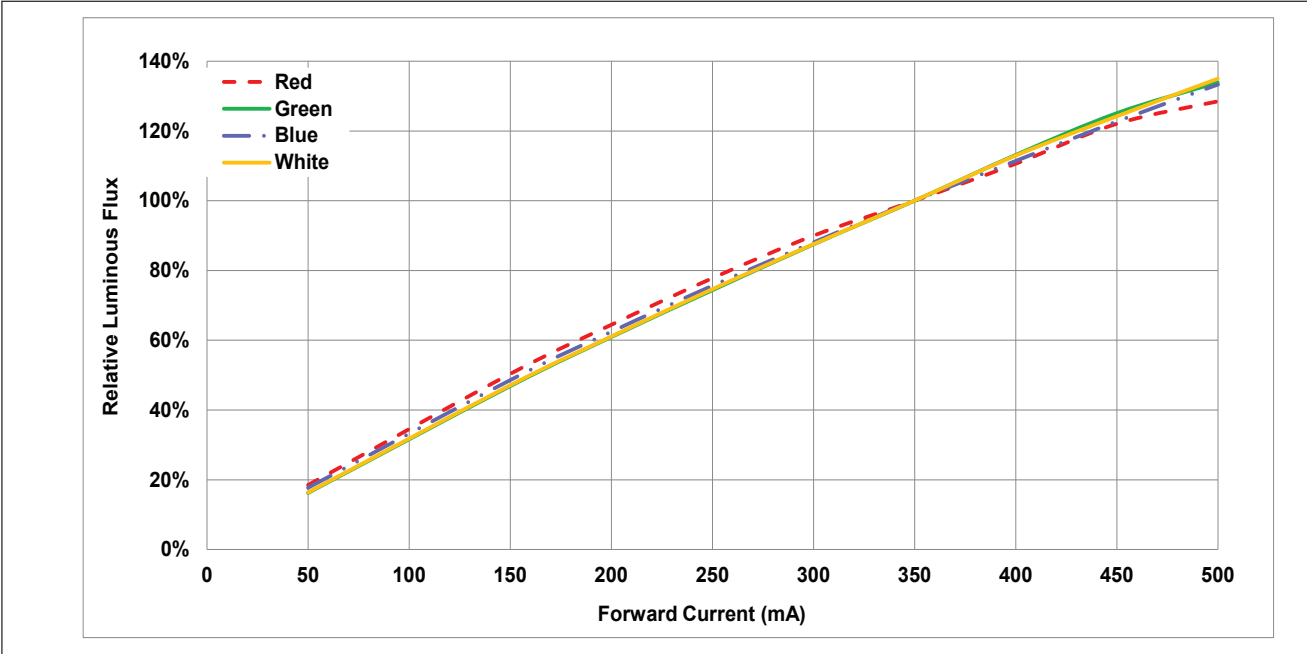

Notes for Figure 5:

1. Bridgelux does not recommend driving LEDs at low currents. Doing so may produce unpredictable results. Pulse width modulation (PWM) is recommended for dimming effects.
2. Please refer to Table 7 for maximum current ratings for each color. The curves extending beyond the maximum current are provided for reference only.

Performance Curves

Figure 6: Typical Relative Luminous Flux (White CCT) vs. Solder Point Temperature at CRI 90

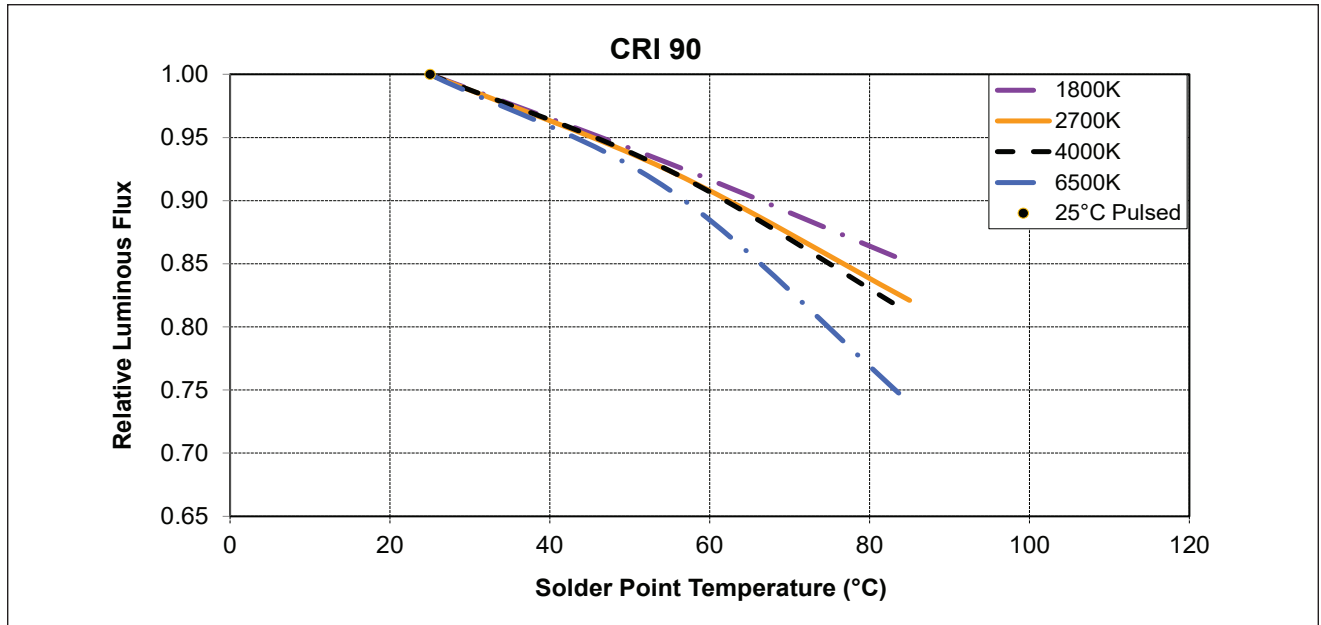
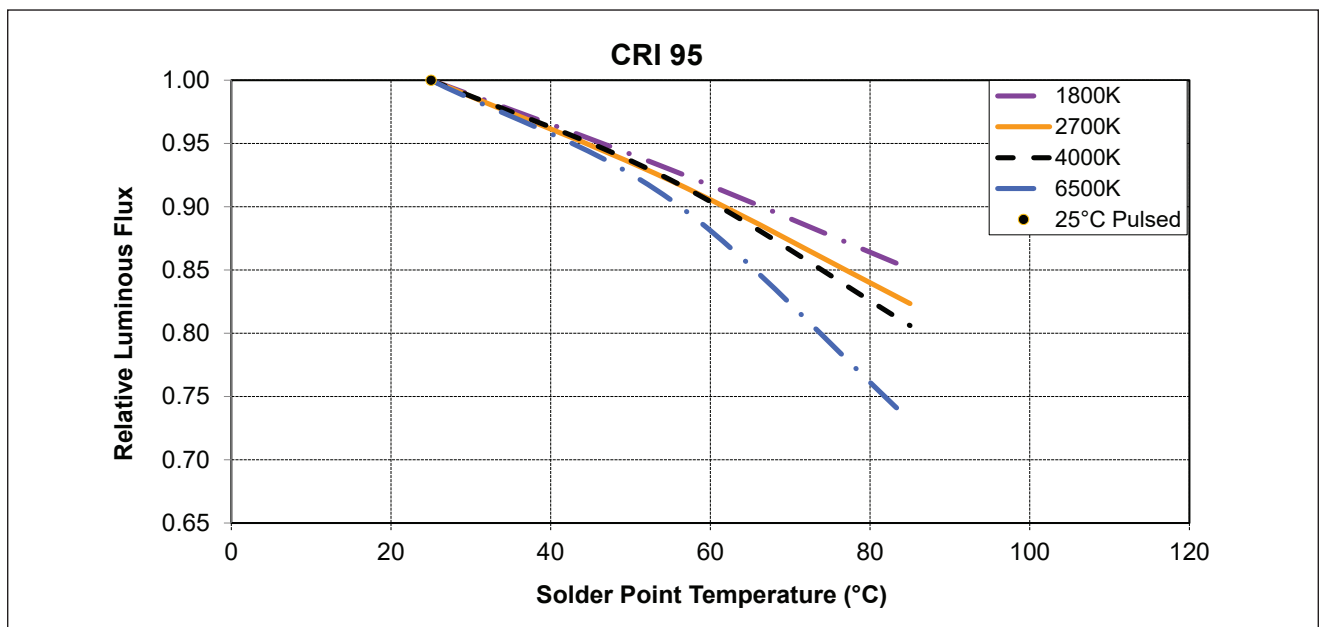
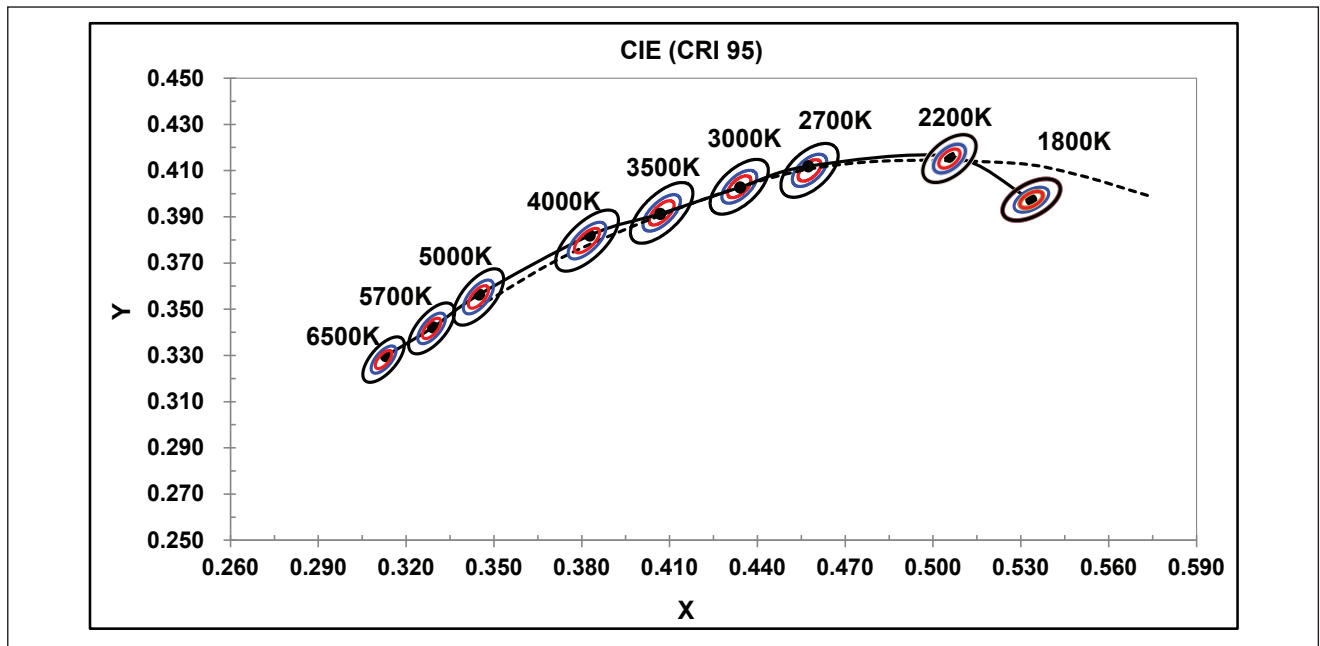
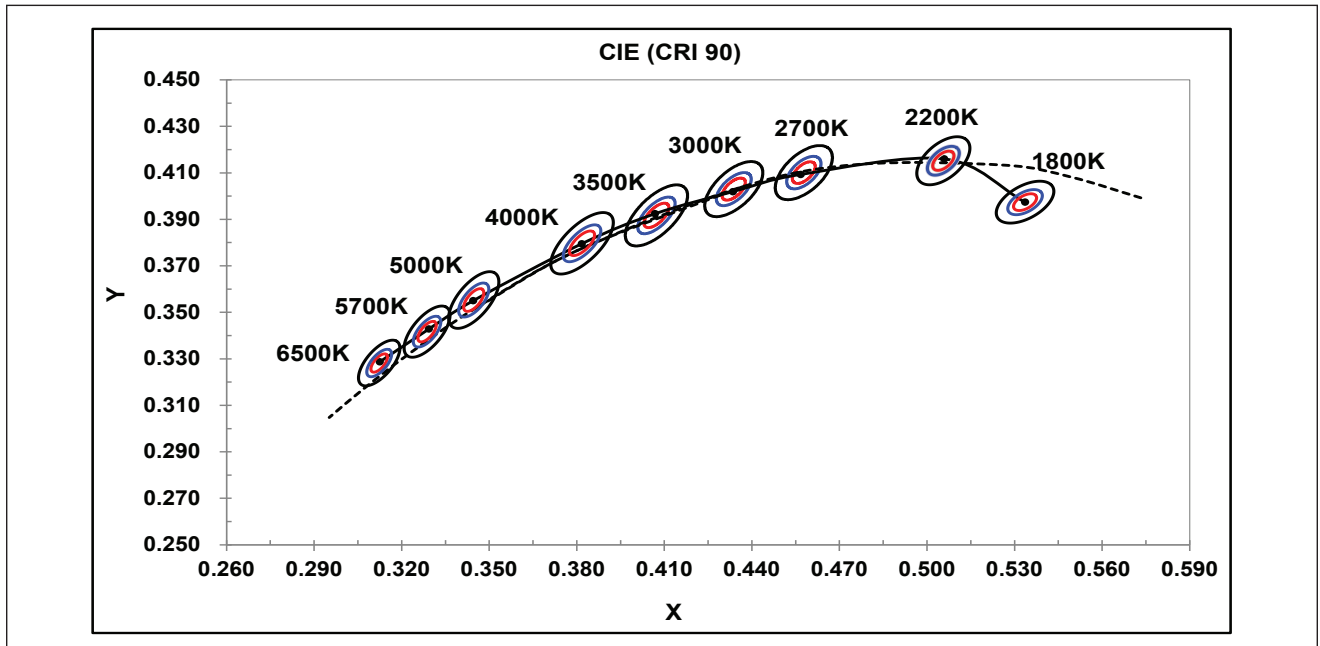

Figure 7: Typical Relative Luminous Flux (White CCT) vs. Solder Point Temperature at CRI 95



Performance Curves

Figure 8: Chromaticity Coordinate Group (Color Targeted at $T_c = 85^\circ\text{C}$)



Performance Curves

Figure 9: Typical Color Spectrum (White CCT, at $T_c = 85^\circ\text{C}$)

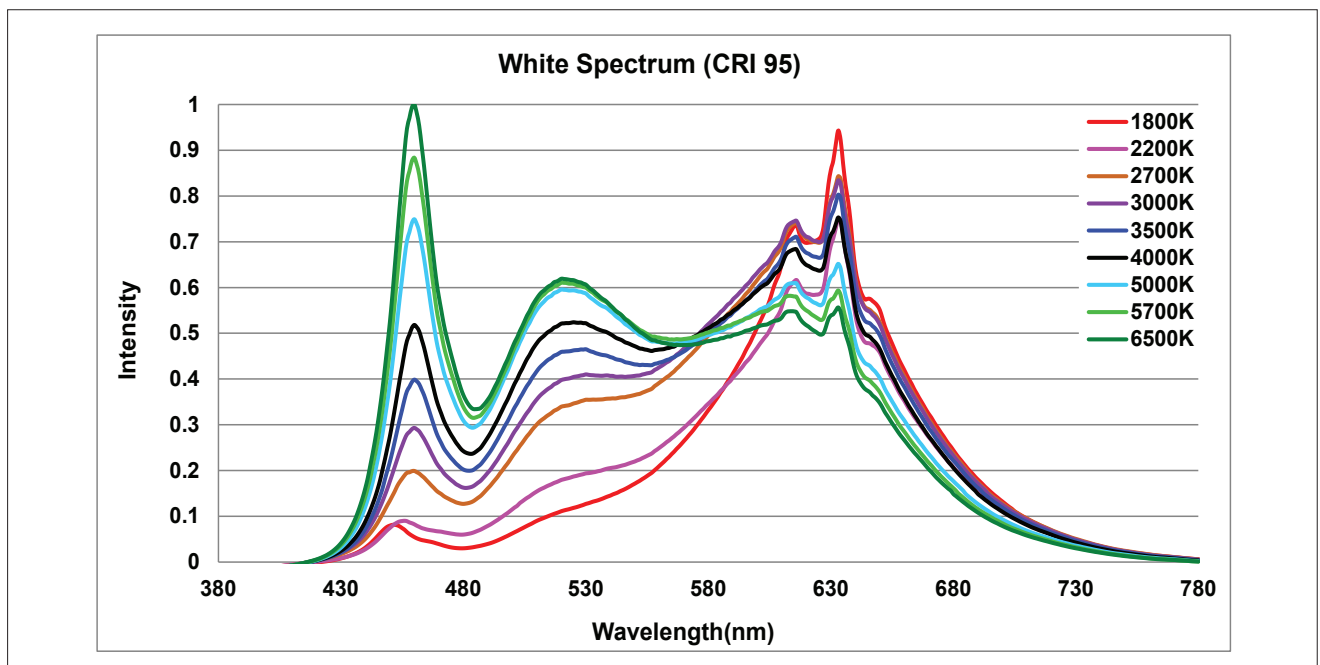
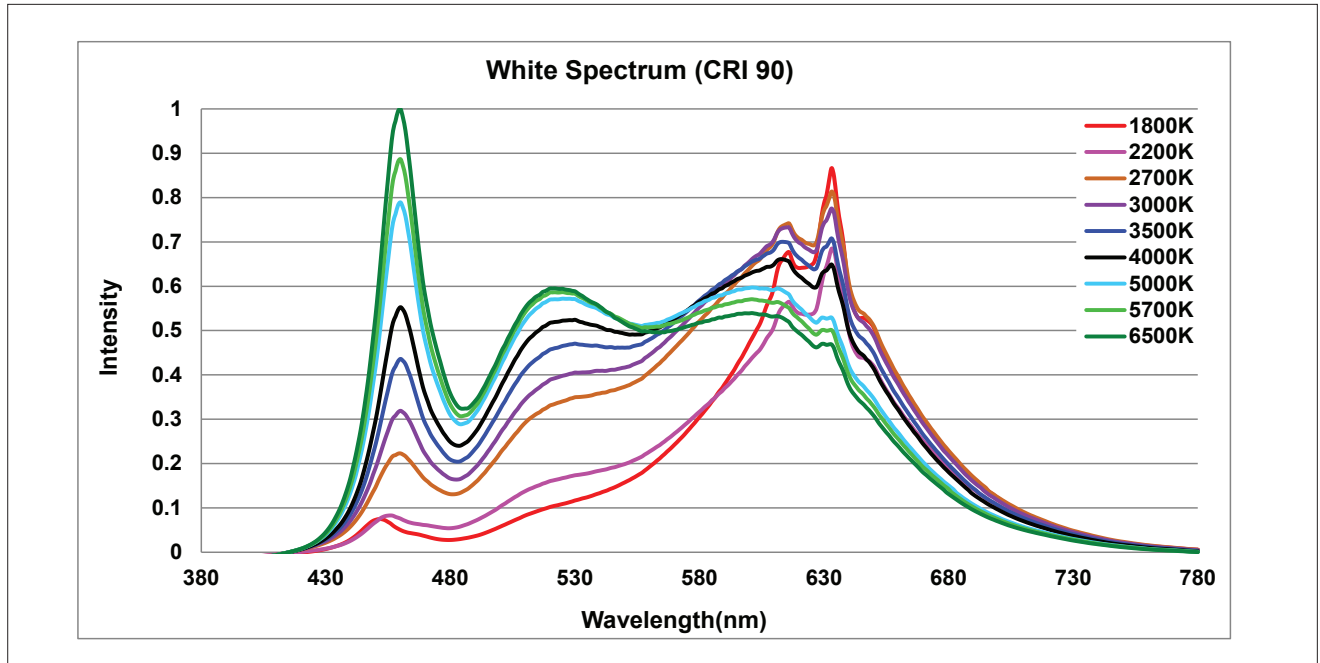

Typical Color Spectrum

Figure 10: Typical Color Spectrum (RGBW)

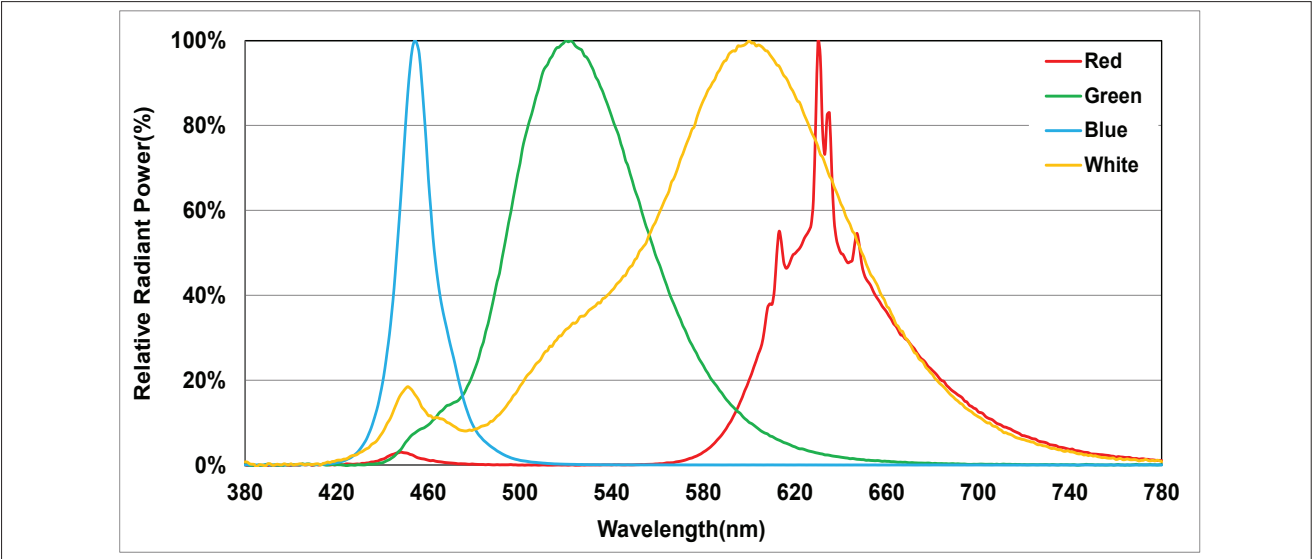

Notes for Figures 9 & 10: Color spectra measured at nominal current for Tc = 85°C.

Product Bin Definitions

Table 10: RGW MacAdam Ellipse Color Bin Definitions

Color	Center Point		Major Axis	Minor Axis	Ellipse Rotation Angle	Color Bin
	X	Y				
R	0.6568	0.3095	0.01854	0.00828	160	1
G	0.2455	0.6000	0.03084	0.00960	75	1
W	0.4870	0.4320	0.00834	0.00408	53.22	3
			0.01390	0.00680	53.22	5 (E/F/G/H)

Table 11: Blue MacAdam Ellipse Color Bin Definitions

	Coordinates			
X	0.1510	0.1241	0.1380	0.1650
Y	0.0227	0.0578	0.0830	0.0460

Notes for Tables 10 & 11:

1. Color binning at $T_c = 85^\circ\text{C}$ unless otherwise specified
2. Bridgelux maintains a tolerance of ± 0.007 on x and y color coordinates.

Figure 11: Chromaticity Coordinate Group (1 Color Bin Structure, Color Targeted at $T_c = 85^\circ\text{C}$)

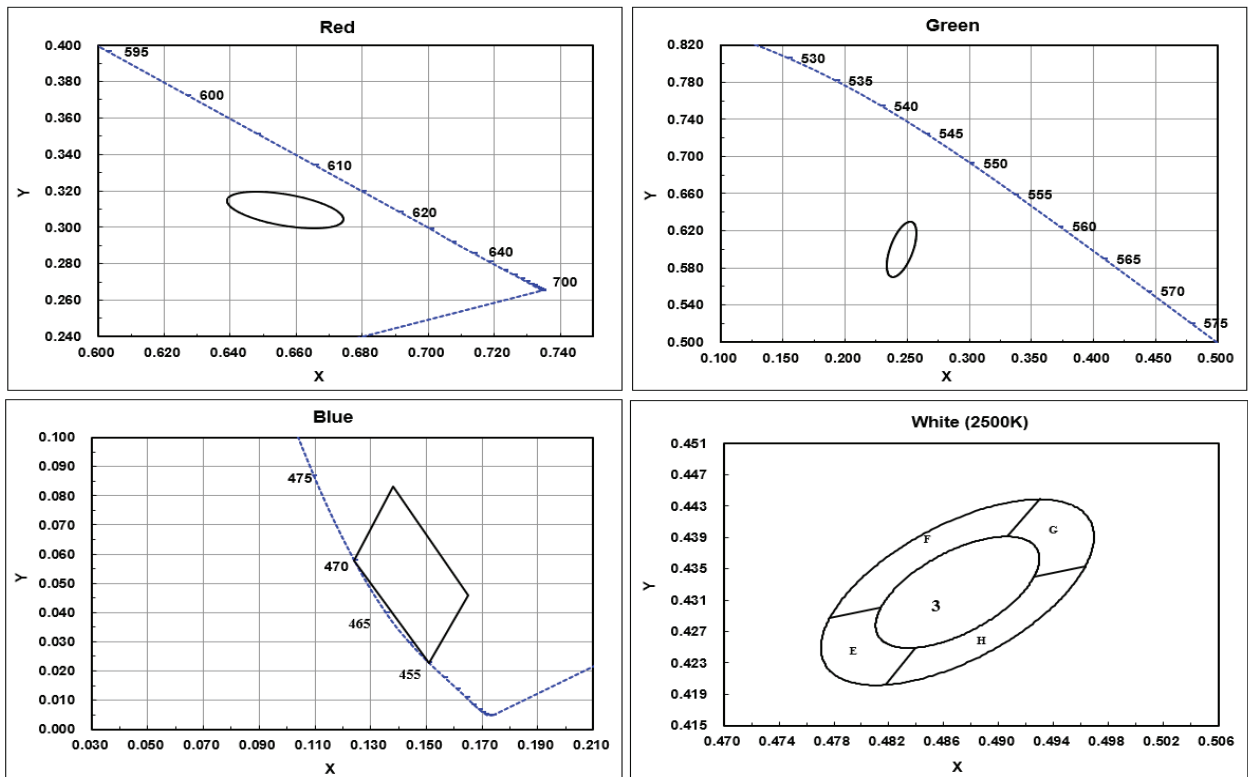

Mechanical Dimensions

Figure 12: Mechanical Drawing Specifications

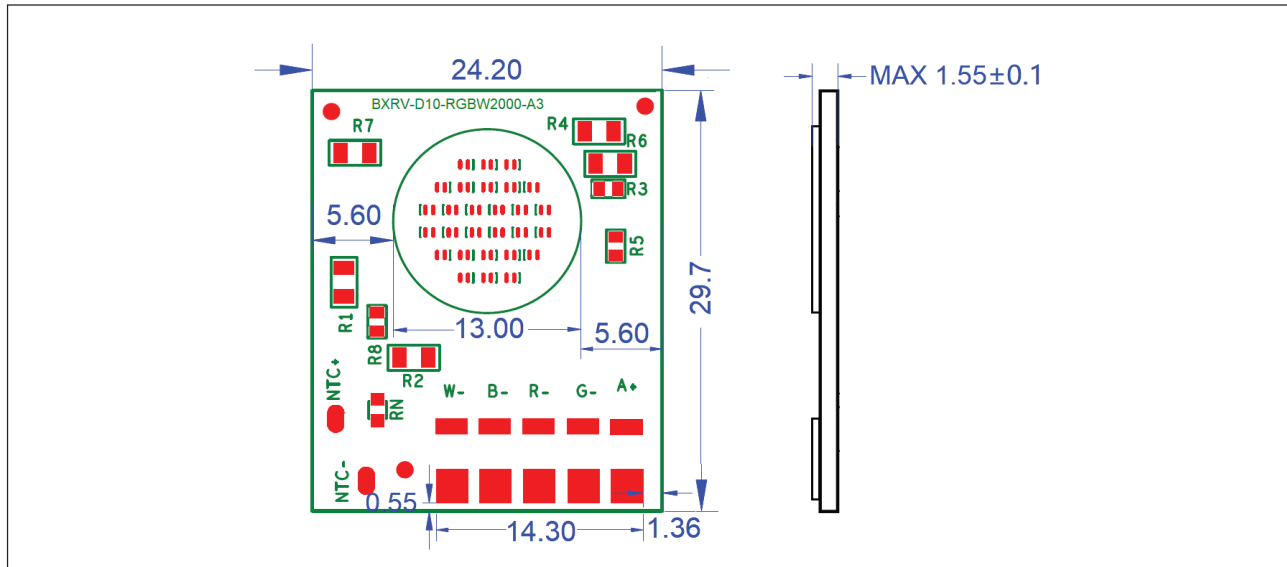

Notes for Figure 12:

1. Solder pads are labeled "+" to denote positive polarity and "-" to denote negative polarity.
2. Drawings are not to scale.
3. Drawing dimensions are in millimeters.
4. Unless otherwise specified, tolerances are $\pm 0.10\text{mm}$.
5. The optical center of the LED array is nominally defined by the mechanical center of the array.

Packaging and Labeling

Figure 13: Vesta Series RGBW 10mm LES Array Packaging and Labeling

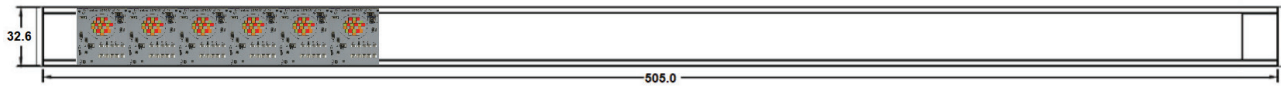

Tube label



Bag



Box

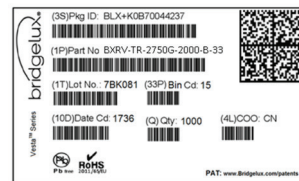

Notes for Figure 13:

1. Each tube holds 20 Vesta Series RGBW 10mm LES arrays.
2. Four tubes are sealed in an anti-static bag. Up to five such bags are placed in a box and shipped. Depending on quantities ordered, a bigger shipping box, containing four boxes will be used to ship products.
3. Each bag and box is to be labeled as shown above.
4. Dimensions for each tube are 505.0 mm (L) x 32.6 mm (W) x 9.5 mm (H). Dimensions for the anti-static bag are 100.0 mm (W) x 625.0 mm (L) x 0.1 mm (T) and that of the inner box are 58.7 mm (L) x 13.3 mm (W) x 7.9 mm (H).

Design Resources

Application Notes

Vesta Series RGBW arrays are intended for use in dry, indoor applications. Bridgelux has developed a comprehensive set of application notes and design resources to assist customers in successfully designing with the Vesta Series product family of LED array products. For a list of resources under development, visit www.bridgelux.com.

Optical Source Models

Optical source models and ray set files are available for all Bridgelux products. For a list of available formats, visit www.bridgelux.com.

3D CAD Models

Three dimensional CAD models depicting the product outline of all Bridgelux Vesta Series LED arrays are available in both IGS and STEP formats. Please contact your Bridgelux sales representative for assistance.

LM80

Please contact your Bridgelux sales representative for more information.

Precautions

CAUTION: CHEMICAL EXPOSURE HAZARD

Exposure to some chemicals commonly used in luminaire manufacturing and assembly can cause damage to the LED array. Please consult Bridgelux Application Note for additional information.

CAUTION: EYE SAFETY

The Bridgelux Vesta series LED array emits visible light, that, under certain circumstances, could be harmful to the eye. Proper safeguards must be used.

CAUTION: RISK OF BURN

Do not touch the Vesta Series LED array during operation. Allow the array to cool for a sufficient period of time before handling. The Vesta Series LED array may reach elevated temperatures such that could burn skin when touched.

CAUTION

CONTACT WITH LIGHT EMITTING SURFACE (LES)

Avoid any contact with the LES. Do not touch the LES of the LED array or apply stress to the LES (yellow phosphor resin area). Contact may cause damage to the LED array.

Optics and reflectors must not be mounted in contact with the LES (yellow phosphor resin area). Optical devices may be mounted on the top surface of the Vesta Series LED array. Use the mechanical features of the LED array housing, edges and/or mounting holes to locate and secure optical devices as needed.

Disclaimers

STANDARD TEST CONDITIONS

Unless otherwise stated, array testing is performed at the nominal drive current.

MINOR PRODUCT CHANGE POLICY

The rigorous qualification testing on products offered by Bridgelux provides performance assurance. Slight cosmetic changes that do not affect form, fit, or function may occur as Bridgelux continues product optimization.

About Bridgelux: Bridging Light and Life™

At Bridgelux, we help companies, industries and people experience the power and possibility of light. Since 2002, we've designed LED solutions that are high performing, energy efficient, cost effective and easy to integrate. Our focus is on light's impact on human behavior, delivering products that create better environments, experiences and returns—both experiential and financial. And our patented technology drives new platforms for commercial and industrial luminaires.

For more information about the company, please visit

bridgelux.com

twitter.com/Bridgelux

facebook.com/Bridgelux

youtube.com/user/Bridgelux

linkedin.com/company/bridgelux

WeChat ID: BridgeluxInChina



46410 Fremont Blvd
Fremont, CA 94538 USA
Tel (925) 583-8400
www.bridgelux.com