

# Bridgelux® Pallas-NS Single Channel 40W (Non-SELV) Linear Driver

Product Data Sheet DS1234

# Product Feature Map

Bridgelux Pallas-NS (Non-SELV) Single Channel 40W Driver provides dynamic constant current output for LED modules and arrays. This driver provides easy-to-adjust Dip-Switches configurable output current and allows for simple integration of Bridgelux's and all major brands White Arrays and Linear modules. Please visit [www.bridgelux.com](http://www.bridgelux.com) for more information.



## Product Nomenclature

The part number designation for Bridgelux Pallas-NS (Non-SELV) Single Channel 40W Driver is explained as follows:

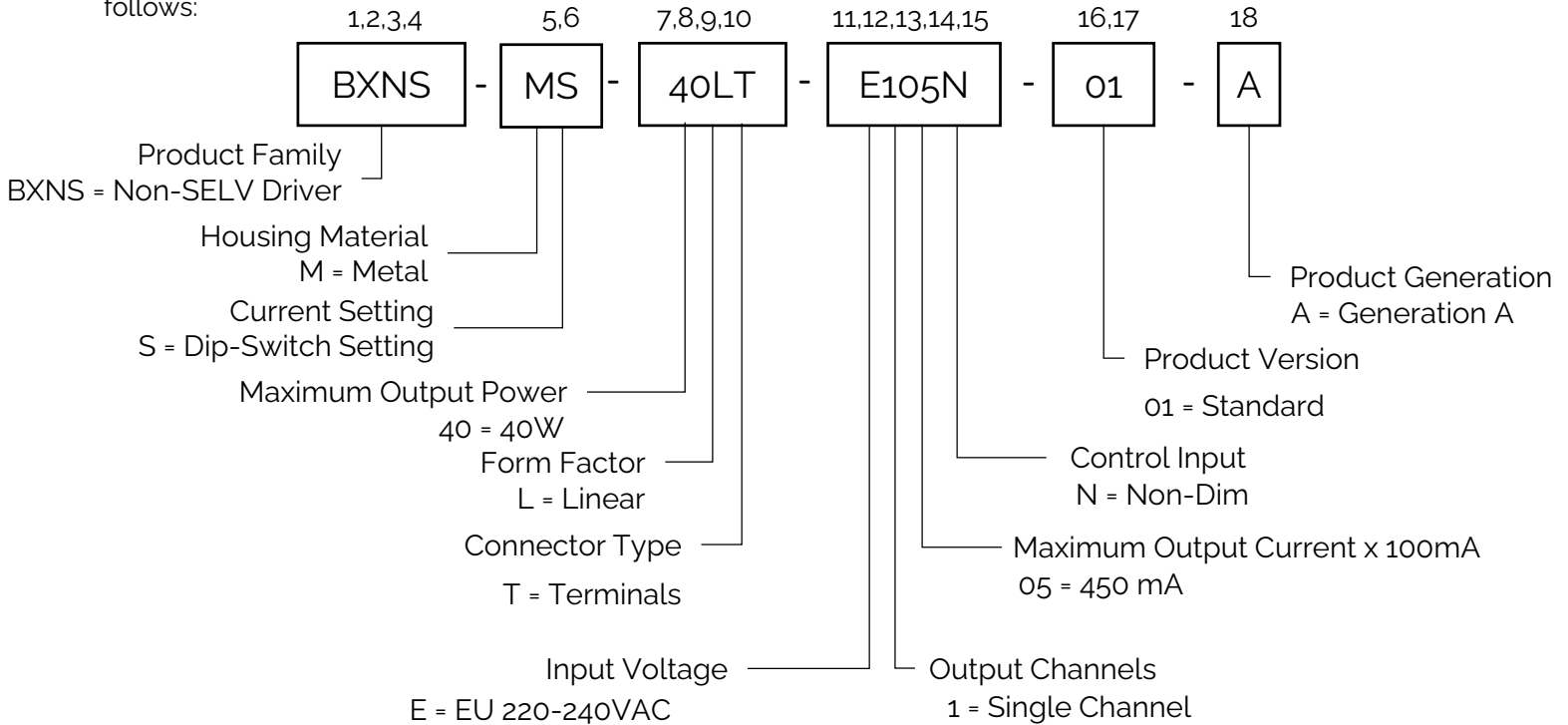

Table 1: Product Selection Guide

Part Number	Configuration
BXNS-MS-40LT-E105N-01-A	Linear Metal with Dip-Switches built-in

# Electrical Characteristics

Table 2: Input Electrical Characteristics

Parameter	Unit	Specification
Nominal voltage	V	220 – 240
Nominal frequency	Hz	50 / 60
AC voltage range	V	176 – 264
DC voltage range	V	176 – 280
Nominal current	A	0.25
Power factor (Full load)		≥ 0.9
THD (Full load)	%	≤ 10
Efficiency (Full load)	%	≥ 90
NO load	W	0.5
Protection class		I
Inrush current(Cold start)	A pk	< 17.6 (th = 162 μs)
Max. units per circuit breaker		B10: 29; B16: 46; B20: 58; C10: 32; C16: 51; C20: 64

Table 3: Output Electrical Characteristics

Parameter	Unit	Specification							
Nominal voltage range	V	40-220V	40-220V	40-200V	40-160V	40-133V	40-114V	40-100V	40-88V
Maximum voltage(Open Circuit)	Vdc	≤ 250							
Nominal current	mA	100	150	200	250	300	350	400	450
Current accuracy	%	+/- 5							
Current ripple LF < 120Hz	%	≤ 5							
Pst LM		≤ 1							
SVM		≤ 0.4							
Maximum power	W	40							
Galvanic isolation		Non-SELV							

# Electrical Characteristics

Figure 1: Typical Operating Window

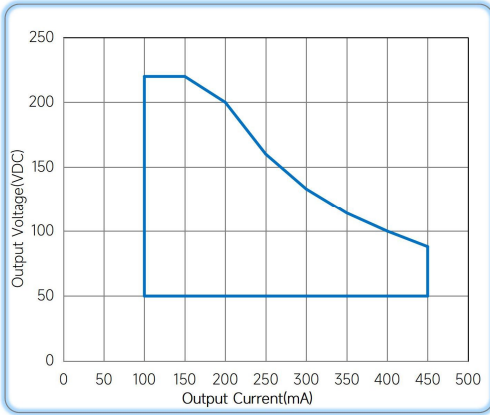

Figure 2: Typical THD vs. Load

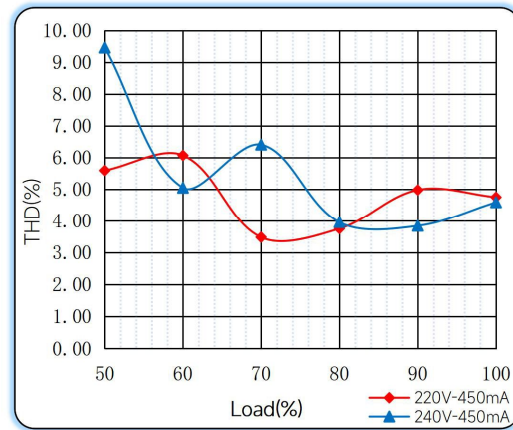

Figure 3: Typical Efficiency vs. Load

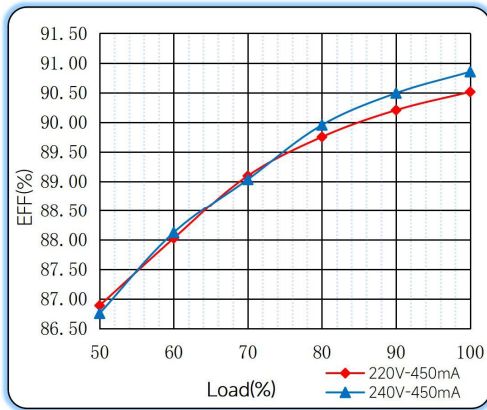

Figure 4: Typical Power Factor vs. Load

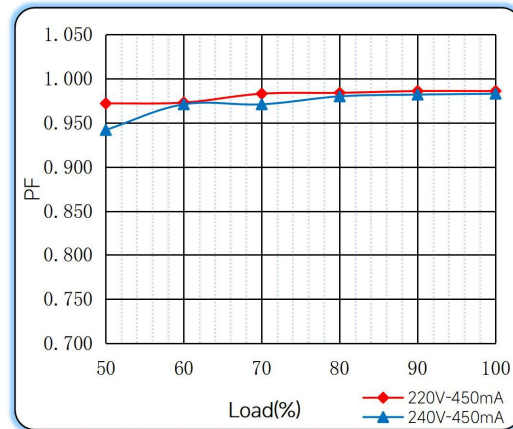
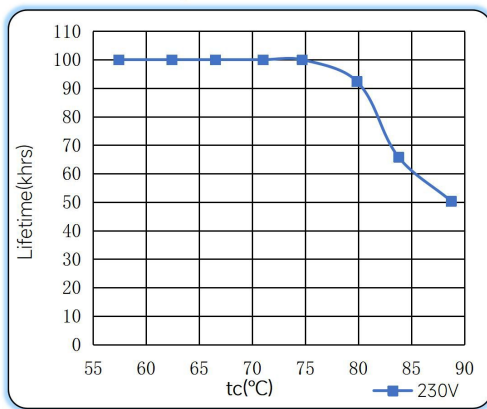

Figure 5: Est. Lifetime vs. Case Temperature



# Mechanical Characteristics

Table 4: Product Selection Guide

Characteristics	Specification
Dimensions	168.0 mm (L) x 30.0 mm (W) x 21.0 mm (H)
Enclosure Materials	Steel Metal
Weight	150.0 g
Ingress Protection	IP20

Figure 6: Mechanical Drawing

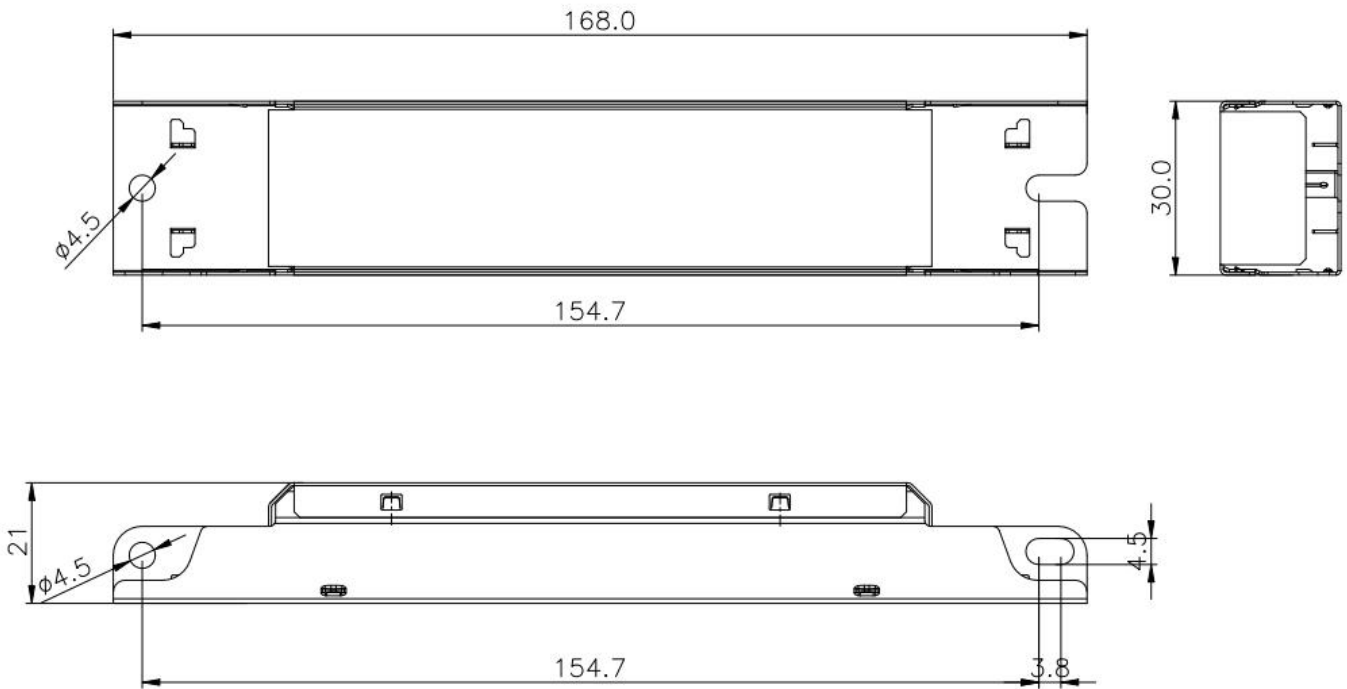

Notes for Figure 6:

1. Drawing dimensions are in millimeters
2. Unless otherwise specified, all linear tolerances are +/-1.0mm.

# Wiring Diagram

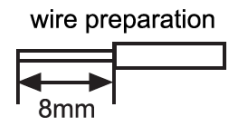
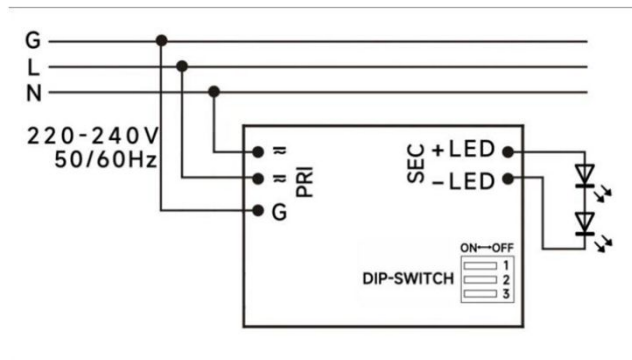

Table 5: Wiring

	Specification item	Value
PRI	Cable cross-section	0.5 – 1.5 mm <sup>2</sup> / AWG 20 – 16
	Stripping	7 - 9 mm
SEC	Cable cross-section	0.5 – 1.5 mm <sup>2</sup> / AWG 20 – 16
	Stripping	7 - 9 mm

Notes for Table 5:

1. Unless otherwise specified, all linear tolerances are +/-1.0mm

# DIP-switch operation instructions & operating window

Table 6: Dip-switch operation instructions & operating window

Dip-switch setting			U <sub>out</sub>	I <sub>out</sub>
1	2	3		
--	--	--	40 – 220V	100 mA
ON	--	--	40 – 220V	150 mA
--	ON	--	40 – 200V	200 mA
ON	ON	--	40 – 160V	250 mA
--	--	ON	40 – 133V	300 mA
ON	--	ON	40 – 114V	350 mA
--	ON	ON	40 – 100V	400 mA
ON	ON	ON	40 – 88V	450 mA

# Environmental and Regulatory Standards

Table 7: Environmental Conditions

Parameter	Specification
Ambient Operating Temperature	-25°C to + 60°C
Max. Case Temperature Tc	+85°C (max)
Humidity Rating	Maximum 85% Relative Humidity, non condensing
Storage Temperature	-40°C to + 85°C
Expected Lifetime	> 50,000 hours (Tc < 85°C) , max. 10% failure rate

Table 8: Regulatory Approvals and Compliance

Specification	Reference standard	Condition
Conducted and Radiated EMI	EN 55015:2019+A1:2020 (CISPR 15:2018)	
Harmonic Current Emissions	EN IEC 61000-3-2:2019	
Voltage Fluctuations & Flicker	IEC 61000-3-3:2013+A1:2019	
ESD (Electrostatic Discharge)	IEC 61547:2009 Section 5.2 Test des.: IEC 61000-4-2	4 kV contact discharge, 8 kV air discharge, level 3
Continuous Radiated Disturbance	IEC 61547:2009 Section 5.3 Test des.: IEC 61000-4-3	3 V/m, 80 - 1000 MHz, 80% modulated at distance of 3 meters
Electrical Fast Transient	IEC 61547:2009 Section 5.5 Test des.: IEC 61000-4-4	± 1 kV on AC power port for 1 minute,
Surge	IEC 61547 Section 5.7 Test des.: IEC 61000-4-5	± 1 kV (differential mode) ± 2 kV (common mode)
Continuous Conducted Disturbance	IEC 61547:2009 Section 5.6 Test des.: IEC 61000-4-6	3V, 0.15-80 MHz, 80% modulated, Level 2
Voltage Dips	IEC 61547 Section 5.8, 5.9 Test des.: IEC 61000-4-11	70% dip during 25 cycles @ 50Hz, 30 cycles @ 60Hz 0% dip during ½ cycles

## Regulatory Standards (continued)

Table 9: Safety Agency Approvals

Specification	Reference standard	Condition
ENEC / CE / UKCA	EN 61347-1:2015, EN 61347-2-13:2014+A1	



## Protection

Table 10: Protection

Parameters	Specification
Over Voltage Protection	Yes / Auto Resume
Short Circuit Protection	Yes / Auto Resume
Over Temperature Protection	Yes / Auto Resume Ta > 75°C, reducing Output Current



# Design Resources

## Application Notes

Please contact your Bridgelux sales representative for assistance on obtaining application support when designing with the Bridgelux Pallas-NS Single Channel Driver. For a list of available resources, visit [www.bridgelux.com](http://www.bridgelux.com).

# Precautions

## CAUTION: PRODUCT HANDLING

Handle the Pallas-NS Single Channel Driver with care to prevent any damage from mechanical shock. It is recommended to handle this driver in a static-free environment. To maintain product warranty, the product must not be opened or disassembled and the installer must ensure that the driver's operating conditions do not exceed the maximum conditions stated within this data sheet.

## CAUTION: PRODUCT INSTALLATION

Incorrect installation of the Pallas-NS Single Channel Driver can cause irreparable damage to the driver, connected LEDs. Pay attention when connecting the LED load and observe the correct polarity of the output terminals as specified in this data sheet and on the driver label. Hot plug-in or secondary switching of LEDs is not permitted and may cause a very high current to the LEDs.

## CAUTION: ELECTRIC SHOCK

Be aware of the possibility of an electric shock hazard which can result in serious injury or death. Disconnect power before servicing or installing this device.

# Disclaimers

## MINOR PRODUCT CHANGE POLICY

The rigorous qualification testing on products offered by Bridgelux provides performance assurance. Slight cosmetic changes that do not affect form, fit, or function may occur as Bridgelux continues product optimization.

## About Bridgelux: Bridging Light and Life™

At Bridgelux, we help companies, industries and people experience the power and possibility of light. Since 2002, we've designed LED solutions that are high performing, energy efficient, cost effective and easy to integrate. Our focus is on light's impact on human behavior, delivering products that create better environments, experiences and returns—both experiential and financial. And our patented technology drives new platforms for commercial and industrial luminaires.

For more information about the company, please visit

[bridgelux.com](http://bridgelux.com)

[twitter.com/Bridgelux](https://twitter.com/Bridgelux)

[facebook.com/Bridgelux](https://facebook.com/Bridgelux)

[youtube.com/user/Bridgelux](https://youtube.com/user/Bridgelux)

[linkedin.com/company/bridgelux](https://linkedin.com/company/bridgelux)

WeChat ID: BridgeluxInChina



46410 Fremont Blvd  
Fremont, CA 94538 USA  
Tel (925) 583-8400  
[www.bridgelux.com](http://www.bridgelux.com)