

Bridgelux® Fix Current Single Channel 5~15W (Nom-Dim) Slim Brick Driver

Product Data Sheet

Product Feature Map

Bridgelux Fix Current Single Channel 5~15W Driver provides dynamic constant current output for LED modules and arrays. This Driver provides fix current and allows for simple integration of Bridgelux's and all major brands White Arrays and Linear modules. Please visit www.bridgelux.com for more information.

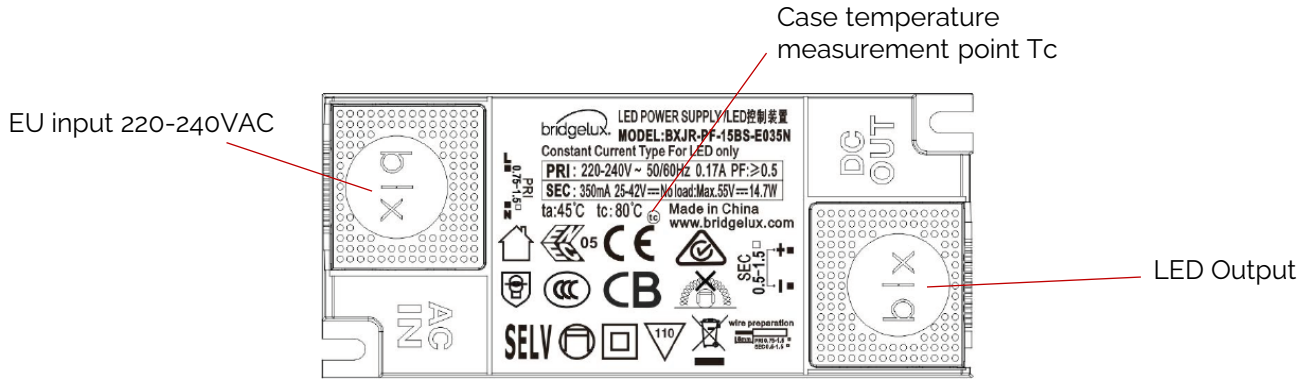

Product Nomenclature

The part number designation for Bridgelux Fix Current Single Channel 15W Driver is explained as follows:

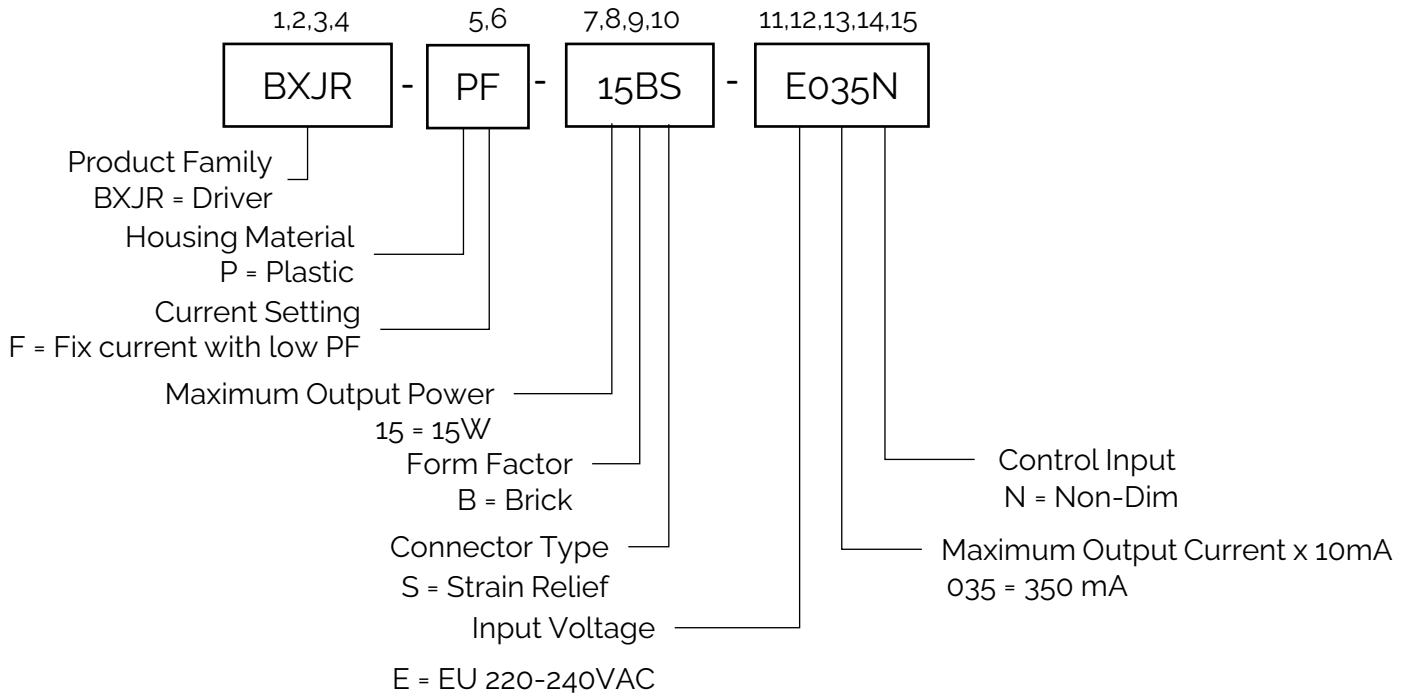

Electrical Characteristics

Table 1: Product Selection Guide

Part Number	Output Current	Input Current	Input Power	Out Power Range	PF	Efficiency	Output Voltage	No Load Voltage
BXJR-PF-05BS-E012N	120mA	0.10A	6.3W	3.0-5.0W	0.5	80%	25-42V	55V
BXJR-PF-06BS-E015N	150mA	0.10A	7.8W	3.7-6.3W	0.5	80%	25-42V	55V
BXJR-PF-07BS-E018N	180mA	0.11A	9.2W	4.5-7.56W	0.5	82%	25-42V	55V
BXJR-PF-08BS-E020N	200mA	0.12A	10.2W	5.0-8.4W	0.5	82%	25-42V	55V
BXJR-PF-09BS-E022N	220mA	0.13A	11.2W	5.5-9.24W	0.5	82%	25-42V	55V
BXJR-PF-10BS-E025N	250mA	0.13A	12.8W	6.2-10.5W	0.5	82%	25-42V	55V
BXJR-PF-12BS-E030N	300mA	0.14A	15.0W	7.5-12.6W	0.5	82%	25-42V	55V
BXJR-PF-15BS-E035N	350mA	0.15A	17.5W	8.7-14.7W	0.5	84%	25-42V	55V
BXJR-PF-05BS-E050N	500mA	0.12A	6.25W	2.5-5.0W	0.5	80%	5-10V	22V
BXJR-PF-06BS-E060N	600mA	0.13A	7.50W	3.0-6.0W	0.5	80%	5-10V	22V
BXJR-PF-07BS-E070N	700mA	0.14A	8.75W	3.5-7.0W	0.5	80%	5-10V	22V

Table 2: Input Electrical Characteristics

Parameter	Unit	Specification
Nominal voltage	V	220 – 240
Nominal frequency	Hz	50 / 60
AC voltage range	V	198 – 264
Nominal current	A	0.15
Power factor (Full load)	-	0.5
THD (Full load)	%	comply with EN61000-3-2
DF	-	≥ 0.7 @230VAC
Efficiency (Full load)	%	≥ 80
NO load	W	≤ 0.5
Protection class	-	II
Inrush current(Cold start)	A pk	< 20 (th = 400 μs)
Max. units per circuit breaker	-	B10: 30 B16: 48 C10: 48 C16: 77

Electrical Characteristics

Table 3: Output Electrical Characteristics

Parameter	Unit	Specification
Nominal voltage range	V	3-10V/25-42V
Maximum voltage(Open Circuit)	Vdc	≤ 55
Nominal current	mA	120/150/180/200/220/250/300/350/500/600/700
Current accuracy	%	+/- 7
Current ripple LF < 200Hz	%	≤ 5
Pst LM	-	≤ 1
SVM	-	≤ 0.4
Maximum power	W	14.7
Galvanic isolation: SELV	-	Output voltage of SELV controlgear not exceed limits in 10.4 of IEC61347-1 during the test of 15.1 and 15.2 <i>IEC61347-1 10.4: "Controlgear providing SELV may have accessible conductive parts in the SELV circuit; if : the rated output voltage exceed 60V ripple free d.c., the touch current does not exceed 0.7 mA (peak).</i>

Figure 1: Power Factor vs. Load

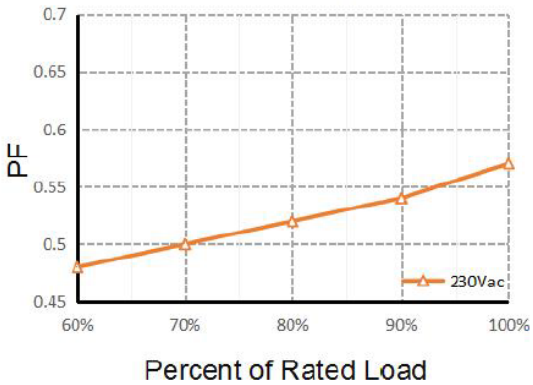

Figure 2: Total Harmonic Distortion vs. Load

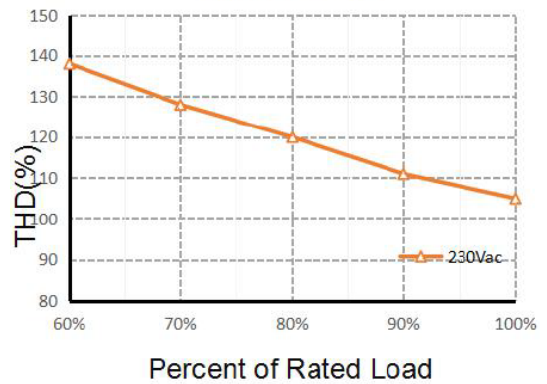

Figure 3: Efficiency vs. Load

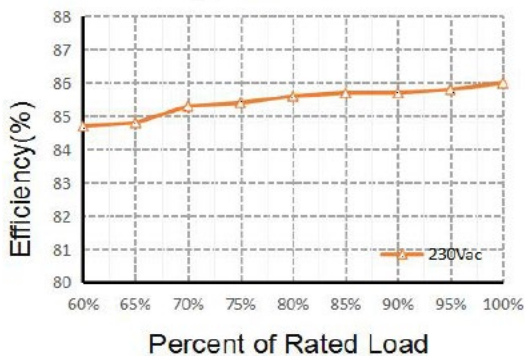
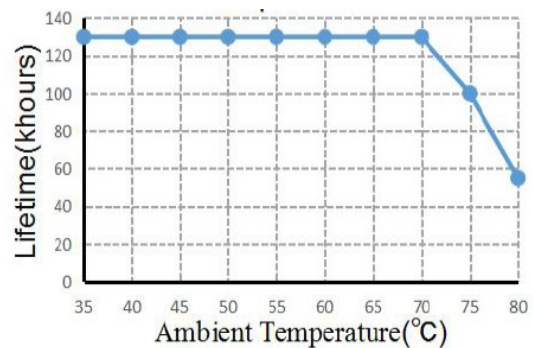

Figure 4: Expected Life Time



Mechanical Characteristics

Table 4: Product Selection Guide

Characteristics	Specification
Dimensions	82.8.0 mm (L) x 40.0 mm (W) x 23.0 mm (H)
Enclosure Materials	PC Plastic
Weight	45 g
Ingress Protection	IP20

Figure 5: Mechanical Drawing

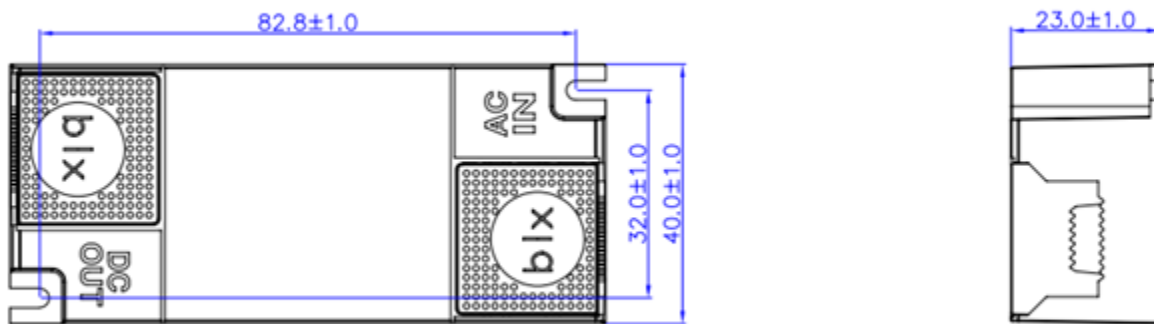

Notes for Figure 5:

1. Drawing dimensions are in millimeters
2. Unless otherwise specified, all linear tolerances are ± 1.0 mm

Wiring Diagram

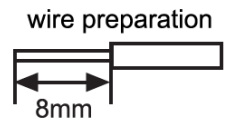
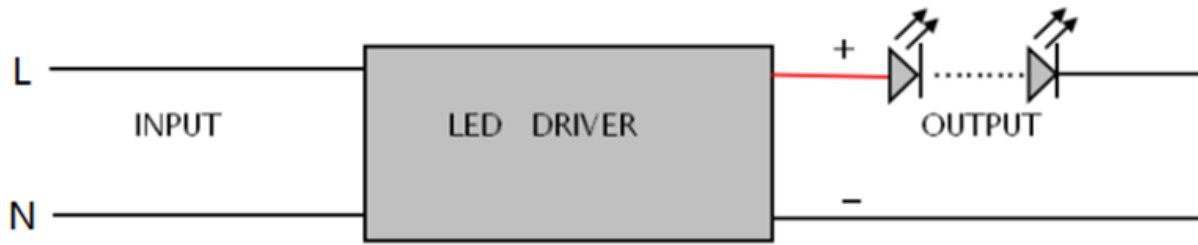

Table 5: **Wiring**

PRI		
PRI	Cable cross-section	0.75 – 1.5 mm ² / AWG 18 - 15
	Stripping	8 mm
SEC	Cable cross-section	0.5 – 0.75 mm ² / AWG 20 - 18
	Stripping	8 mm

Notes for Table 5:

1. Hot plug-in or secondary switching of LEDs is not permitted and may cause a very high current to the LEDs.
2. Unless otherwise specified, all linear tolerances are +/-1.0mm

Environmental and Regulatory Standards

Table 6: Environmental Conditions

Parameter	Specification
Ambient Operating Temperature	-20°C to + 45°C
Max. Case Temperature Tc	+80°C (max)
Max. Case Temperature (In fault condition)	+90°C
Humidity Rating	Maximum 85% Relative Humidity, non condensing
Storage Temperature	-20°C to + 85°C
Expected Lifetime	50,000 hours (Tc < 80°C)

Table 7: Regulatory Approvals and Compliance

Specification	Reference Standard	Condition
DC or AC supplied electronic controlgear for LED modules	EN 62384	electronic controlgear for use on DC or AC supplies up to 1 000 V (alternating current at 50 Hz or 60 Hz) and with an output frequency which can deviate from the supply frequency
Conducted and Radiated EMI	EN 55015:2019+A1:2020 (CISPR 15:2018)	
Harmonic Current Emissions	EN IEC 61000-3-2:2019	
Voltage Fluctuations & Flicker	IEC 61000-3-3:2013+A1:2019	
ESD (Electrostatic Discharge)	IEC 61547:2009 Section 5.2 Test des.: IEC 61000-4-2	4 kV contact discharge, 8 kV air discharge, level 3
Continuous Radiated Disturbance	IEC 61547:2009 Section 5.3 Test des.: IEC 61000-4-3	3 V/m, 80 - 1000 MHz, 80% modulated at distance of 3 meters
Electrical Fast Transient	IEC 61547:2009 Section 5.5 Test des.: IEC 61000-4-4	± 1 kV on AC power port for 1 minute,
Surge	IEC 61547 Section 5.7 Test des.: IEC 61000-4-5	± 1 kV (differential mode) ± 2 kV (common mode)
Continuous Conducted Disturbance	IEC 61547:2009 Section 5.6 Test des.: IEC 61000-4-6	3V, 0.15-80 MHz, 80% modulated, Level 2
Voltage Dips	IEC 61547 Section 5.8, 5.9 Test des.: IEC 61000-4-11	70% dip during 25 cycles @ 50Hz, 30 cycles @ 60Hz 0% dip during ½ cycles
Touch Current	EN60598-1	lower than 0.7 mA, according to EN 60598-1 annex. G and EN 61347-1 annex A

Regulatory Standards (continued)

Table 8: Safety Agency Approvals

Specification	Reference Standard	Condition
ENEC / CE / UKCA	EN 61347-1:2015, EN 61347-2-13:2014+A1	
Glow wire test	EN 61347-1:2015	Passed with increased temperature at 850°C

Protection

Table 9: Protection

Parameters	Specification
Over Load Protection	Yes / Auto Resume
Over Voltage Protection	Yes / Auto Resume
Short Circuit Protection	Yes / Auto Resume

Packaging

Table 10: Packaging Box Configuration

Parameters	Specification
Driver quantity	100 pcs
Outer dimensions	390 X 225 X 190 mm
Weight	5.0 kg

Design Resources

Application Notes

Please contact your Bridgelux sales representative for assistance on obtaining application support when designing with the Bridgelux Fix Current Single Channel Driver. For a list of available resources, visit www.bridgelux.com.

Precautions

CAUTION: PRODUCT HANDLING

Handle the Fix Current Single Channel Driver with care to prevent any damage from mechanical shock. It is recommended to handle this driver in a static-free environment. Do not open or disassemble the product. To maintain product warranty, the installer is responsible for ensuring that the driver's operating conditions do not exceed the maximum conditions stated within this data sheet.

CAUTION: PRODUCT INSTALLATION

Incorrect installation of the Fix Current Single Channel Driver can cause irreparable damage to the driver, connected LEDs. Pay attention when connecting the LED load and observe the correct polarity of the output terminals as specified in this data sheet and on the driver label.

CAUTION: ELECTRIC SHOCK

Be aware of the possibility of an electric shock hazard which can result in serious injury or death. Disconnect power before servicing or installing this device.

Disclaimers

MINOR PRODUCT CHANGE POLICY

The rigorous qualification testing on products offered by Bridgelux provides performance assurance. Slight cosmetic changes that do not affect form, fit, or function may occur as Bridgelux continues product optimization.

About Bridgelux: Bridging Light and Life™

At Bridgelux, we help companies, industries and people experience the power and possibility of light. Since 2002, we've designed LED solutions that are high performing, energy efficient, cost effective and easy to integrate. Our focus is on light's impact on human behavior, delivering products that create better environments, experiences and returns—both experiential and financial. And our patented technology drives new platforms for commercial and industrial luminaires.

For more information about the company, please visit

bridgelux.com

twitter.com/Bridgelux

facebook.com/Bridgelux

youtube.com/user/Bridgelux

linkedin.com/company/bridgelux

WeChat ID: BridgeluxInChina



46410 Fremont Blvd

Fremont, CA 94538 USA

Tel (925) 583-8400

www.bridgelux.com