



# Bridgelux® SMD 3030 0.2W 3V

Product Data Sheet DS1708

# Introduction

SMD 3030

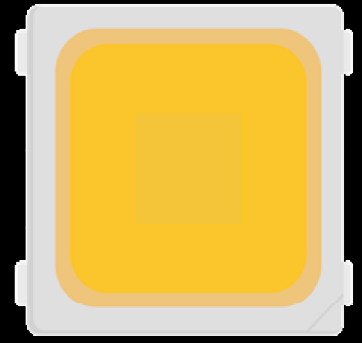

## Features

- Industry-standard 3030 footprint
- Enables 3- and 6-step MacAdam ellipse custom binning kits
- RoHS compliant and lead free
- Multiple CCT configurations for a wide range of lighting applications
- High efficacy solution

## Benefits

- Lower operating and manufacturing cost
- Ease of design and rapid go-to-market
- Uniform, consistent white light
- Reliable and constant white point
- Compliant with environmental standards
- Design flexibility

# Contents

Product Feature Map	2
Product Nomenclature	2
Product Selection Guide	3
Electrical Characteristics	4
PPF&PPE Characteristics	6
Absolute Maximum Ratings	6
Product Bin Definitions	7
Performance Curves	10
Typical Radiation Pattern	13
Typical Color Spectrum	14
Mechanical Dimensions	15
Reliability	16
Reflow Characteristics	17
Packaging	18
Design Resources	20
Precautions	20
Disclaimers	20
About Bridgelux	21

# Product Feature Map

Bridgelux SMD LED products come in industry standard package sizes and follow ANSI binning standards. These LEDs are optimized for cost and performance, helping to ensure highly competitive system lumen per dollar performance while addressing the stringent efficacy and reliability standards required for modern lighting applications.

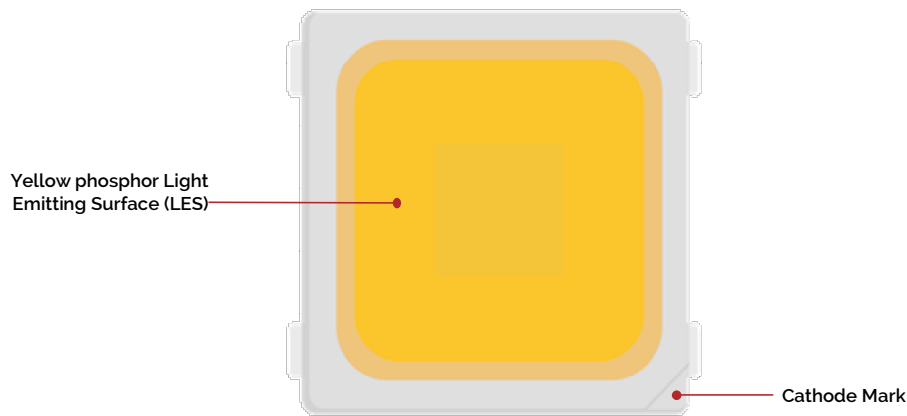

## Product Nomenclature

The part number designation for Bridgelux SMD 3030 is explained as follows:

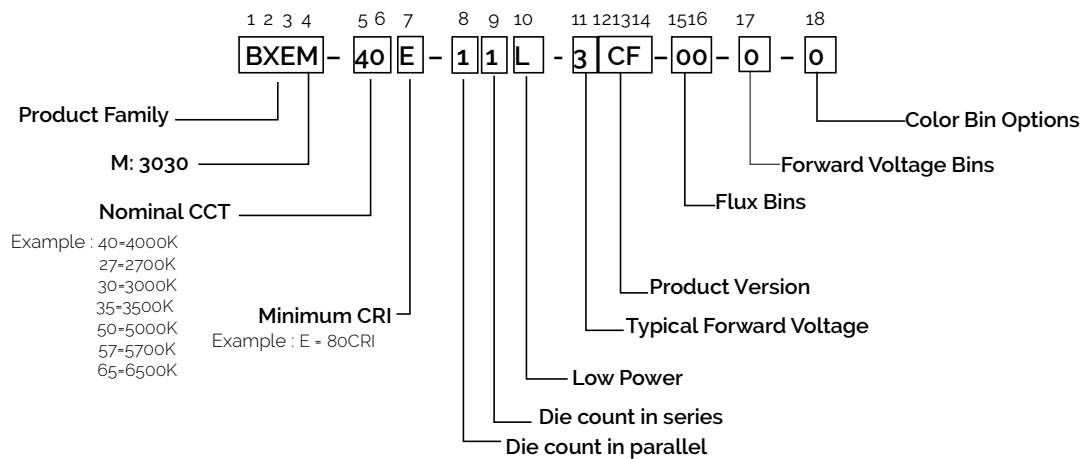

# Product Selection Guide

The following product configurations are available:

**Table 1:** Selection Guide, Pulsed Measurement Data at 65mA ( $T_j = T_{sp} = 25^\circ\text{C}$ )

Part Number <sup>1,6</sup>	Nominal CCT <sup>2</sup> (K)	CRI <sup>3,5</sup>	Nominal Drive Current (mA)	Forward Voltage <sup>4,5</sup> (V)			Typical Pulsed Flux (lm) <sup>4,5</sup>	Typical Power (W)	Typical Efficacy (lm/W)
				Min	Typical	Max			
BXEM-27E-11L-3CF-00-0-0	2700	80	65	2.6	2.7	2.8	36.0	0.2	205
BXEM-30E-11L-3CF-00-0-0	3000	80	65	2.6	2.7	2.8	37.0	0.2	211
BXEM-35E-11L-3CF-00-0-0	3500	80	65	2.6	2.7	2.8	38.0	0.2	217
BXEM-40E-11L-3CF-00-0-0	4000	80	65	2.6	2.7	2.8	39.5	0.2	225
BXEM-50E-11L-3CF-00-0-0	5000	80	65	2.6	2.7	2.8	39.5	0.2	225
BXEM-57E-11L-3CF-00-0-0	5700	80	65	2.6	2.7	2.8	39.0	0.2	222
BXEM-65E-11L-3CF-00-0-0	6500	80	65	2.6	2.7	2.8	38.0	0.2	217

**Table 2:** Selection Guide, Pulsed Test Performance ( $T_{sp} = 85^\circ\text{C}$ )<sup>7,8</sup>

Part Number <sup>1,6</sup>	Nominal CCT <sup>2</sup> (K)	CRI <sup>3,5</sup>	Nominal Drive Current (mA)	Forward Voltage <sup>4,5</sup> (V)			Typical Pulsed Flux (lm) <sup>4,5</sup>	Typical Power (W)	Typical Efficacy (lm/W)
				Min	Typical	Max			
BXEM-27E-11L-3CF-00-0-0	2700	80	65	2.55	2.65	2.75	32.6	0.2	190
BXEM-30E-11L-3CF-00-0-0	3000	80	65	2.55	2.65	2.75	34.0	0.2	198
BXEM-35E-11L-3CF-00-0-0	3500	80	65	2.55	2.65	2.75	35.0	0.2	203
BXEM-40E-11L-3CF-00-0-0	4000	80	65	2.55	2.65	2.75	36.3	0.2	210
BXEM-50E-11L-3CF-00-0-0	5000	80	65	2.55	2.65	2.75	36.3	0.2	210
BXEM-57E-11L-3CF-00-0-0	5700	80	65	2.55	2.65	2.75	35.9	0.2	208
BXEM-65E-11L-3CF-00-0-0	6500	80	65	2.55	2.65	2.75	35.0	0.2	203

Notes for Tables 1 & 2:

- The last 6 characters (including hyphens '-') refer to flux bins, forward voltage bins, and color bin options, respectively. "00-0-0" denotes the full distribution of Flux, forward voltage, and color bin.
- Example: BXEM-40E-11L-3CF-00-0-0 refers to the full distribution of flux, forward voltage, and color within a 4000K 6-step ANSI standard chromaticity region with a minimum of 90 CRI, 1 die configuration, low power, 2.7V typical forward voltage.
- Product CCT is the nominal CCT at  $T_{sp} = 25^\circ\text{C}$  as defined by ANSI C78.377-2011.
- Listed CRIs are minimum values.
- Products tested under pulsed condition (10ms pulse width) at nominal drive current.
- Bridgelux maintains a  $\pm 7.5\%$  tolerance on luminous flux measurements,  $\pm 0.1\text{V}$  tolerance on forward voltage measurements, and  $\pm 2$  tolerance on CRI measurements for the SMD 3030.
- Refer to Table 6 and Table 7 for Bridgelux SMD 3030 Luminous Flux Binning and Forward Voltage Binning information.
- Typical pulsed test performance values are provided as reference only and are not a guarantee of performance.
- Typical performance is estimated based on operation under pulsed current with LED emitter mounted onto a heat sink with thermal interface material and the solder point temperature maintained at  $85^\circ\text{C}$ . Based on Bridgelux test setup, values may vary depending on the thermal design of the luminaire and the exposed environment to which the product is subjected.
- In order to ensure the accuracy of the test by Everfine sphere the test model suggest to use conventional test preheat for 30ms integrating time for 20ms. If using pulse model, pulse width suggest to use IP 80-90%. Hot cold test must use conventional test and wavelength accuracy is required to be 1nm. The test conditions must be fixed.

## Electrical Characteristics

Table 3: SMD 3030 LEDs specifications at nominal drive current are shown in Table 1 and Table 2. SMD 3030 may also be driven at other drive currents dependent on specific application design requirements. The performance at any drive current can be derived from the current vs. voltage characteristics shown in Figure 2 and the relative luminous flux vs. current characteristics shown in Figure 3. The performance at commonly used drive currents is summarized in Table 3.

**Table 3:** Performance at Commonly Used Drive Currents

Part Number	CRI	Drive Current (mA)	Typical Vf(V) T <sub>sp</sub> = 25°C	Typical Power (W) T <sub>sp</sub> = 25°C	Typical Pulsed Flux (lm) <sup>1,2</sup> T <sub>sp</sub> = 25°C	Typical Pulsed Flux (lm) <sup>1,2</sup> T <sub>sp</sub> = 85°C	Typical Efficacy (lm/W) T <sub>sp</sub> = 25°C
BXEM-27E-11L-3CF-00-0-0	80	20	2.60	0.052	11.0	10.0	211
		65	2.69	0.175	36.0	32.6	206
		100	2.72	0.272	54.3	49.2	200
		150	2.77	0.416	80.5	72.9	194
		200	2.82	0.564	105.9	95.9	188
		250	2.86	0.716	130.6	118.3	182
		300	2.90	0.871	154.6	140.1	177
		350	2.94	1.029	177.8	161.1	173
BXEM-30E-11L-3CF-00-0-0	80	20	2.60	0.052	11.3	10.4	218
		65	2.69	0.175	37.0	34.0	212
		100	2.72	0.272	55.8	51.3	205
		150	2.77	0.416	82.6	75.9	199
		200	2.82	0.564	108.7	99.9	193
		250	2.86	0.716	134.1	123.2	187
		300	2.90	0.871	158.7	145.8	182
		350	2.94	1.029	182.5	167.7	177
BXEM-35E-11L-3CF-00-0-0	80	20	2.60	0.052	11.7	10.7	224
		65	2.69	0.175	38.00	35.0	217
		100	2.72	0.272	57.3	52.8	211
		150	2.77	0.416	84.9	78.2	204
		200	2.82	0.564	111.7	102.8	198
		250	2.86	0.716	137.7	126.8	192
		300	2.90	0.871	163.0	150.1	187
		350	2.94	1.029	187.5	172.7	182
BXEM-40E-11L-3CF-00-0-0 BXEM-50E-11L-3CF-00-0-0	80	20	2.60	0.052	12.3	11.3	237
		65	2.69	0.175	39.5	36.3	226
		100	2.72	0.272	60.7	55.8	223
		150	2.77	0.416	89.6	82.4	216
		200	2.82	0.564	117.7	108.1	209
		250	2.86	0.716	144.7	133.0	202
		300	2.90	0.871	170.9	157.0	196
		350	2.94	1.029	196.0	180.2	190

# Electrical Characteristics

Part Number	CRI	Drive Current (mA)	Typical Vf(V) T <sub>sp</sub> = 25°C	Typical Power (W) T <sub>sp</sub> = 25°C	Typical Pulsed Flux (lm) <sup>1,2</sup> T <sub>sp</sub> =25°C	Typical Pulsed Flux (lm) <sup>1,2</sup> T <sub>sp</sub> =85°C	Typical Efficacy (lm/W) T <sub>sp</sub> = 25°C
BXEM-57E-11L-3CF-00-0-0	80	20	2.60	0.052	11.7	10.7	224
		65	2.69	0.175	39.0	35.9	223
		100	2.72	0.272	57.3	52.8	211
		150	2.77	0.416	84.9	78.1	204
		200	2.82	0.564	111.7	102.8	198
		250	2.86	0.716	137.7	126.7	192
		300	2.90	0.871	163.0	150.0	187
		350	2.94	1.029	187.5	172.6	182
BXEM-65E-11L-3CF-00-0-0	80	20	2.60	0.052	11.4	10.5	219
		65	2.69	0.175	38.0	35.0	217
		100	2.72	0.272	56.0	51.6	206
		150	2.77	0.416	82.9	76.4	200
		200	2.82	0.564	109.1	100.5	193
		250	2.86	0.716	134.5	123.8	188
		300	2.90	0.871	159.1	146.5	183
		350	2.94	1.029	182.9	168.5	178

Notes for Table 3:

1. Alternate drive currents in Table 3 are provided for reference only and are not a guarantee of performance.
2. Bridgelux maintains a ± 7.5% tolerance on flux measurements.
3. Typical pulsed performance values are provided as reference only and are not a guarantee of performance.

**Table 4:** Electrical Characteristics

Part Number <sup>1</sup>	Drive Current (mA)	Forward Voltage (V) <sup>1,2</sup>			Typical Temperature Coefficient of Forward Voltage $\Delta V_f / \Delta T$ (mV/°C)	Typical Thermal Resistance Junction to Solder Point <sup>3</sup> $R_{j-sp}$ (°C/W)
		Minimum	Typical	Maximum		
BXEM-xxE-11L-3CF-00-0-0	65	2.6	2.7	2.8	-1.03	75

Notes for Table 4:

1. Bridgelux maintains a tolerance of ± 0.1V on forward voltage measurements. Voltage minimum and maximum values at the nominal drive current are guaranteed by 100% test.
2. Products tested under pulsed condition (10ms pulse width) at nominal drive current where T<sub>sp</sub> = 25°C.
3. Thermal resistance value was calculated using total electrical input power; optical power was not subtracted from input power.

# Product Bin Definitions

**Table 5:** Electro-optical Characteristics ( $I_F = 65 \text{ mA}$ ,  $T_s = 25^\circ\text{C}$ )

Part Number <sup>1</sup>	$I_f$ [mA]	5	35	65	110	155	200	245	305	350
	$V_f$ [V]	2.56	2.64	2.68	2.73	2.78	2.82	2.85	2.91	2.94
BXEM-27E-11L-3CF-00-0-0	PPF[ $\mu\text{mol/s}$ ]	0.04	0.28	0.51	0.86	1.19	1.51	1.82	2.23	2.52
	PPE[ $\mu\text{mol/J}$ ]	2.94	3.01	2.94	2.85	2.76	2.68	2.61	2.52	2.45
BXEM-30E-11L-3CF-00-0-0	PPF[ $\mu\text{mol/s}$ ]	0.04	0.28	0.51	0.86	1.19	1.51	1.83	2.24	2.53
	PPE[ $\mu\text{mol/J}$ ]	2.96	3.01	2.95	2.85	2.77	2.69	2.62	2.52	2.46
BXEM-35E-11L-3CF-00-0-0	PPF[ $\mu\text{mol/s}$ ]	0.04	0.28	0.52	0.87	1.22	1.55	1.87	2.29	2.59
	PPE[ $\mu\text{mol/J}$ ]	3.02	3.07	3.01	2.91	2.83	2.75	2.68	2.58	2.52
BXEM-40E-11L-3CF-00-0-0 BXEM-50E-11L-3CF-00-0-0	PPF[ $\mu\text{mol/s}$ ]	0.04	0.29	0.54	0.90	1.24	1.58	1.91	2.34	2.65
	PPE[ $\mu\text{mol/J}$ ]	3.13	3.15	3.08	2.98	2.89	2.81	2.73	2.64	2.57
BXEM-57E-11L-3CF-00-0-0 BXEM-65E-11L-3CF-00-0-0	PPF[ $\mu\text{mol/s}$ ]	0.04	0.28	0.52	0.87	1.22	1.55	1.87	2.29	2.59
	PPE[ $\mu\text{mol/J}$ ]	3.02	3.07	3.01	2.91	2.83	2.75	2.68	2.58	2.52

Note for Table 5:

Bridgelux maintains a tolerance of  $\pm 5\%$  on PPF measurements.

**Table 6:** Maximum Ratings

Parameter	Maximum Rating
LED Junction Temperature ( $T_j$ )	125°C
Storage Temperature	-40°C to +105°C
Operating Solder Point Temperature ( $T_{sp}$ )	-40°C to +105°C
Soldering Temperature	260°C or lower for a maximum of 10 seconds
Maximum Drive Current	350mA
Maximum Peak Pulsed Forward Current <sup>1</sup>	500mA
Maximum Reverse Voltage <sup>2</sup>	-
Moisture Sensitivity Rating	MSL 3
Electrostatic Discharge	8kV HBM, JEDEC-JS-001-HBM and JEDEC-JS-001-2012

Notes for Table 6:

- Bridgelux recommends a maximum duty cycle of 10% and pulse width of 10 ms when operating LED SMD at maximum peak pulsed current specified. Maximum peak pulsed current indicate values where LED SMD can be driven without catastrophic failures.
- Light emitting diodes are not designed to be driven in reverse voltage and will not produce light under this condition. no rating is provided



# Product Bin Definitions

Table 7 : lists the standard photometric luminous bins for Bridgelux SMD 3030 LEDs. Although several bins are listed, product availability in a particular bin varies by production run and by product performance. Not all bins are available in all CCTs.

**Table 7:** Luminous flux Bin Definitions at 65mA,  $T_{sp}=25^{\circ}\text{C}$

Bin Code	Minimum	Maximum	Unit	Condition
1G	34	36	lm	$I_F=65\text{mA}$
1H	36	38		
1J	38	40		
1K	40	42		

Note for Table 7:

1. Bridgelux maintains a tolerance of  $\pm 7.5\%$  on luminous flux measurements.

**Table 8:** Forward Voltage Bin Definition at 65mA,  $T_{sp}=25^{\circ}\text{C}$

Bin Code	Minimum	Maximum	Unit	Condition
8	2.6	2.7	V	$I_F=65\text{mA}$
9	2.7	2.8		
A	2.8	2.9		

Note for Table 8:

1. Bridgelux maintains a tolerance of  $\pm 0.1\text{V}$  on forward voltage measurements.

# Product Bin Definitions

**Table 9:** MacAdam Ellipse Color Bin Definitions

CCT	Color Space	Center Point		Major Axis	Minor Axis	Ellipse Rotation Angle	Color Bin
		X	Y				
2700K	3 SDCM	0.4578	0.4101	0.0081	0.0042	53.70	1
	6 SDCM	0.4578	0.4101	0.0162	0.0084	53.70	1/A/B/C/D
3000K	3 SDCM	0.4338	0.4030	0.00834	0.00408	53.22	1
	6 SDCM	0.4338	0.4030	0.01668	0.00816	53.22	1/A/B/C/D
3500K	3 SDCM	0.4078	0.3930	0.00834	0.00408	54.00	1
	6 SDCM	0.4078	0.3930	0.01668	0.00816	54.00	1/A/B/C/D
4000K	3 SDCM	0.3818	0.3797	0.00939	0.00402	53.72	1
	6 SDCM	0.3818	0.3797	0.01878	0.00804	53.72	1/A/B/C/D
5000K	3 SDCM	0.3447	0.3553	0.00822	0.00354	59.62	1
	6 SDCM	0.3447	0.3553	0.01644	0.00708	59.62	1/A/B/C/D
5700K	3 SDCM	0.3287	0.3417	0.00746	0.00320	59.09	1
	6 SDCM	0.3287	0.3417	0.01492	0.0064	59.09	1/A/B/C/D
6500K	3 SDCM	0.3123	0.3282	0.00669	0.00285	58.57	1
	6 SDCM	0.3123	0.3282	0.01338	0.0057	58.57	1/A/B/C/D

Notes for Table 9:

1. Color binning at  $T_{sp} = 85^{\circ}\text{C}$  unless otherwise specified.
2. Bridgelux maintains a tolerance of  $\pm 0.007$  on x and y color coordinates in the CIE 1931 color space.

# Product Bin Definitions

**Figure 1: C.I.E. 1931 Chromaticity Diagram (5 Color Bin Structure, Hot-color Targeted at  $T_{sp} = 85^{\circ}\text{C}$ )**

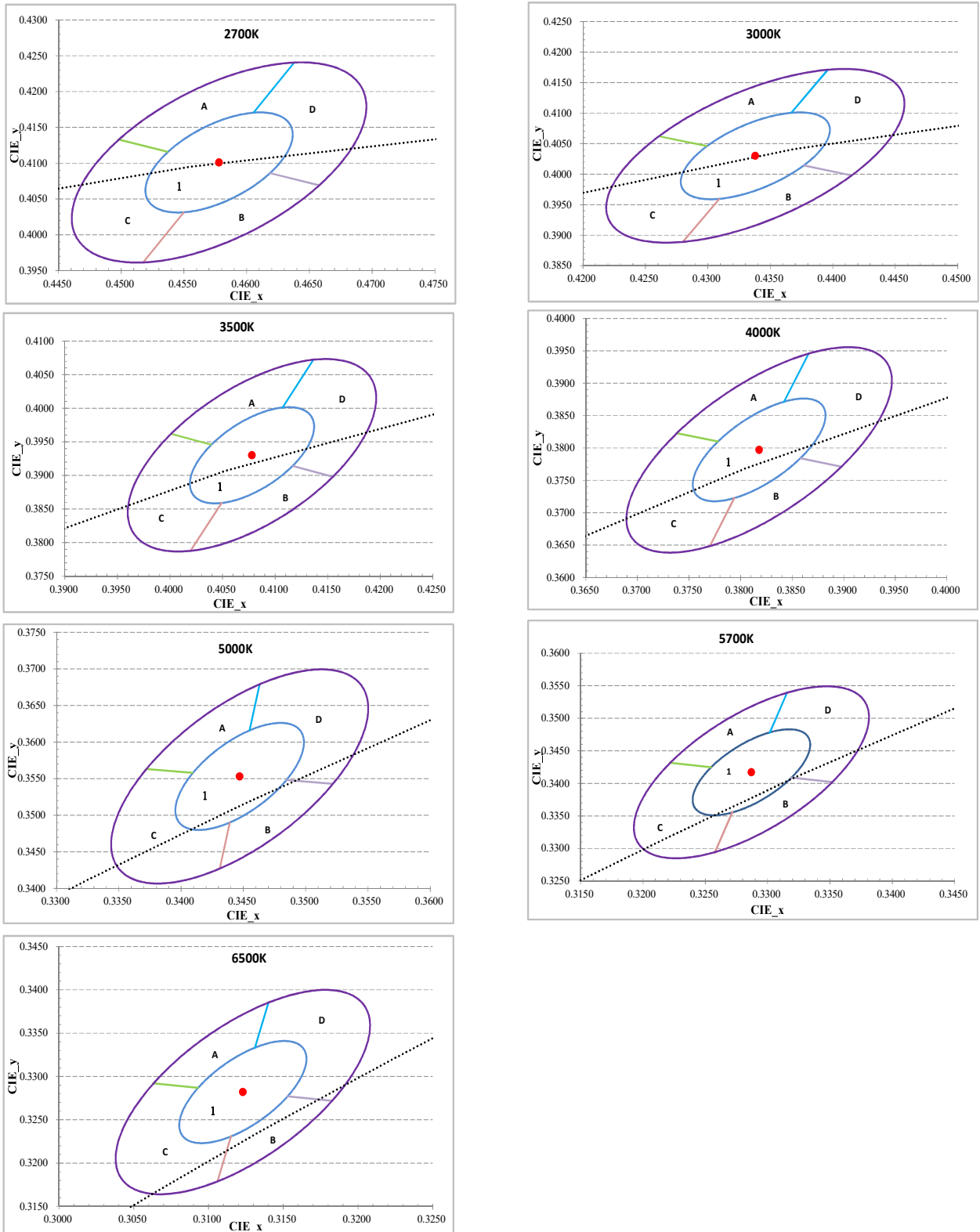

# Performance Curves

Figure 2: Drive Current vs. Forward Voltage ( $T_{sp}=25^{\circ}\text{C}$ )

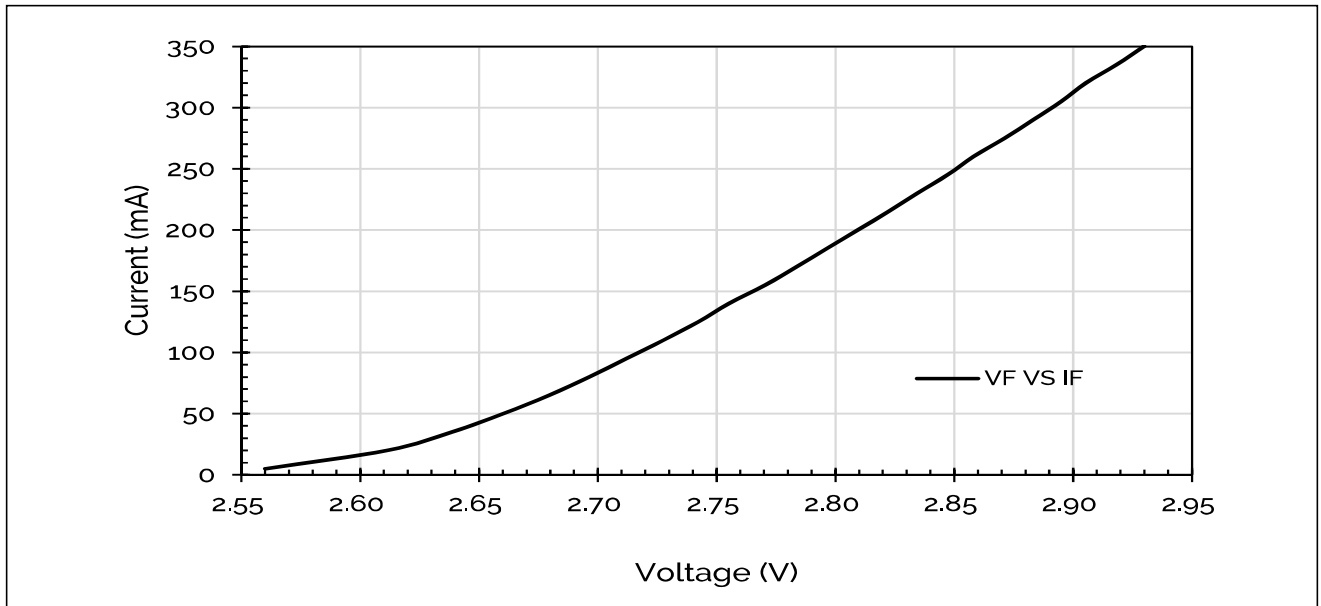
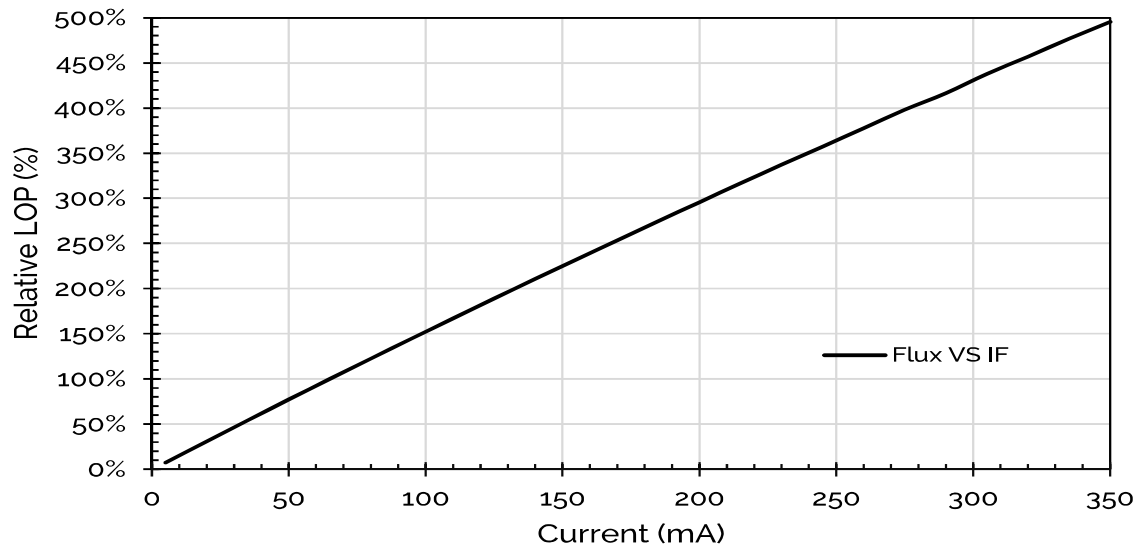

Figure 3: Typical Relative Luminous Flux vs. Forward Current ( $T_{sp}=25^{\circ}\text{C}$ )



Note for Figure 3:

1. Pulse width modulation (PWM) is recommended for dimming effects.

# Performance Curves

**Figure 4: Typical Relative Flux vs. Solder Point Temperature**

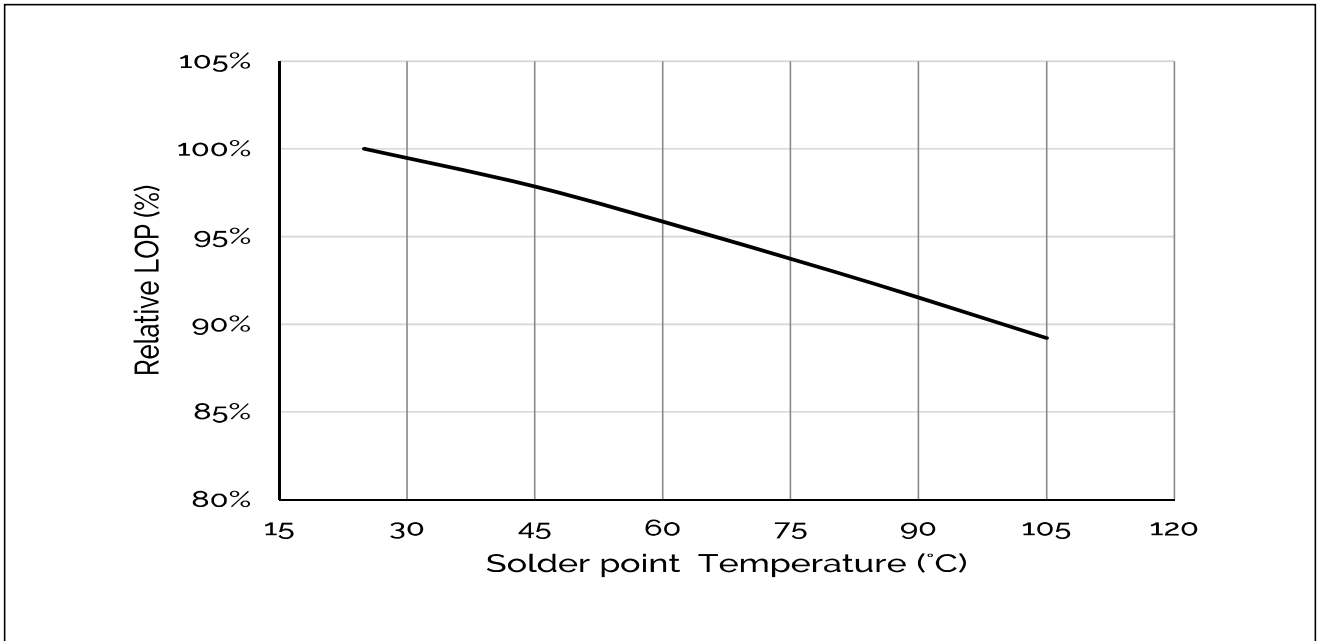

**Figure 5: Typical ccx Shift vs. Solder Point Temperature**

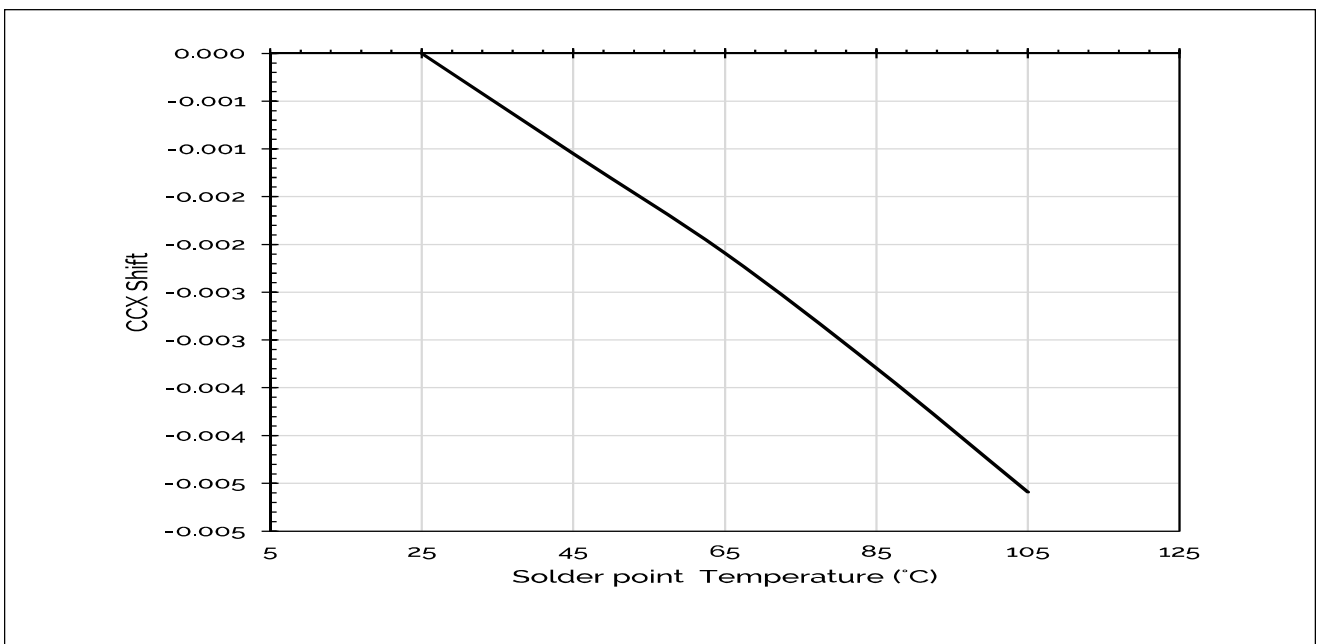

Notes for Figures 4 & 5:

1. Characteristics shown for neutral white based on 4000K and 90 CRI.
2. For other color SKUs, the shift in color will vary. Please contact your Bridgelux Sales Representative for more information

# Performance Curves

**Figure 6: Typical ccy Shift vs. Solder Point Temperature**

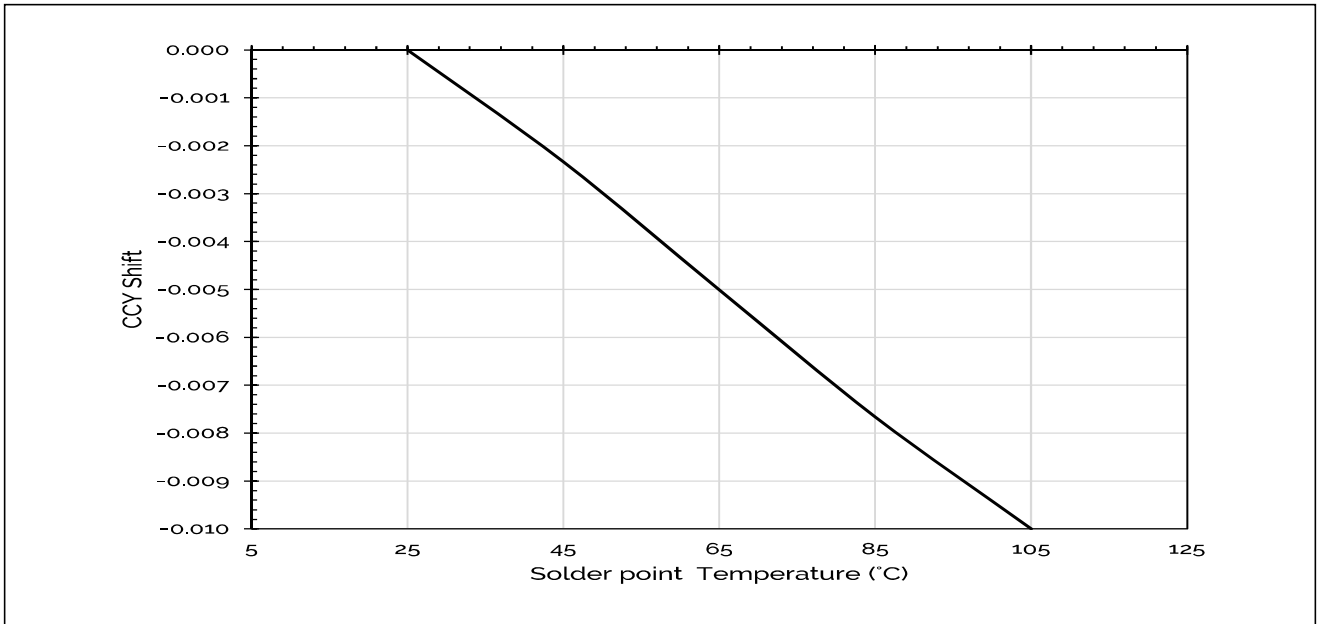

Notes for Figure 6:

1. Characteristics shown for neutral white based on 4000K and 90 CRI.
2. For other color SKUs, the shift in color will vary. Please contact your Bridgelux Sales Representative for more information.

**Figure 7: Drive Current vs Solder Point Temperature**

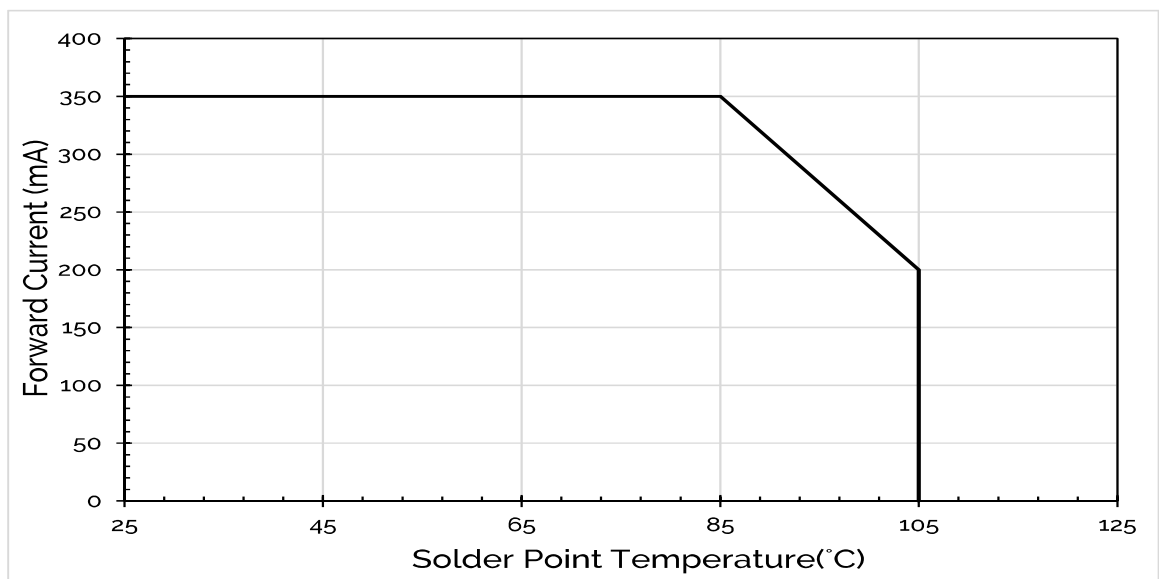

# Typical Radiation Pattern

Figure 8: Typical Spatial Radiation Pattern at 65mA,  $T_{sp} = 25^{\circ}\text{C}$

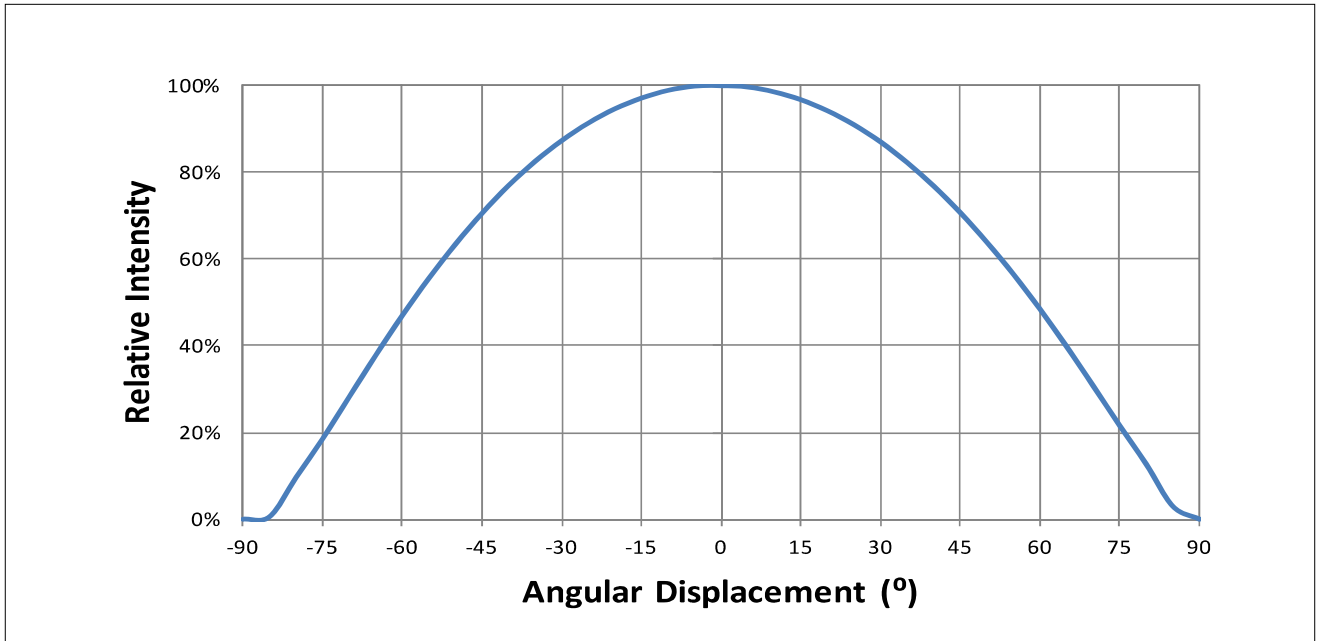

Notes for Figure 8:

1. Typical viewing angle is  $120^{\circ}$ .
2. The viewing angle is defined as the off axis angle from the centerline where luminous intensity (Iv) is  $\frac{1}{2}$  of the peak value.

Figure 9: Typical Polar Radiation Pattern at 65mA,  $T_{sp} = 25^{\circ}\text{C}$

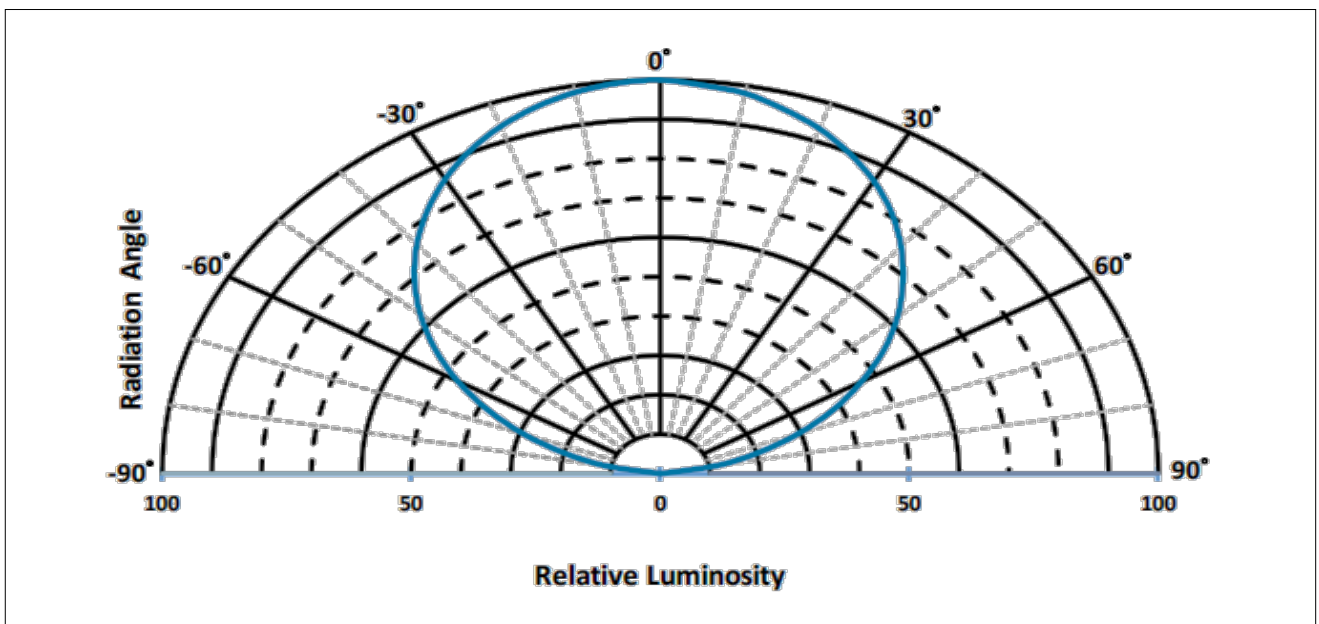

# Typical Color Spectrum

Figure 10: Typical Color Spectrum

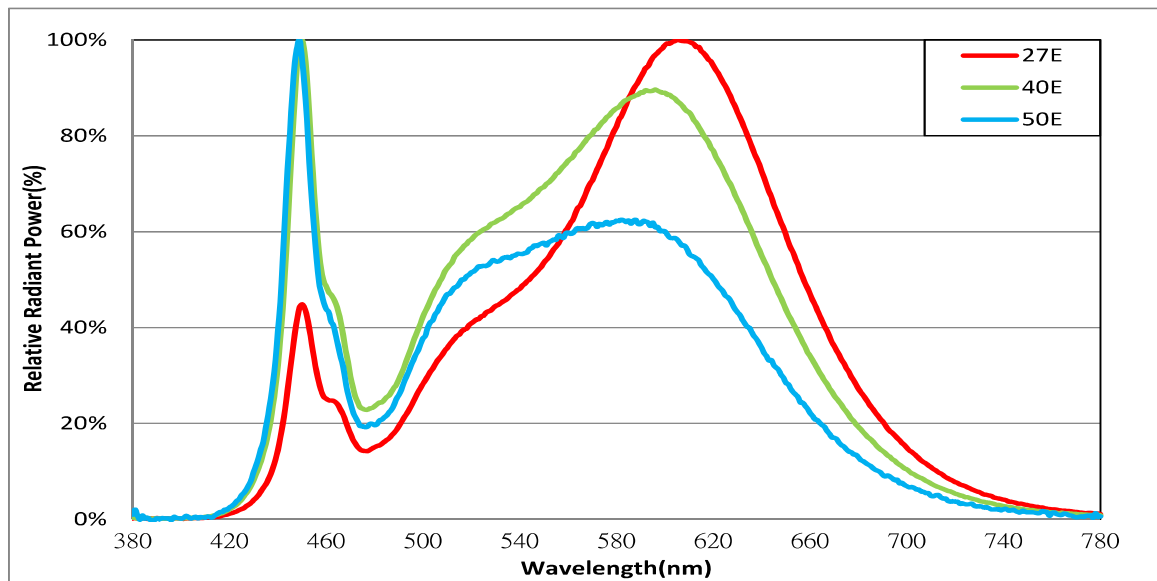

Notes for Figure 10:

1. Color spectra measured at nominal current for  $T_{sp} = 25^{\circ}\text{C}$
2. Color spectra shown for 2700K/4000K/5000K CRI80 products.



# Mechanical Dimensions

**Figure 11: Drawing for SMD 3030**

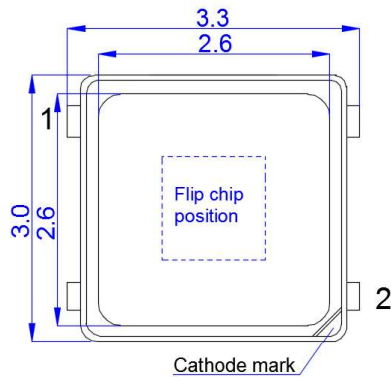

**Top View**

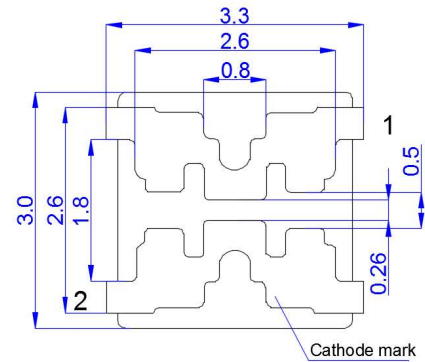

**Bottom View**

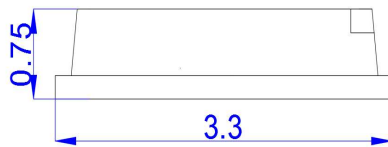

**Side View**

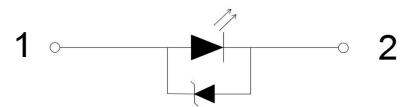

**Circuit Diagram**

Notes for Figure 11:

1. Drawings are not to scale.
2. Drawing dimensions are in millimeters.
3. Unless otherwise specified, tolerances are  $\pm 0.10\text{mm}$ .

## Recommended PCB Soldering Pad Pattern

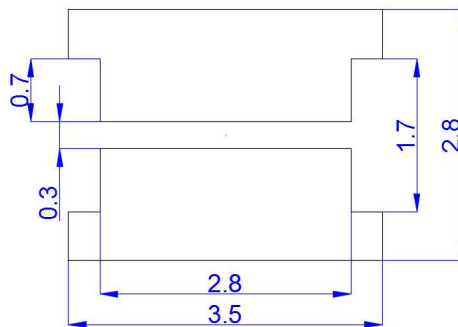

# Reliability

**Table 10: Reliability Test Items and Conditions**

No.	Items	Reference Standard	Test Conditions	Drive Current	Test Duration	Units Failed/Tested
1	Moisture/Reflow Sensitivity	J-STD-020E	$T_{\text{std}} = 260^{\circ}\text{C}$ , 10sec. Precondition: $60^{\circ}\text{C}$ , 60%RH, 168hr	-	3 reflows	0/20
2	Low Temperature Storage	JESD22-A119	$T_{\text{a}} = -40^{\circ}\text{C}$	-	1000 hours	0/20
3	High Temperature Storage	JESD22-A103D	$T_{\text{a}} = 105^{\circ}\text{C}$	-	1000 hours	0/20
4	Low Temperature Operating Life	JESD22-A108D	$T_{\text{a}} = -40^{\circ}\text{C}$	65mA	1000 hours	0/20
5	Temperature Humidity Operating Life	JESD22-A101C	$T_{\text{sp}} = 85^{\circ}\text{C}$ , RH=85%	65mA	1000 hours	0/20
6	High Temperature Operating Life	JESD22-A108D	$T_{\text{sp}} = 85^{\circ}\text{C}$	350mA	1000 hours	0/20
7	Power switching	IEC62717:2014	$T_{\text{sp}} = 85^{\circ}\text{C}$ 30 sec on, 30 sec off	350mA	30000 cycles	0/20
8	Thermal Shock	JESD22-A106B	$T_{\text{a}} = -40^{\circ}\text{C} \sim 105^{\circ}\text{C}$ ; Dwell: 15min; Transfer: 10sec	-	200 cycles	0/20
9	Temperature Cycle	JESD22-A104E	$T_{\text{a}} = -40^{\circ}\text{C} \sim 100^{\circ}\text{C}$ ; Dwell at extreme temperature: 15min; Ramp rate < $105^{\circ}\text{C}/\text{min}$	-	200 cycles	0/20
10	Electrostatic Discharge	JS-001-2012	HBM, 8KV, 15k $\Omega$ , 100pF, Alternately positive or negative	-	-	0/20

## Passing Criteria

Item	Symbol	Test Condition	Passing Criteria
Forward Voltage	Vf	65mA	$\Delta V_f < 10\%$
Luminous Flux	Fv	65mA	$\Delta F_v < 30\%$
Chromaticity Coordinates	(x, y)	65mA	$\Delta u'v' < 0.007$

Notes for Table 10:

- Measurements are performed after allowing the LEDs to return to room temperature
- $T_{\text{std}}$ : reflow soldering temperature;  $T_{\text{a}}$ : ambient temperature

# Reflow Characteristics

Figure 12 : Reflow Profile

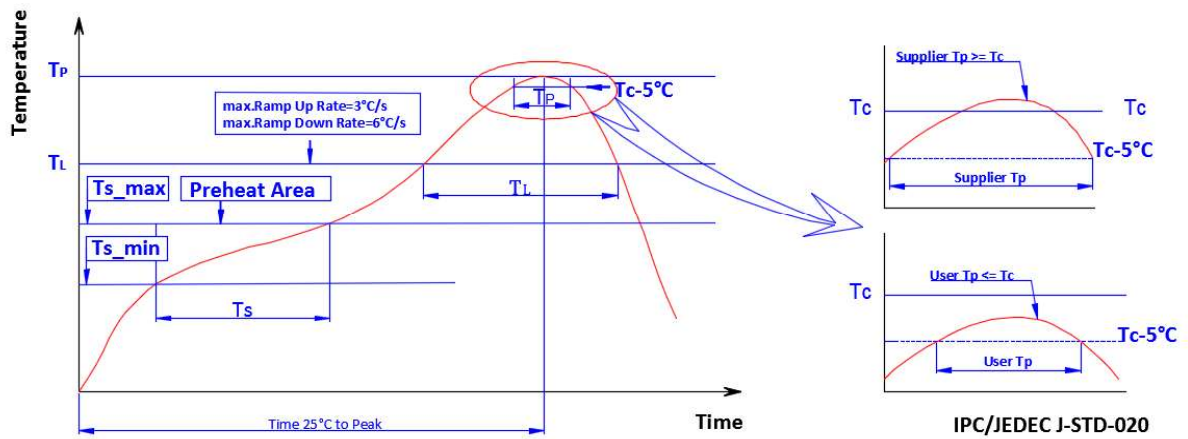

Profile Feature	Lead Free Assembly
Temperature Min. (Ts_min)	160°C
Temperature Max. (Ts_max)	205°C
Time (ts) from Ts_min to Ts_max	60-150 seconds
Ramp-Up Rate (TL to Tp)	3 °C/second
Liquidus Temperature (TL)	220 °C
Time (TL) Maintained Above TL	60-150 seconds
Peak Temp( Tp)	260 °C max.
Time (Tp) Within 5 °C of the Specified Classification Temperature (Tc)	25 seconds max.
Ramp-Down Rate (Tp to TL)	5 °C/second max.
Time 25 °C to Peak Temperature	10 minutes max.

# Packaging

**Figure 13: Emitter Reel Drawings**

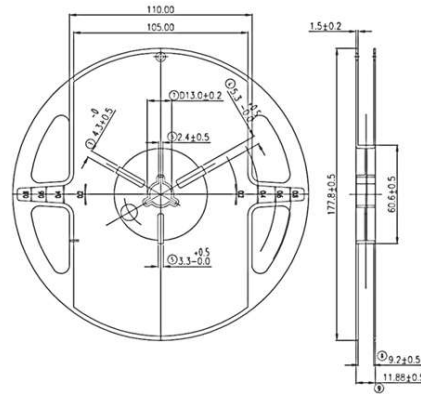

Note for Figure 13:

1. Drawings are not to scale. Drawing dimensions are in millimeters.

**Figure 14: Emitter Tape Drawings**

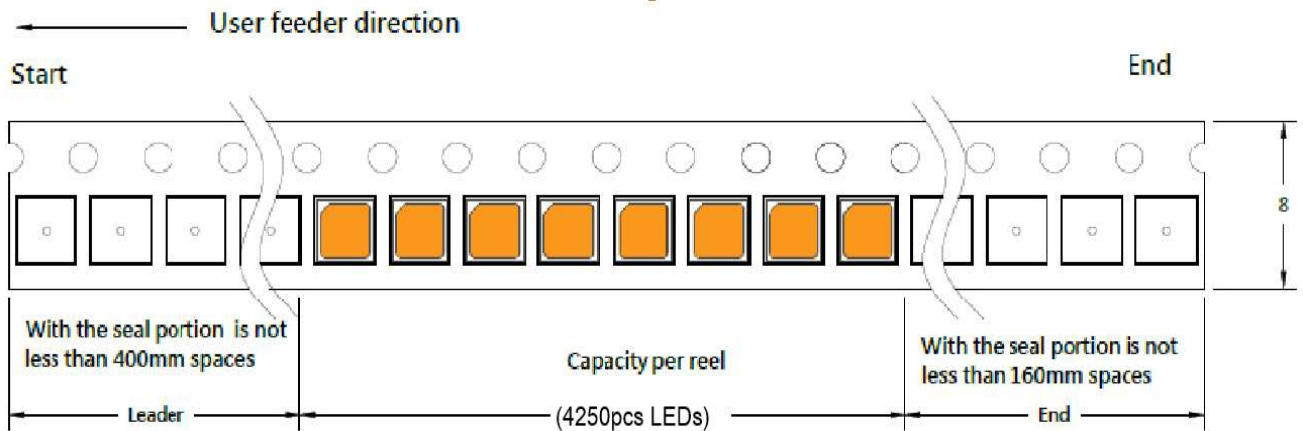

Note for Figure 14:

1. Drawings are not to scale. Drawing dimensions are in millimeters.

# Packaging

**Figure 15: Emitter Reel Packaging Drawings**

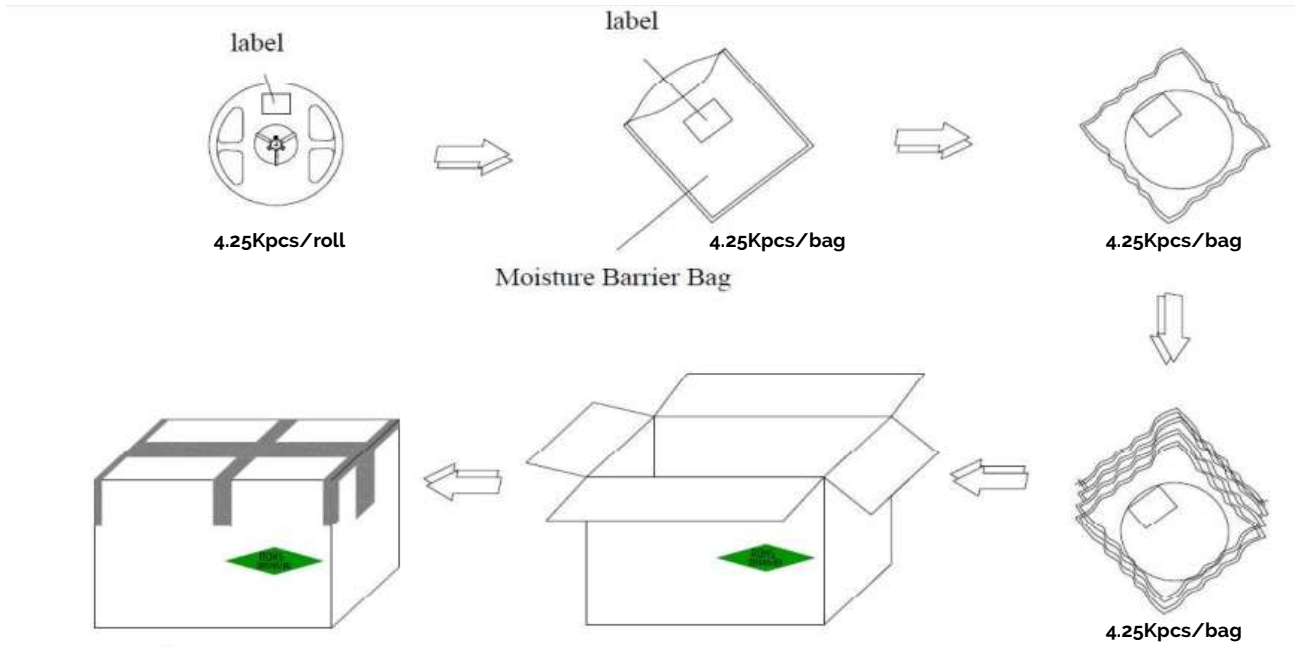

Packing Categories	Packing List	LED Q'ty
Small cardboard Box	6 bags	25,5Kpcs
Medium cardboard Box	5 small boxes	127,5Kpcs
Large cardboard Box	10 small boxes	255Kpcs

Note for Figure 15:  
1. Drawings are not to scale.

# Design Resources

Please contact your Bridgelux sales representative for assistance.

## Precautions

### **CAUTION: CHEMICAL EXPOSURE HAZARD**

Exposure to some chemicals commonly used in luminaire manufacturing and assembly can cause damage to the LED emitter. Please consult Bridgelux Application Note AN51 for additional information.

### **CAUTION: EYE SAFETY**

Eye safety classification for the use of Bridgelux SMD LED emitter is in accordance with IEC specification EN62471: Photobiological Safety of Lamps and Lamp Systems. SMD LED emitters are classified as Risk Group 1 when operated at or below the maximum drive current. Please use appropriate precautions. It is important that employees working with LEDs are trained to use them safely.

### **CAUTION: RISK OF BURN**

Do not touch the SMD LED emitter during operation. Allow the emitter to cool for a sufficient period of time before handling. The SMD LED emitter may reach elevated temperatures such that could burn skin when touched.

## CAUTION

### **CONTACT WITH LIGHT EMITTING SURFACE (LES)**

Avoid any contact with the LES. Do not touch the LES of the emitter or apply stress to the LES (yellow phosphor resin area). Contact may cause damage to the emitter

Optics and reflectors must not be mounted in contact with the LES (yellow phosphor resin area).

## Disclaimers

### **MINOR PRODUCT CHANGE POLICY**

The rigorous qualification testing on products offered by Bridgelux provides performance assurance. Slight cosmetic changes that do not affect form, fit, or function may occur as Bridgelux continues product optimization.

### **STANDARD TEST CONDITIONS**

Unless otherwise stated, LED emitter testing is performed at the nominal drive current.

# About Bridgelux: Bridging Light and Life™

At Bridgelux, we help companies, industries and people experience the power and possibility of light. Since 2002, we've designed LED solutions that are high performing, energy efficient, cost effective and easy to integrate. Our focus is on light's impact on human behavior, delivering products that create better environments, experiences and returns—both experiential and financial. And our patented technology drives new platforms for commercial and industrial luminaires.

**For more information about the company, please visit**  
**bridgelux.com**  
**twitter.com/Bridgelux**  
**facebook.com/Bridgelux**  
**youtube.com/user/Bridgelux**  
**WeChat ID: BridgeluxInChina**  
**[https://www.linkedin.com/company/bridgelux-inc-\\_2](https://www.linkedin.com/company/bridgelux-inc-_2)**



46410 Fremont Boulevard  
Fremont, CA 94538 USA  
Tel (925) 583-8400  
Fax (925) 583-8401  
**[www.bridgelux.com](http://www.bridgelux.com)**

© 2025 Bridgelux, Inc. All rights reserved 2023. Product specifications are subject to change without notice. Bridgelux and the Bridgelux stylized logo design are registered trademarks of Bridgelux, Inc. All other trademarks are the property of their respective owners.