

Bridgelux® CSP 2424 Series

Product Data Sheet DS962

Introduction

CSP 2424

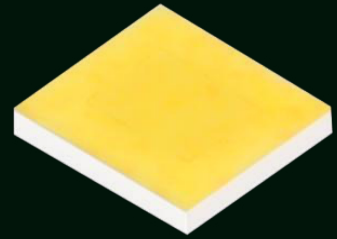

The Bridgelux Chip Scale Package (CSP) 2424 LED offers exceptional performance in an ultra compact size. This CSP LED is hot-color targeted which ensures that the LEDs fall within their specified color bin at the typical application conditions of 85°C. With its superior performance without bonding wires and ability to assemble a densely populated and high luminous flux LED board, the CSP 2424 provides unparalleled design-in flexibility for indoor and outdoor lighting applications. The CSP 2424 is ideal as a drop in replacement for emitters with an industry standard 2.4mm x 2.4mm footprint.

Features

- Competitive efficacy and lumen per dollar
- Industry-standard 2424 footprint, 1-sided emitter
- Excellent color maintenance
- Compatible with SMT
- Superior luminous flux at maximum current for reduced LED count
- Hot-color targeting ensures that color is within the ANSI bin at the typical application conditions of 85°C
- Enables 3- and 5-step MacAdam ellipse custom binning kits
- 120 degrees viewing angle
- Multiple CCT and CRI configurations for a wide range of lighting applications

Benefits

- Lower operating and manufacturing cost
- Ease of design and rapid go-to-market
- Uniform consistent white light
- Reliable and constant white point
- Environmentally friendly, complies with standards
- Design flexibility

Contents

Product Feature Map	2
Product Nomenclature	2
Product Test Conditions	2
Product Selection Guide	3
Performance at Commonly Used Drive Currents	5
Electrical and Thermal Characteristics	11
Absolute Maximum Ratings	12
Product Bin Definitions	13
Performance Curves	16
Typical Radiation Pattern	19
Typical Color Spectrum	20
Mechanical Dimensions	21
Reliability	22
Reflowing Characteristics	23
Packaging	24
Design Resources	26
Precautions	26
Disclaimers	26
About Bridgelux	27

Product Feature Map

Bridgelux CSP LED products offer exceptional performance and color quality all in a highly reliable, cost effective, compact package. Our CSP products come in industry standard package sizes and follow ANSI binning standards.

These LEDs are optimized for cost and performance, helping to ensure highly competitive system lumen per dollar performance while addressing the stringent efficacy and reliability standards required for modern lighting applications.

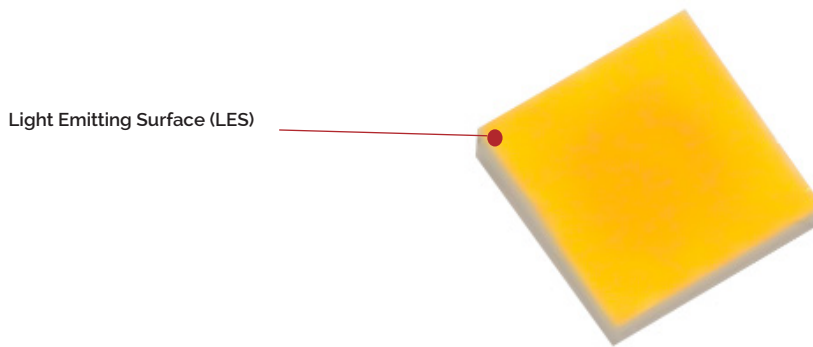

Product Nomenclature

The part number designation for Bridgelux CSP 2424 is explained as follows:

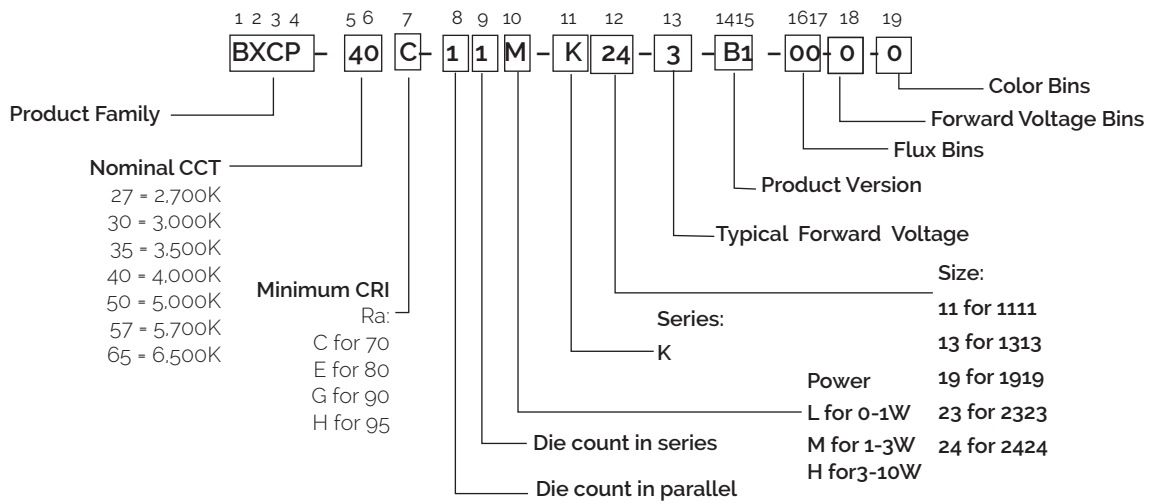

Product Test Conditions

Bridgelux CSP 2424 LEDs are tested and binned with a 10ms pulse of 700mA at T_j (junction temperature) = T_{sp} (solder point temperature) = 85°C. Luminous flux, color and forward voltage are binned at $T_j = T_{sp} = 85^\circ\text{C}$.

Product Selection Guide

The following product configurations are available:

Table 1: Selection Guide, Pulsed Measurement Data at 700mA ($T_j = T_{sp} = 25^\circ\text{C}$)

Part Number ^{1,6}	Nominal CCT ² (K)	CRI ^{3,5}	Nominal Drive Current (mA)	Forward Voltage ^{4,5} (V)			Typical Pulsed Flux ^{4,5} (lm)	Typical Power (W)	Typical Efficacy (lm/W)
				Min	Typical	Max			
BXCP-22C-11M-K24-3-B1-00-0-0	2200	70	700	2.80	3.00	3.30	304	2.1	145
BXCP-27C-11M-K24-3-B1-00-0-0	2700	70	700	2.80	3.00	3.30	353	2.1	168
BXCP-30C-11M-K24-3-B1-00-0-0	3000	70	700	2.80	3.00	3.30	370	2.1	176
BXCP-40C-11M-K24-3-B1-00-0-0	4000	70	700	2.80	3.00	3.30	390	2.1	186
BXCP-50C-11M-K24-3-B1-00-0-0	5000	70	700	2.80	3.00	3.30	390	2.1	186
BXCP-57C-11M-K24-3-B1-00-0-0	5700	70	700	2.80	3.00	3.30	390	2.1	186
BXCP-65C-11M-K24-3-B1-00-0-0	6500	70	700	2.80	3.00	3.30	386	2.1	184
BXCP-18E-11M-K24-3-B1-00-0-0	1800	80	700	2.80	3.00	3.30	228	2.1	109
BXCP-22E-11M-K24-3-B1-00-0-0	2200	80	700	2.80	3.00	3.30	261	2.1	124
BXCP-27E-11M-K24-3-B1-00-0-0	2700	80	700	2.80	3.00	3.30	314	2.1	150
BXCP-30E-11M-K24-3-B1-00-0-0	3000	80	700	2.80	3.00	3.30	330	2.1	157
BXCP-35E-11M-K24-3-B1-00-0-0	3500	80	700	2.80	3.00	3.30	330	2.1	157
BXCP-40E-11M-K24-3-B1-00-0-0	4000	80	700	2.80	3.00	3.30	353	2.1	168
BXCP-50E-11M-K24-3-B1-00-0-0	5000	80	700	2.80	3.00	3.30	353	2.1	168
BXCP-57E-11M-K24-3-B1-00-0-0	5700	80	700	2.80	3.00	3.30	353	2.1	168
BXCP-65E-11M-K24-3-B1-00-0-0	6500	80	700	2.80	3.00	3.30	342	2.1	163
BXCP-18G-11M-K24-3-B1-00-0-0	1800	90	700	2.80	3.00	3.30	194	2.1	92
BXCP-22G-11M-K24-3-B1-00-0-0	2200	90	700	2.80	3.00	3.30	222	2.1	106
BXCP-27G-11M-K24-3-B1-00-0-0	2700	90	700	2.80	3.00	3.30	267	2.1	127
BXCP-30G-11M-K24-3-B1-00-0-0	3000	90	700	2.80	3.00	3.30	284	2.1	135
BXCP-35G-11M-K24-3-B1-00-0-0	3500	90	700	2.80	3.00	3.30	291	2.1	139
BXCP-40G-11M-K24-3-B1-00-0-0	4000	90	700	2.80	3.00	3.30	306	2.1	146
BXCP-50G-11M-K24-3-B1-00-0-0	5000	90	700	2.80	3.00	3.30	306	2.1	146
BXCP-57G-11M-K24-3-B1-00-0-0	5700	90	700	2.80	3.00	3.30	306	2.1	146
BXCP-65G-11M-K24-3-B1-00-0-0	6500	90	700	2.80	3.00	3.30	300	2.1	143
BXCP-18H-11M-K24-3-B1-00-0-0	1800	95	700	2.80	3.00	3.30	167	2.1	79
BXCP-22H-11M-K24-3-B1-00-0-0	2200	95	700	2.80	3.00	3.30	187	2.1	89
BXCP-27H-11M-K24-3-B1-00-0-0	2700	95	700	2.80	3.00	3.30	222	2.1	106
BXCP-30H-11M-K24-3-B1-00-0-0	3000	95	700	2.80	3.00	3.30	239	2.1	114
BXCP-35H-11M-K24-3-B1-00-0-0	3500	95	700	2.80	3.00	3.30	244	2.1	116
BXCP-40H-11M-K24-3-B1-00-0-0	4000	95	700	2.80	3.00	3.30	272	2.1	130
BXCP-50H-11M-K24-3-B1-00-0-0	5000	95	700	2.80	3.00	3.30	278	2.1	132
BXCP-57H-11M-K24-3-B1-00-0-0	5700	95	700	2.80	3.00	3.30	278	2.1	132
BXCP-65H-11M-K24-3-B1-00-0-0	6500	95	700	2.80	3.00	3.30	278	2.1	132

Notes for Table 1:

- The last 6 characters (including hyphens '-') refer to nominal flux, nominal forward voltage, and color bins, respectively. "00-0-0" denotes the full distribution of flux, forward voltage, and 5 SDCM color.
Example: BXCP-40C-11M-K24-3-B1-00-0-0 refers to the full distribution of flux, forward voltage, and color within a 4000K 5-step ANSI standard chromaticity region with a minimum of 70 CRI.
- Product CCT is hot targeted at $T_{sp} = 85^\circ\text{C}$. Nominal CCT as defined by ANSI C78.377-2011.
- Listed CRIs are minimum values and include test tolerance.
- Products tested under pulsed condition (10ms pulse width) at nominal drive current where $T_j = T_{sp} = 25^\circ\text{C}$.
- Bridgelux maintains a $\pm 7.5\%$ tolerance on luminous flux measurements, $\pm 0.1\text{V}$ tolerance on forward voltage measurements, and ± 2 tolerance on CRI measurements for the CSP.
- Refer to Table 6 and Table 7 for Bridgelux CSP Luminous Flux Binning and Forward Voltage Binning information.

Product Selection Guide

Table 2: Selection Guide, Pulsed Measurement Data at 700mA ($T_j = T_{sp} = 85^\circ\text{C}$)

Part Number ^{1,5}	Nominal CCT ² (K)	CRI ^{3,4}	Nominal Drive Current (mA)	Forward Voltage ⁴ (V)			Typical Pulsed Flux ⁴ (lm)	Typical Power (W)	Typical Efficacy (lm/W)
				Min	Typical	Max			
BXCP-22C-11M-K24-3-B1-00-0-0	2700	70	700	2.70	2.90	3.20	280	2.0	138
BXCP-27C-11M-K24-3-B1-00-0-0	2700	70	700	2.70	2.90	3.20	324	2.0	160
BXCP-30C-11M-K24-3-B1-00-0-0	3000	70	700	2.70	2.90	3.20	341	2.0	168
BXCP-40C-11M-K24-3-B1-00-0-0	4000	70	700	2.70	2.90	3.20	359	2.0	177
BXCP-50C-11M-K24-3-B1-00-0-0	5000	70	700	2.70	2.90	3.20	359	2.0	177
BXCP-57C-11M-K24-3-B1-00-0-0	5700	70	700	2.70	2.90	3.20	359	2.0	177
BXCP-65C-11M-K24-3-B1-00-0-0	6500	70	700	2.70	2.90	3.20	355	2.0	175
BXCP-18E-11M-K24-3-B1-00-0-0	2700	80	700	2.70	2.90	3.20	210	2.0	103
BXCP-22E-11M-K24-3-B1-00-0-0	3000	80	700	2.70	2.90	3.20	240	2.0	118
BXCP-27E-11M-K24-3-B1-00-0-0	2700	80	700	2.70	2.90	3.20	288	2.0	142
BXCP-30E-11M-K24-3-B1-00-0-0	3000	80	700	2.70	2.90	3.20	304	2.0	150
BXCP-35E-11M-K24-3-B1-00-0-0	3000	80	700	2.70	2.90	3.20	304	2.0	150
BXCP-40E-11M-K24-3-B1-00-0-0	4000	80	700	2.70	2.90	3.20	325	2.0	160
BXCP-50E-11M-K24-3-B1-00-0-0	5000	80	700	2.70	2.90	3.20	325	2.0	160
BXCP-57E-11M-K24-3-B1-00-0-0	5700	80	700	2.70	2.90	3.20	325	2.0	160
BXCP-65E-11M-K24-3-B1-00-0-0	6500	80	700	2.70	2.90	3.20	315	2.0	155
BXCP-18G-11M-K24-3-B1-00-0-0	1800	90	700	2.70	2.90	3.20	175	2.0	86
BXCP-22G-11M-K24-3-B1-00-0-0	2200	90	700	2.70	2.90	3.20	200	2.0	99
BXCP-27G-11M-K24-3-B1-00-0-0	2700	90	700	2.70	2.90	3.20	246	2.0	121
BXCP-30G-11M-K24-3-B1-00-0-0	3000	90	700	2.70	2.90	3.20	257	2.0	127
BXCP-35G-11M-K24-3-B1-00-0-0	3000	90	700	2.70	2.90	3.20	262	2.0	129
BXCP-40G-11M-K24-3-B1-00-0-0	4000	90	700	2.70	2.90	3.20	275	2.0	135
BXCP-50G-11M-K24-3-B1-00-0-0	5000	90	700	2.70	2.90	3.20	275	2.0	135
BXCP-57G-11M-K24-3-B1-00-0-0	5700	90	700	2.70	2.90	3.20	275	2.0	135
BXCP-65G-11M-K24-3-B1-00-0-0	6500	90	700	2.70	2.90	3.20	270	2.0	133
BXCP-18H-11M-K24-3-B1-00-0-0	1800	95	700	2.70	2.90	3.20	150	2.0	74
BXCP-22H-11M-K24-3-B1-00-0-0	2200	95	700	2.70	2.90	3.20	168	2.0	83
BXCP-27H-11M-K24-3-B1-00-0-0	2700	95	700	2.70	2.90	3.20	200	2.0	99
BXCP-30H-11M-K24-3-B1-00-0-0	3000	95	700	2.70	2.90	3.20	215	2.0	106
BXCP-35H-11M-K24-3-B1-00-0-0	3500	95	700	2.70	2.90	3.20	220	2.0	108
BXCP-40H-11M-K24-3-B1-00-0-0	4000	95	700	2.70	2.90	3.20	245	2.0	121
BXCP-50H-11M-K24-3-B1-00-0-0	5000	95	700	2.70	2.90	3.20	250	2.0	123
BXCP-57H-11M-K24-3-B1-00-0-0	5700	95	700	2.70	2.90	3.20	250	2.0	123
BXCP-65H-11M-K24-3-B1-00-0-0	6500	95	700	2.70	2.90	3.20	250	2.0	123

Notes for Table 2:

- The last 6 characters (including hyphens '-') refer to nominal flux, nominal forward voltage, and color bins, respectively. "00-0-0" denotes the full distribution of flux, forward voltage, and 5 SDCM color.
Example: BXCP-40C-11M-K24-3-B1-00-0-0 refers to the full distribution of flux, forward voltage, and color within a 4000K 5-step ANSI standard chromaticity region with a minimum of 70 CRI.
- Product CCT is hot targeted at $T_{sp} = 85^\circ\text{C}$. Nominal CCT as defined by ANSI C78.377-2011.
- Listed CRIs are minimum values and include test tolerance.
- Bridgelux maintains a $\pm 7.5\%$ tolerance on luminous flux measurements, $\pm 0.1\text{V}$ tolerance on forward voltage measurements, and ± 2 tolerance on CRI measurements for the CSP.
- Refer to Table 6 and Table 7 for Bridgelux CSP Luminous Flux Binning and Forward Voltage Binning information.
- Products tested under pulsed condition (10ms pulse width) at nominal drive current where $T_j = T_{sp} = 85^\circ\text{C}$.

Performance at Commonly Used Drive Currents

CSP 2424 LEDs specifications at nominal drive current are shown in Table 1 and Table 2. CSP 2424 may also be driven at other drive currents dependent on specific application design requirements. The performance at any drive current can be derived from the current vs. voltage characteristics shown in Figure 2 and the relative luminous flux vs. current characteristics shown in Figure 3. The performance at commonly used drive currents is summarized in Table 3.

Table 3: Performance at Commonly Used Drive Currents

Part Number	CRI	Drive Current ¹ (mA)	Typical V_f $T_{sp} = 25^\circ\text{C}$ (V)	Typical Power $T_{sp} = 25^\circ\text{C}$ (W)	Typical Pulsed Flux ² $T_{sp} = 25^\circ\text{C}$ (lm)	Typical Pulsed Flux ³ $T_{sp} = 85^\circ\text{C}$ (lm)	Typical Efficacy $T_{sp} = 25^\circ\text{C}$ (lm/W)
BXCP-22C-11M-K24-3-B1-00-0-0	70	50	2.6	0.1	25	23	191
		200	2.7	0.5	97	90	178
		350	2.9	1.0	165	152	165
		700	3.0	2.1	304	280	145
		1000	3.2	3.2	412	379	131
		1400	3.3	4.7	539	496	115
BXCP-27C-11M-K24-3-B1-00-0-0	70	50	2.6	0.1	29	27	221
		200	2.7	0.5	113	104	206
		350	2.9	1.0	191	176	192
		700	3.0	2.1	353	324	168
		1000	3.2	3.2	478	439	151
		1400	3.3	4.7	625	575	134
BXCP-30C-11M-K24-3-B1-00-0-0	70	50	2.6	0.1	31	28	232
		200	2.7	0.5	119	109	216
		350	2.9	1.0	200	185	201
		700	3.0	2.1	370	341	176
		1000	3.2	3.2	502	462	159
		1400	3.3	4.7	657	605	141
BXCP-40C-11M-K24-3-B1-00-0-0	70	50	2.6	0.1	32	30	245
		200	2.7	0.5	125	115	228
		350	2.9	1.0	211	195	212
		700	3.0	2.1	390	359	185
		1000	3.2	3.2	529	486	168
		1400	3.3	4.7	692	637	148
BXCP-50C-11M-K24-3-B1-00-0-0	70	50	2.6	0.1	32	30	245
		200	2.7	0.5	125	115	228
		350	2.9	1.0	211	195	212
		700	3.0	2.1	390	359	185
		1000	3.2	3.2	529	486	168
		1400	3.3	4.7	692	637	148
BXCP-57C-11M-K24-3-B1-00-0-0	70	50	2.6	0.1	32	30	245
		200	2.7	0.5	125	115	228
		350	2.9	1.0	211	195	212
		700	3.0	2.1	390	359	185
		1000	3.2	3.2	529	486	168
		1400	3.3	4.7	692	637	148

Notes for Table 3:

1. Alternate drive currents in Table 3 are provided for reference only and are not a guarantee of performance.
2. Bridgelux maintains a $\pm 7.5\%$ tolerance on flux measurements.
3. Typical pulsed performance values are provided as reference only and are not a guarantee of performance.

Performance at Commonly Used Drive Currents

Table 3: Performance at Commonly Used Drive Currents (Continued)

Part Number	CRI	Drive Current ¹ (mA)	Typical V_f $T_{sp} = 25^\circ\text{C}$ (V)	Typical Power $T_{sp} = 25^\circ\text{C}$ (W)	Typical Pulsed Flux ² $T_{sp} = 25^\circ\text{C}$ (lm)	Typical Pulsed Flux ³ $T_{sp} = 85^\circ\text{C}$ (lm)	Typical Efficacy $T_{sp} = 25^\circ\text{C}$ (lm/W)
BXCP-65C-11M-K24-3-B1-00-0-0	70	50	2.6	0.1	32	29	243
		200	2.7	0.5	124	114	226
		350	2.9	1.0	209	193	210
		700	3.0	2.1	386	355	183
		1000	3.2	3.2	524	481	166
		1400	3.3	4.7	686	630	147
BXCP-18E-11M-K24-3-B1-00-0-0	80	50	2.6	0.1	19	17	143
		200	2.7	0.5	73	67	133
		350	2.9	1.0	124	114	124
		700	3.0	2.1	228	210	108
		1000	3.2	3.2	309	284	98
		1400	3.3	4.7	404	372	87
BXCP-22E-11M-K24-3-B1-00-0-0	80	50	2.6	0.1	21	20	164
		200	2.7	0.5	83	77	152
		350	2.9	1.0	141	130	142
		700	3.0	2.1	261	240	124
		1000	3.2	3.2	353	325	112
		1400	3.3	4.7	462	425	99
BXCP-27E-11M-K24-3-B1-00-0-0	80	50	2.6	0.1	26	24	196
		200	2.7	0.5	100	92	183
		350	2.9	1.0	170	156	170
		700	3.0	2.1	314	288	149
		1000	3.2	3.2	424	390	134
		1400	3.3	4.7	555	511	119
BXCP-30E-11M-K24-3-B1-00-0-0	80	50	2.6	0.1	27	25	207
		200	2.7	0.5	106	97	193
		350	2.9	1.0	179	165	179
		700	3.0	2.1	330	304	157
		1000	3.2	3.2	447	411	142
		1400	3.3	4.7	585	538	125
BXCP-35E-11M-K24-3-B1-00-0-0	80	50	2.6	0.1	27	25	207
		200	2.7	0.5	106	97	193
		350	2.9	1.0	179	164	179
		700	3.0	2.1	330	304	157
		1000	3.2	3.2	447	411	142
		1400	3.3	4.7	585	538	125

Notes for Table 3:

1. Alternate drive currents in Table 3 are provided for reference only and are not a guarantee of performance.
2. Bridgelux maintains a $\pm 7.5\%$ tolerance on flux measurements.
3. Typical pulsed performance values are provided as reference only and are not a guarantee of performance.

Performance at Commonly Used Drive Currents

Table 3: Performance at Commonly Used Drive Currents (Continued)

Part Number	CRI	Drive Current ¹ (mA)	Typical V_f $T_{sp} = 25^\circ\text{C}$ (V)	Typical Power $T_{sp} = 25^\circ\text{C}$ (W)	Typical Pulsed Flux ² $T_{sp} = 25^\circ\text{C}$ (lm)	Typical Pulsed Flux ³ $T_{sp} = 85^\circ\text{C}$ (lm)	Typical Efficacy $T_{sp} = 25^\circ\text{C}$ (lm/W)
BXCP-40E-11M-K24-3-B1-00-0-0	80	50	2.6	0.1	29	27	221
		200	2.7	0.5	113	104	206
		350	2.9	1.0	191	176	192
		700	3.0	2.1	353	325	168
		1000	3.2	3.2	478	440	152
		1400	3.3	4.7	626	576	134
BXCP-50E-11M-K24-3-B1-00-0-0	80	50	2.6	0.1	29	27	221
		200	2.7	0.5	113	104	206
		350	2.9	1.0	191	176	192
		700	3.0	2.1	353	325	168
		1000	3.2	3.2	478	440	152
		1400	3.3	4.7	626	576	134
BXCP-57E-11M-K24-3-B1-00-0-0	80	50	2.6	0.1	29	27	221
		200	2.7	0.5	113	104	206
		350	2.9	1.0	191	176	192
		700	3.0	2.1	353	325	168
		1000	3.2	3.2	478	440	152
		1400	3.3	4.7	626	576	134
BXCP-65E-11M-K24-3-B1-00-0-0	80	50	2.6	0.1	28	26	215
		200	2.7	0.5	110	101	200
		350	2.9	1.0	185	171	186
		700	3.0	2.1	342	315	163
		1000	3.2	3.2	463	426	147
		1400	3.3	4.7	606	558	130
BXCP-18G-11M-K24-3-B1-00-0-0	90	50	2.6	0.1	16	14	122
		200	2.7	0.5	62	56	113
		350	2.9	1.0	105	95	106
		700	3.0	2.1	194	175	92
		1000	3.2	3.2	263	237	83
		1400	3.3	4.7	344	310	74
BXCP-22G-11M-K24-3-B1-00-0-0	90	50	2.6	0.1	18	16	139
		200	2.7	0.5	71	64	130
		350	2.9	1.0	120	108	121
		700	3.0	2.1	222	200	106
		1000	3.2	3.2	301	271	95
		1400	3.3	4.7	394	354	84

Notes for Table 3:

1. Alternate drive currents in Table 3 are provided for reference only and are not a guarantee of performance.
2. Bridgelux maintains a $\pm 7.5\%$ tolerance on flux measurements.
3. Typical pulsed performance values are provided as reference only and are not a guarantee of performance.

Performance at Commonly Used Drive Currents

Table 3: Performance at Commonly Used Drive Currents (Continued)

Part Number	CRI	Drive Current ¹ (mA)	Typical V_f $T_{sp} = 25^\circ\text{C}$ (V)	Typical Power $T_{sp} = 25^\circ\text{C}$ (W)	Typical Pulsed Flux ² $T_{sp} = 25^\circ\text{C}$ (lm)	Typical Pulsed Flux ³ $T_{sp} = 85^\circ\text{C}$ (lm)	Typical Efficacy $T_{sp} = 25^\circ\text{C}$ (lm/W)
BXCP-27G-11M-K24-3-B1-00-0-0	90	50	2.6	0.1	22	20	168
		200	2.7	0.5	86	79	156
		350	2.9	1.0	145	134	146
		700	3.0	2.1	267	246	127
		1000	3.2	3.2	363	334	115
		1400	3.3	4.7	475	437	102
BXCP-30G-11M-K24-3-B1-00-0-0	90	50	2.6	0.1	23	21	179
		200	2.7	0.5	91	82	167
		350	2.9	1.0	155	139	155
		700	3.0	2.1	284	257	135
		1000	3.2	3.2	386	348	122
		1400	3.3	4.7	506	455	108
BXCP-35G-11M-K24-3-B1-00-0-0	90	50	2.6	0.1	24	22	182
		200	2.7	0.5	93	84	170
		350	2.9	1.0	158	142	158
		700	3.0	2.1	291	262	139
		1000	3.2	3.2	394	355	125
		1400	3.3	4.7	516	464	110
BXCP-40G-11M-K24-3-B1-00-0-0	90	50	2.6	0.1	25	23	192
		200	2.7	0.5	98	88	178
		350	2.9	1.0	165	149	166
		700	3.0	2.1	306	275	146
		1000	3.2	3.2	413	372	131
		1400	3.3	4.7	541	487	116
BXCP-50G-11M-K24-3-B1-00-0-0	90	50	2.6	0.1	25	23	192
		200	2.7	0.5	98	88	178
		350	2.9	1.0	165	149	166
		700	3.0	2.1	306	275	146
		1000	3.2	3.2	413	372	131
		1400	3.3	4.7	541	487	116
BXCP-57G-11M-K24-3-B1-00-0-0	90	50	2.6	0.1	25	23	192
		200	2.7	0.5	98	88	178
		350	2.9	1.0	165	149	166
		700	3.0	2.1	306	275	146
		1000	3.2	3.2	413	372	131
		1400	3.3	4.7	541	487	116

Notes for Table 3:

1. Alternate drive currents in Table 3 are provided for reference only and are not a guarantee of performance.
2. Bridgelux maintains a $\pm 7.5\%$ tolerance on flux measurements.
3. Typical pulsed performance values are provided as reference only and are not a guarantee of performance.

Performance at Commonly Used Drive Currents

Table 3: Performance at Commonly Used Drive Currents (Continued)

Part Number	CRI	Drive Current ¹ (mA)	Typical V _f T _{sp} = 25° C (V)	Typical Power T _{sp} = 25° C (W)	Typical Pulsed Flux ² T _{sp} = 25° C (lm)	Typical Pulsed Flux ³ T _{sp} = 85° C (lm)	Typical Efficacy T _{sp} = 25° C (lm/W)
BXCP-65G-11M-K24-3-B1-00-0-0	90	50	2.6	0.1	25	22	188
		200	2.7	0.5	96	86	175
		350	2.9	1.0	162	146	163
		700	3.0	2.1	300	270	143
		1000	3.2	3.2	406	365	129
		1400	3.3	4.7	531	478	114
BXCP-18H-11M-K24-3-B1-00-0-0	95	50	2.6	0.1	14	12	104
		200	2.7	0.5	53	48	97
		350	2.9	1.0	90	81	90
		700	3.0	2.1	167	150	79
		1000	3.2	3.2	226	203	71
		1400	3.3	4.7	295	266	63
BXCP-22H-11M-K24-3-B1-00-0-0	95	50	2.6	0.1	15	14	117
		200	2.7	0.5	60	54	109
		350	2.9	1.0	101	91	101
		700	3.0	2.1	187	168	89
		1000	3.2	3.2	253	227	80
		1400	3.3	4.7	331	298	71
BXCP-27H-11M-K24-3-B1-00-0-0	95	50	2.6	0.1	18	16	139
		200	2.7	0.5	71	64	130
		350	2.9	1.0	120	108	121
		700	3.0	2.1	222	200	106
		1000	3.2	3.2	301	271	95
		1400	3.3	4.7	394	354	84
BXCP-30H-11M-K24-3-B1-00-0-0	95	50	2.6	0.1	20	18	150
		200	2.7	0.5	76	69	139
		350	2.9	1.0	129	116	130
		700	3.0	2.1	239	215	114
		1000	3.2	3.2	323	291	102
		1400	3.3	4.7	423	381	91
BXCP-35H-11M-K24-3-B1-00-0-0	95	50	2.6	0.1	20	18	153
		200	2.7	0.5	78	70	143
		350	2.9	1.0	132	119	133
		700	3.0	2.1	244	220	116
		1000	3.2	3.2	331	298	105
		1400	3.3	4.7	433	390	93

Notes for Table 3:

1. Alternate drive currents in Table 3 are provided for reference only and are not a guarantee of performance.
2. Bridgelux maintains a ± 7.5% tolerance on flux measurements.
3. Typical pulsed performance values are provided as reference only and are not a guarantee of performance.

Performance at Commonly Used Drive Currents

Table 3: Performance at Commonly Used Drive Currents (Continued)

Part Number	CRI	Drive Current ¹ (mA)	Typical V_f $T_{sp} = 25^\circ\text{C}$ (V)	Typical Power $T_{sp} = 25^\circ\text{C}$ (W)	Typical Pulsed Flux ² $T_{sp} = 25^\circ\text{C}$ (lm)	Typical Pulsed Flux ³ $T_{sp} = 85^\circ\text{C}$ (lm)	Typical Efficacy $T_{sp} = 25^\circ\text{C}$ (lm/W)
BXCP-40H-11M-K24-3-B1-00-0-0	95	50	2.6	0.1	22	20	171
		200	2.7	0.5	87	78	159
		350	2.9	1.0	147	133	148
		700	3.0	2.1	272	245	130
		1000	3.2	3.2	368	332	117
		1400	3.3	4.7	482	434	103
BXCP-50H-11M-K24-3-B1-00-0-0	95	50	2.6	0.1	23	21	174
		200	2.7	0.5	89	80	162
		350	2.9	1.0	150	135	151
		700	3.0	2.1	278	250	132
		1000	3.2	3.2	376	338	119
		1400	3.3	4.7	492	443	105
BXCP-57H-11M-K24-3-B1-00-0-0	95	50	2.6	0.1	23	21	174
		200	2.7	0.5	89	80	162
		350	2.9	1.0	150	135	151
		700	3.0	2.1	278	250	132
		1000	3.2	3.2	376	338	119
		1400	3.3	4.7	492	443	105
BXCP-65H-11M-K24-3-B1-00-0-0	95	50	2.6	0.1	23	21	174
		200	2.7	0.5	89	80	162
		350	2.9	1.0	150	135	151
		700	3.0	2.1	278	250	132
		1000	3.2	3.2	376	338	119
		1400	3.3	4.7	492	443	105

Notes for Table 3:

1. Alternate drive currents in Table 3 are provided for reference only and are not a guarantee of performance.
2. Bridgelux maintains a $\pm 7.5\%$ tolerance on flux measurements.
3. Typical pulsed performance values are provided as reference only and are not a guarantee of performance.

Electrical and Thermal Characteristics

Table 4: Electrical and Thermal Characteristics

Part Number ¹	Drive Current (mA)	Forward Voltage ^{2,3} (V)			Typical Temperature Coefficient of Forward Voltage ⁴ $\Delta V_f / \Delta T$ (mV/°C)	Typical Thermal Resistance Junction to Solder Point ^{5,6} R_{j-sp} (°C/W)
		Minimum	Typical	Maximum		
BXCP-xxx-11M-K24-3-B1-00-0-0	700	2.70	2.90	3.20	-1.1	2.04

Notes for Table 4:

1. The last 6 characters (including hyphens '-') refer to nominal flux, nominal forward voltage, and color bins, respectively. "00-0-0" denotes the full distribution of flux, forward voltage, and 5 SDCM color.

Example: BXCP-40C-11M-K24-3-B1-00-0-0 refers to the full distribution of flux, forward voltage, and color within a 4000K 5-step ANSI standard chromaticity region with a minimum of 70 CRI.

2. Products tested under pulsed condition (10ms pulse width) where $T_{sp} = 85^{\circ}\text{C}$.

3. Bridgelux maintains a tolerance of $\pm 0.1\text{V}$ on forward voltage measurements.

4. Products measured between 25°C and 105°C under pulsed condition (10ms pulse width).

5. Thermal Resistance values based on 4000K 70 CRI product.

6. Thermal resistance value was calculated using total electrical input power; optical power was not subtracted from input power.

Absolute Maximum Ratings

Table 5: Maximum Ratings

Parameter	Maximum Rating
LED Junction Temperature (T_j)	135°C
Storage Temperature	-40°C to +125°C
Operating Solder Point Temperature (T_{sp})	-40°C to +105°C
Soldering Temperature	260°C or lower for a maximum of 10 seconds
Maximum Drive Current ¹	1400mA
Maximum Peak Pulsed Forward Current ²	2000mA
Maximum Reverse Voltage ³	-5V
Moisture Sensitivity Rating	MSL 3
Electrostatic Discharge	2kV HBM. JEDEC-JS-001-HBM and JEDEC-JS-001-2012

Notes for Table 5:

1. The maximum drive current is limited depending on the solder point temperature. Refer to Figure 7.
2. Bridgelux recommends a maximum duty cycle of 10% and pulse width of 10 ms when operating CSP LED at maximum peak pulsed current specified. Maximum peak pulsed currents indicate values where CSP LED can be driven without catastrophic failures.
3. Light emitting diodes are not designed to be driven in reverse voltage and will not produce light under this condition. Maximum rating provided for reference only.

Product Bin Definitions

Table 6 lists the standard photometric luminous flux bins for Bridgelux CSP 2424 LEDs. Although several bins are outlined, product availability in a particular bin varies by production run and by product performance. Not all bins are available in all CCTs.

Table 6: Luminous Flux Bin Definitions at 700mA, $T_{sp} = 85^{\circ}\text{C}$

Bin Code	Minimum	Maximum	Unit	Condition
C8	130	150	lm	$I_F = 700\text{mA}$
C9	150	170		
D2	170	190		
D3	190	210		
D4	210	230		
D5	230	250		
D6	250	270		
D7	270	290		
D8	290	310		
D9	310	330		
E6	330	350		
E7	350	370		
E8	370	390		

Note for Table 6:

1. Bridgelux maintains a tolerance of $\pm 7.5\%$ on luminous flux measurements.

Table 7: Forward Voltage Bin Definition at 700mA, $T_{sp} = 85^{\circ}\text{C}$

Bin Code	Minimum	Maximum	Unit	Condition
C	2.6	2.8	V	$I_F = 700\text{mA}$
D	2.8	3.0		
E	3.0	3.2		

Note for Table 7:

1. Bridgelux maintains a tolerance of $\pm 0.1\text{V}$ on forward voltage measurements.

Product Bin Definitions

Table 8: 3- and 5-step MacAdam Ellipse Color Bin Definitions ($T_{sp}=85^{\circ}\text{C}$)

Table 8: 3- and 5-step MacAdam Ellipse Color Bin Definitions ($T_{sp}=85^{\circ}\text{C}$)							
CCT	Color Space	Center Point		Major Axis	Minor Axis	θ (Angle)	Color Bin
		x	y				
1800K	3	0.5496	0.4082	0.00698	0.00393	40.000	3
	5			0.01164	0.00655		5(E/F/G/H)
2000K	3	0.5251	0.4120	0.00723	0.00399	51.000	3
	5			0.01205	0.00665		5(E/F/G/H)
2200K	3	0.5056	0.4152	0.00723	0.00399	51.918	3
	5			0.01205	0.00665		5(E/F/G/H)
2700K	3	0.4578	0.4101	0.00810	0.00420	53.700	3
	5			0.01350	0.00700		5(E/F/G/H)
3000K	3	0.4338	0.4030	0.00834	0.00408	53.220	3
	5			0.01390	0.00680		5(E/F/G/H)
3500K	3	0.4073	0.3917	0.00927	0.00414	54.000	3
	5			0.01545	0.00690		5(E/F/G/H)
4000K	3	0.3818	0.3797	0.00939	0.00402	53.720	3
	5			0.01565	0.00670		5(E/F/G/H)
5000K	3	0.3447	0.3553	0.00822	0.00354	59.620	3
	5			0.01370	0.00590		5(E/F/G/H)
5700K	3	0.3287	0.3417	0.00746	0.00320	59.090	3
	5			0.01243	0.00533		5(E/F/G/H)
6500K	3	0.3123	0.3282	0.00669	0.00285	58.570	3
	5			0.01115	0.00475		5(E/F/G/H)

Note for Table 8:

1. Bridgelux maintains a tolerance of ± 0.007 on x and y color coordinates in the CIE 1931 color space.
2. MacAdam Ellipse Color bin code for $\text{CRI} \geq 90$: 3(3 SDCM)/ EFGH(5 SDCM).
3. MacAdam Ellipse Color bin code for $\text{CRI} < 90$: 3(3 SDCM)/ 5(5 SDCM).

Product Bin Definitions

Figure 1: C.I.E. 1931 Chromaticity Diagram (Color Bin Structure, $T_{sp} = 85^{\circ}\text{C}$)

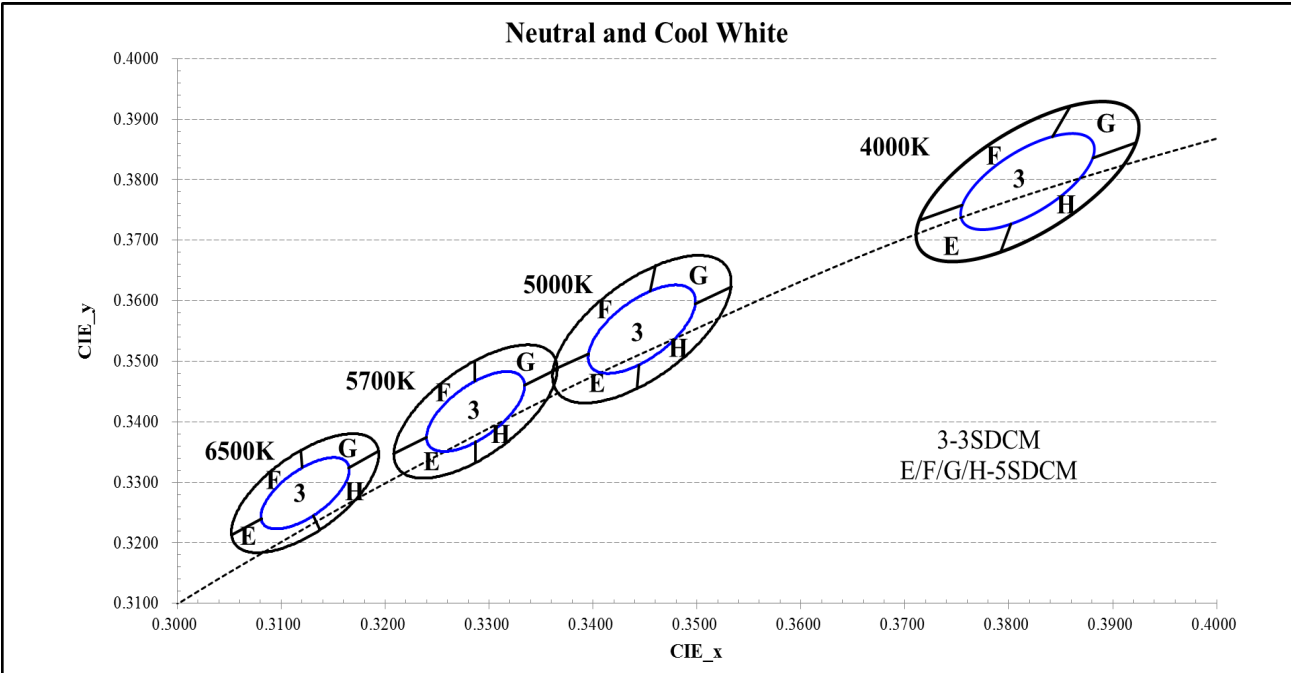
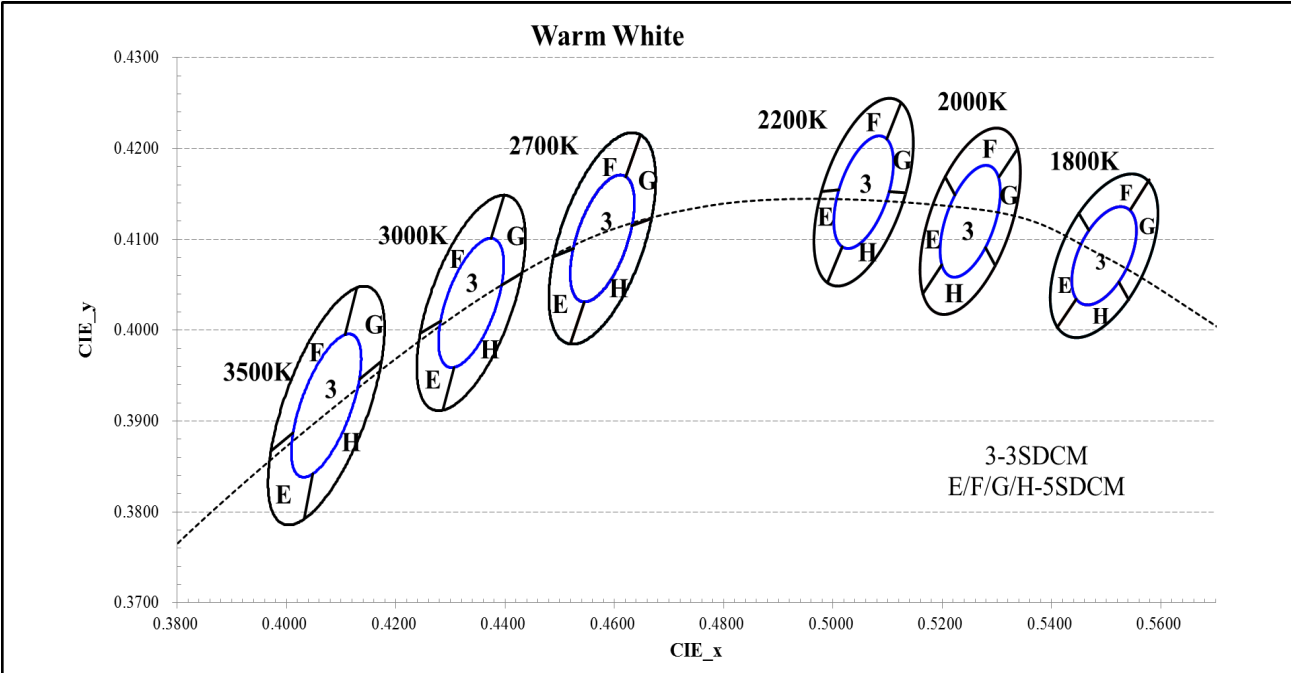

Performance Curves

Figure 2: Drive Current vs. Voltage ($T_{sp}=85^{\circ}\text{C}$)

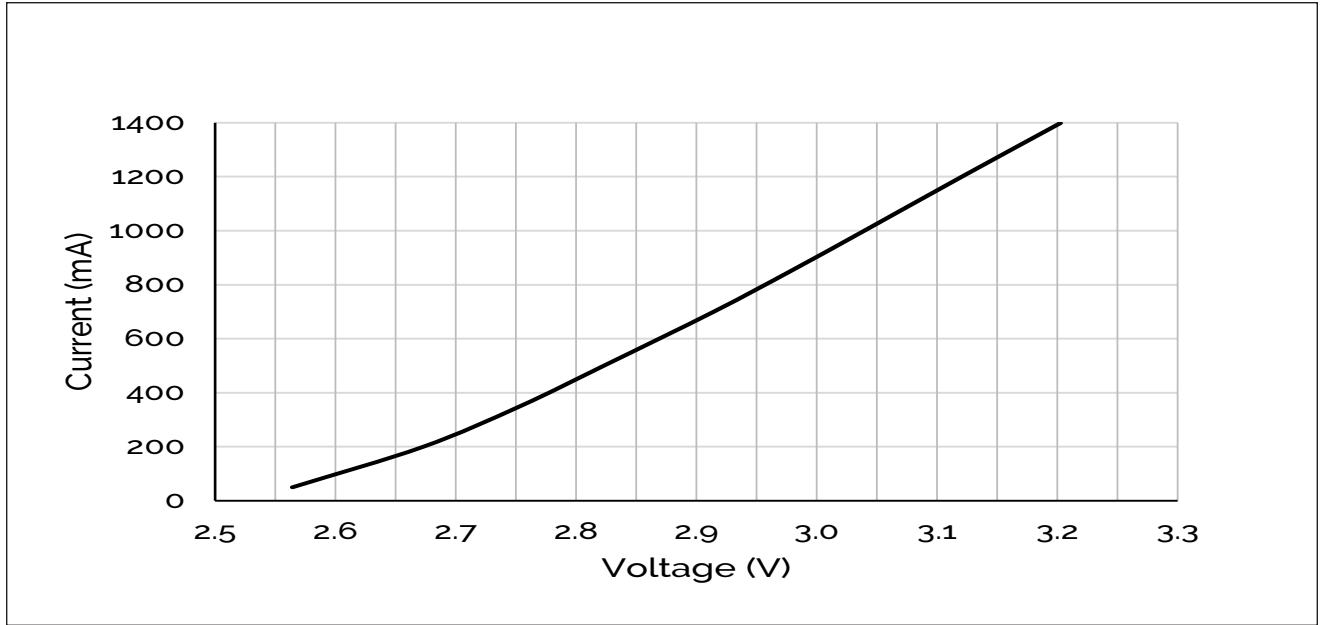
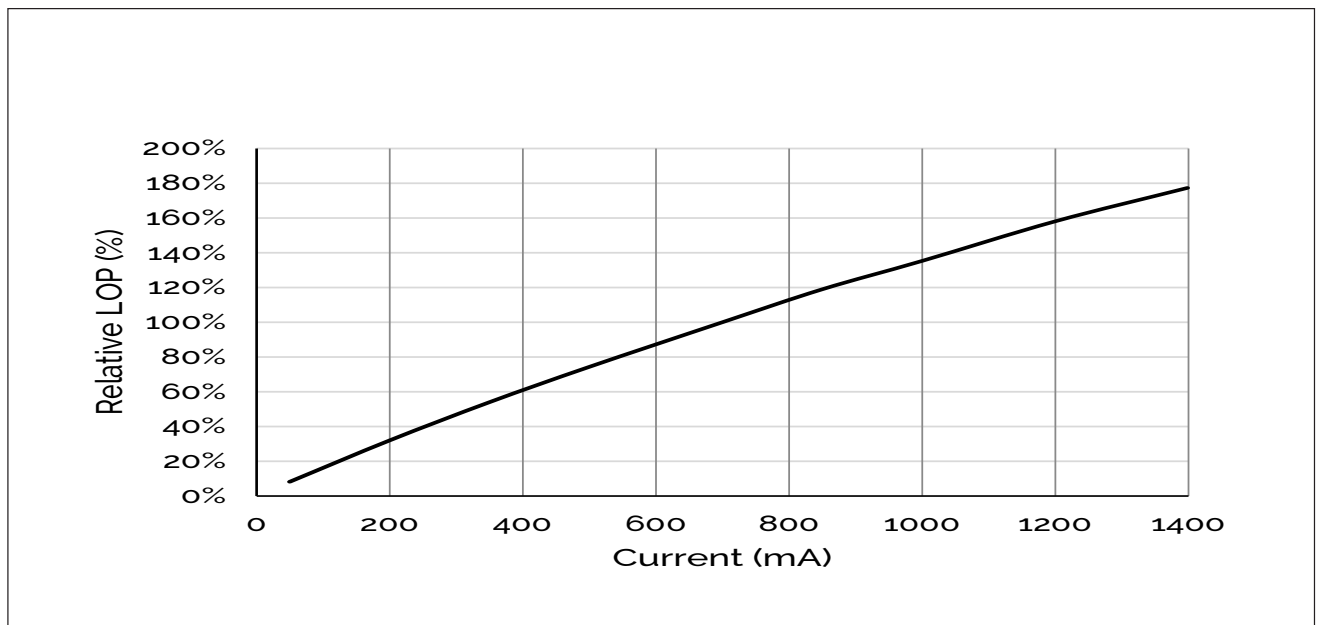

Figure 3: Typical Relative Luminous Flux vs. Drive Current ($T_{sp}=85^{\circ}\text{C}$)



Note for Figure 3:

1. Bridgelux does not recommend driving this CSP LED at low current ($< 10\text{mA}$). Doing so may produce unpredictable results. Pulse width modulation (PWM) is recommended for dimming effects.

Performance Curves

Figure 4: Typical Relative Flux vs. Solder Point Temperature_700mA

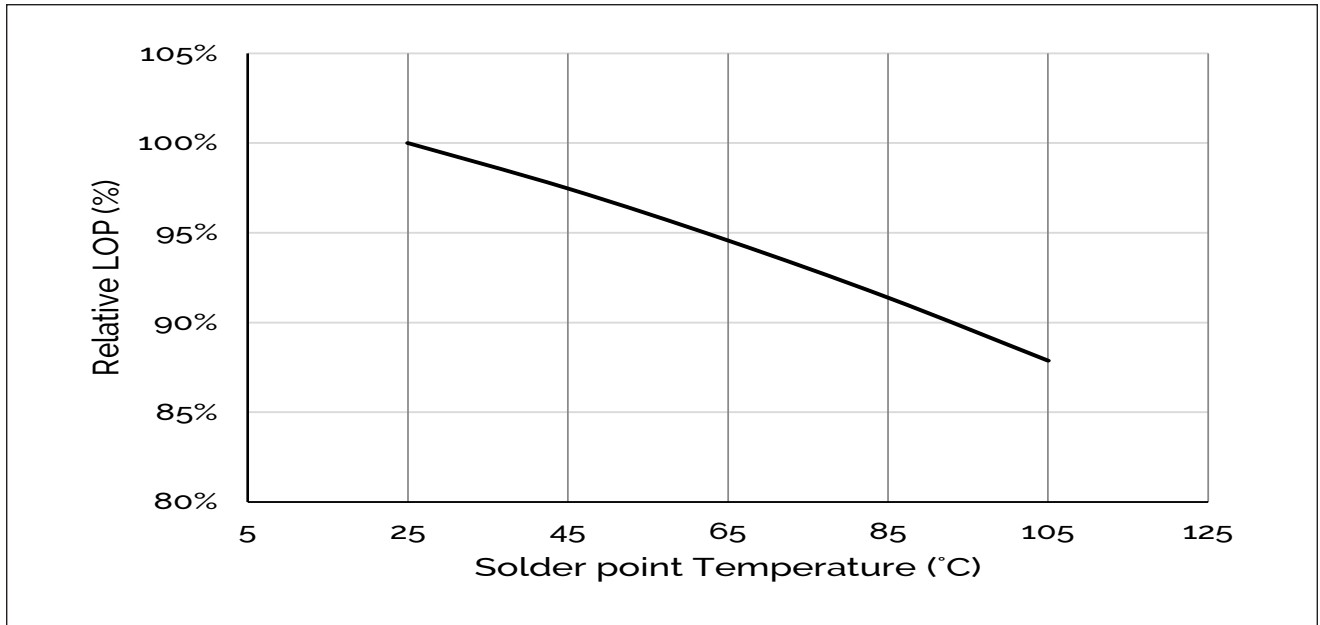
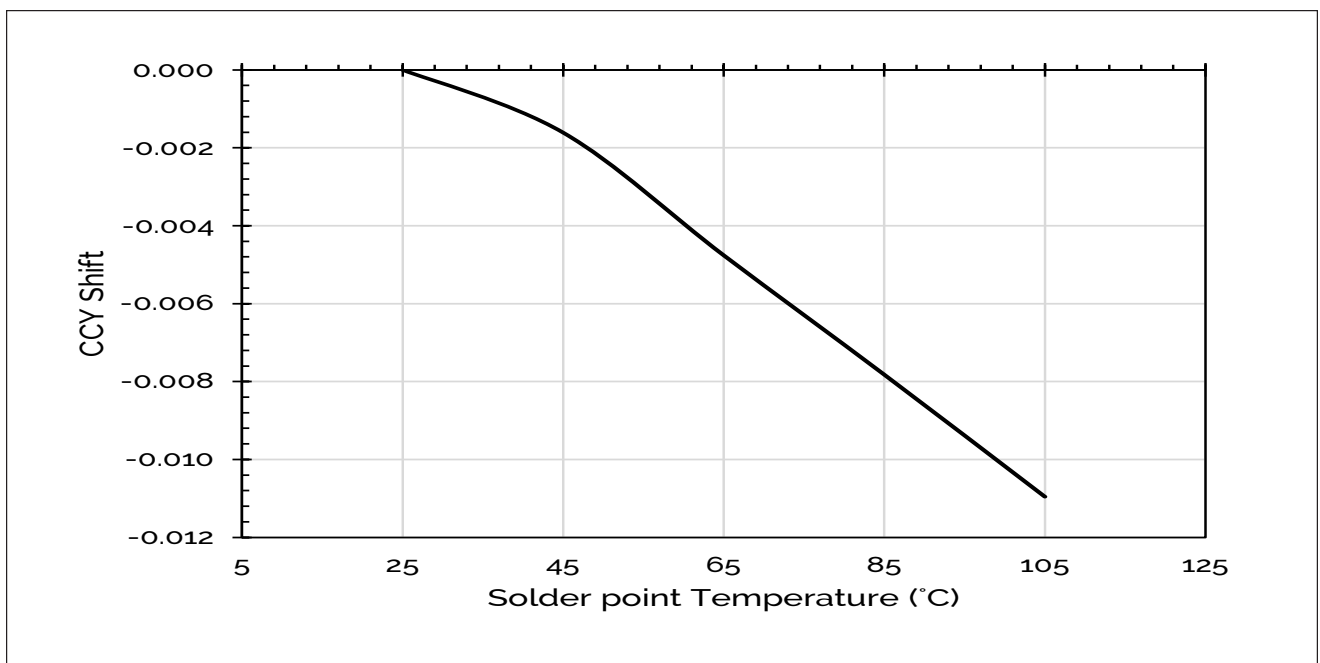

Figure 5: Typical ccY Shift vs. Solder Point Temperature_700mA



Notes for Figures 4 & 5:

1. Characteristics shown for neutral white based on 4000K and 70 CRI.
2. For other color SKUs, the shift in color will vary. Please contact your Bridgelux Sales Representative for more information.

Performance Curves

Figure 6: Typical ccx Shift vs. Solder Point Temperature_700mA

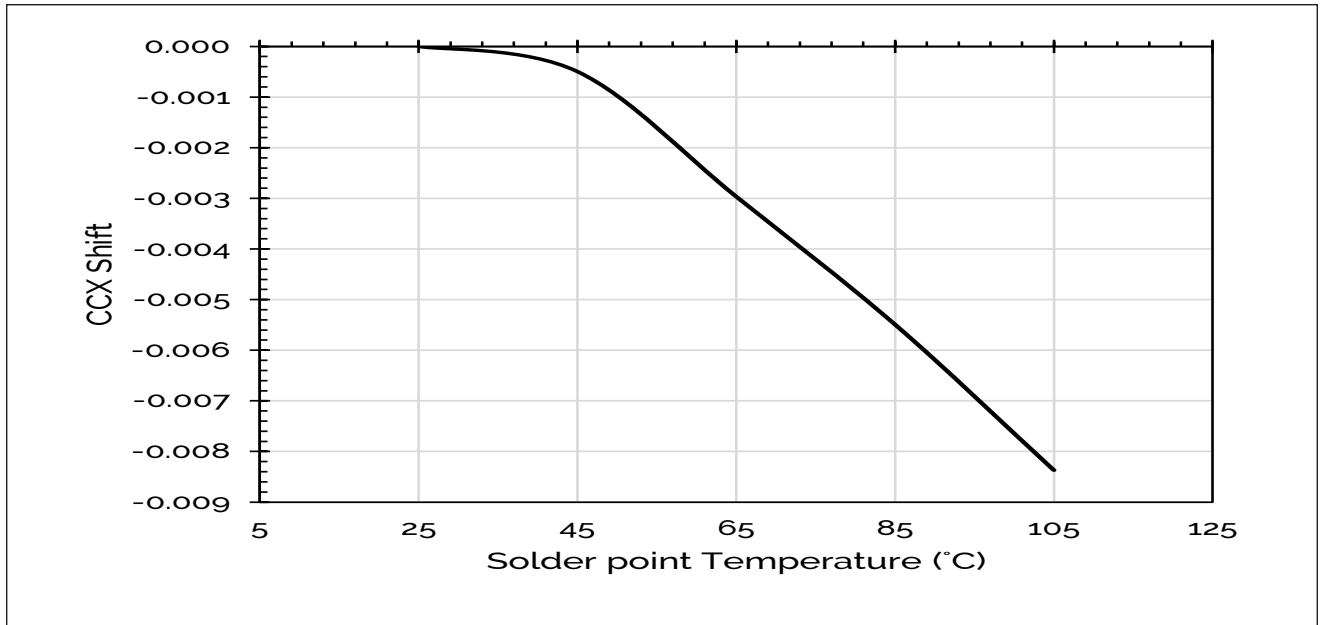

Notes for Figure 6:

1. Characteristics shown for warm white based on 4000K and 70 CRI.
2. For other color SKUs, the shift in color will vary. Please contact your Bridgelux Sales Representative for more information.

Figure 7: Drive Current vs Solder Point Temperature

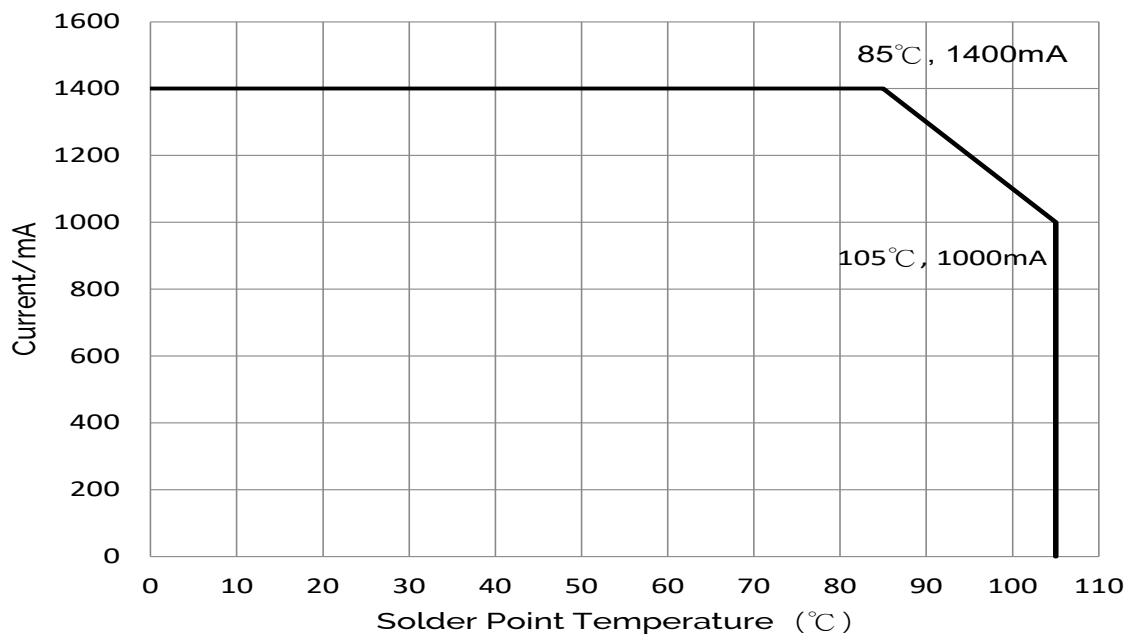

Typical Radiation Pattern

Figure 8: Typical Spatial Radiation Pattern at 700mA, $T_{sp} = 25^{\circ}\text{C}$

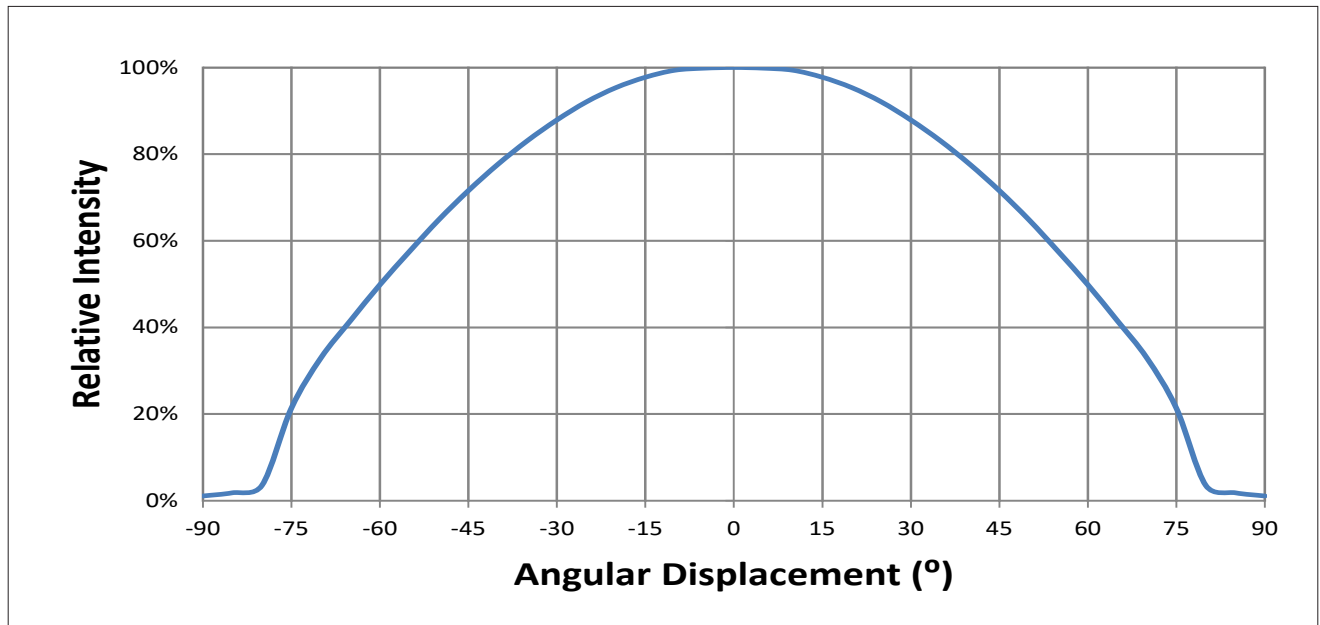

Notes for Figure 8:

1. Typical viewing angle is 120° .
2. The viewing angle is defined as the off axis angle from the centerline where I_v is $\frac{1}{2}$ of the peak value.

Figure 9: Typical Polar Radiation Pattern at 700mA, $T_{sp} = 25^{\circ}\text{C}$

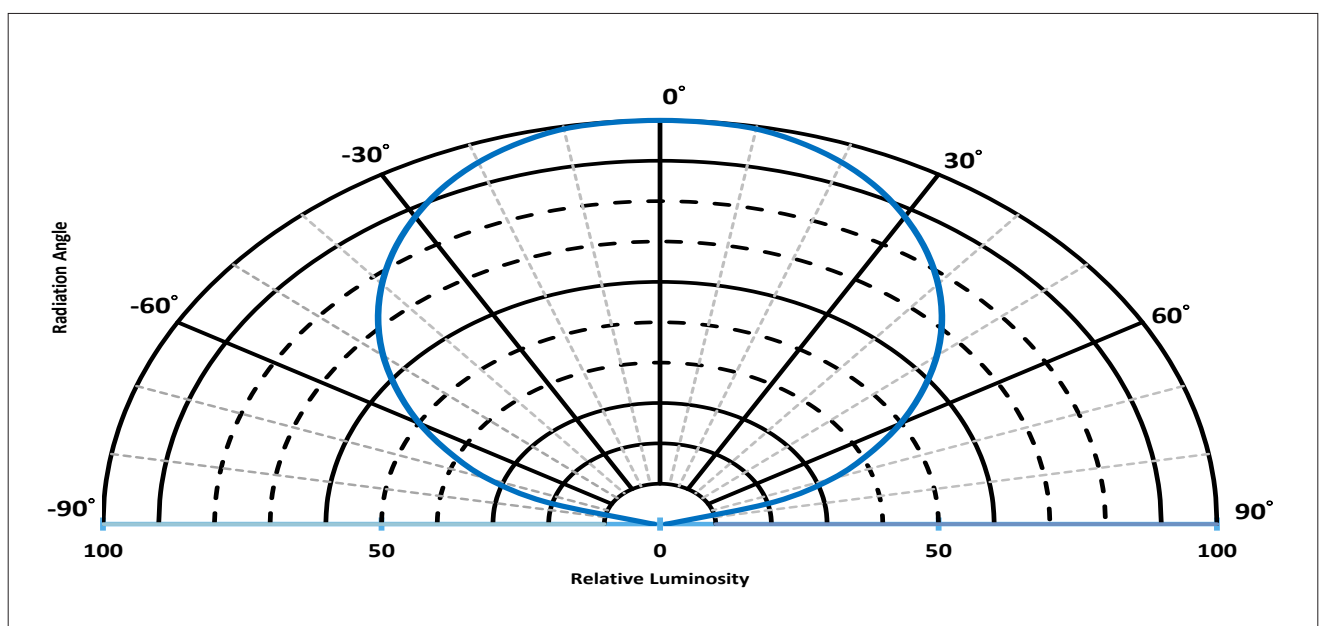

Typical Color Spectrum

Figure 10: Typical Color Spectrum at 700mA, Tsp=85°C

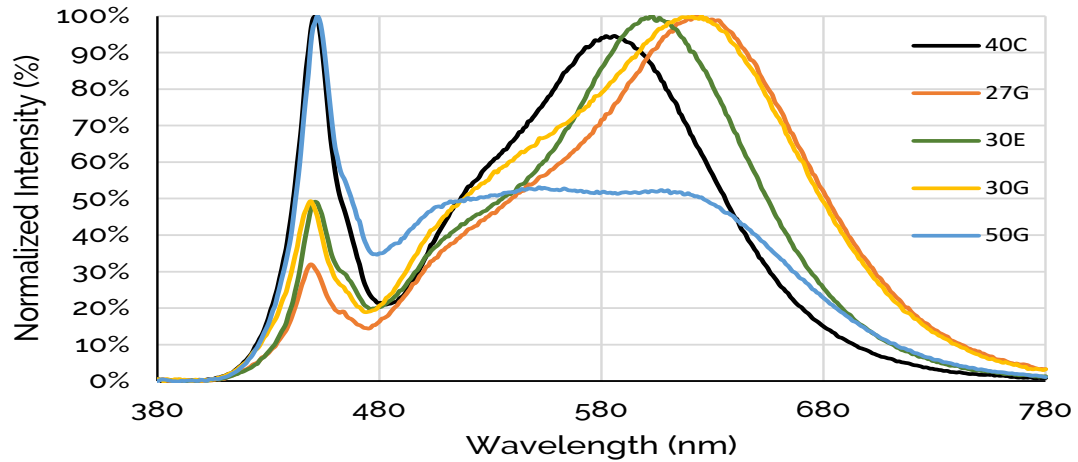

Notes for Figure 10:

1. Color spectra shown for neutral white is 4000K and 70 CRI.
2. Color spectra shown for warm white is 2700K and 90 CRI.
3. Color spectra shown for warm white is 3000K and 80 CRI.
4. Color spectra shown for warm white is 3000K and 90 CRI.
5. Color spectra shown for cool white is 5000K and 90 CRI.

Mechanical Dimensions

Figure 11: Drawing for CSP 2424

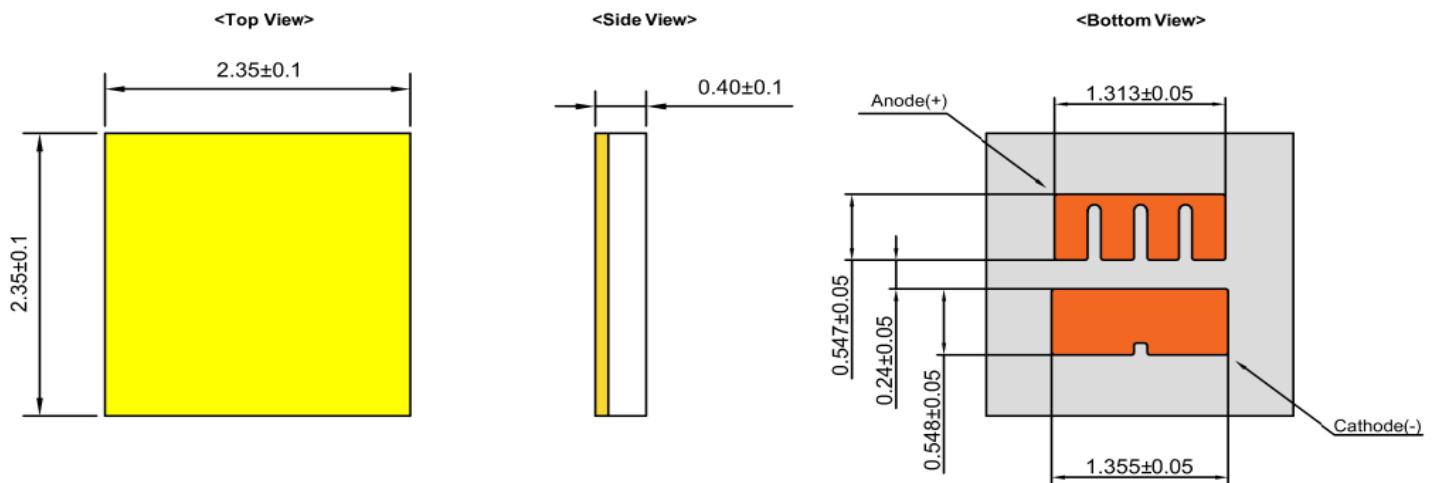

Notes for Figure 11:

1. Drawings are not to scale.
2. Drawing dimensions are in millimeters.
3. Unless otherwise specified, tolerances are ± 0.10 mm.
4. The optical center of the LED emitter is nominally defined by the mechanical center of the emitter. The light emitting surface (LES) is centered on the mechanical center of the LED emitter to a tolerance of ± 0.2 mm

Recommended PCB Soldering Pad Pattern

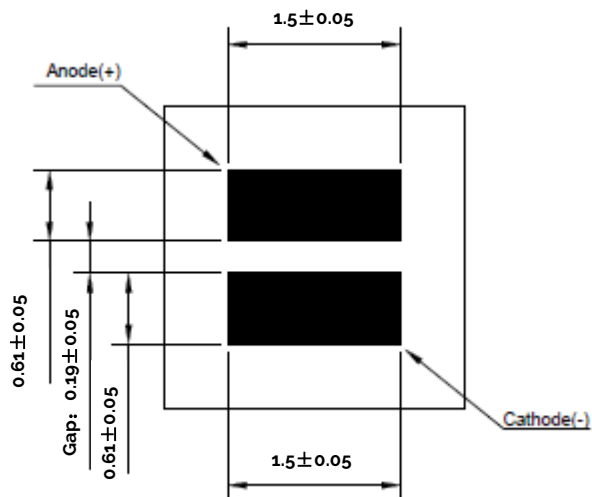

Reliability

Table 9: Reliability Test Items and Conditions

No .	Items	Reference Standard	Test Conditions	Drive Current	Test Duration	Units Failed/Tested
1	Moisture Sensitivity Level	J-STD-020E	$T_{\text{slid}} = 260^{\circ}\text{C}$, 10sec, Precondition: 85°C , 60%RH, 168hr		3 reflows	0/22
2	Low Temperature Storage	JESD22-A119	$T_{\text{a}} = -40^{\circ}\text{C}$		1000 hours	0/22
3	High Temperature Storage	JESD22-A103D	$T_{\text{a}} = 125^{\circ}\text{C}$		1000 hours	0/22
4	Low Temperature Operating Life	JESD22-A108D	$T_{\text{a}} = -40^{\circ}\text{C}$	1400mA	1000 hours	0/22
5	Temperature Humidity Operating Life	JESD22-A101C	$T_{\text{sp}} = 85^{\circ}\text{C}$, RH=85%	1400mA	1000 hours	0/22
6	High Temperature Operating Life	JESD22-A108D	$T_{\text{sp}} = 85^{\circ}\text{C}$	1400mA	1000 hours	0/22
7	Power Switching	IEC62717	$T_{\text{sp}} = 85^{\circ}\text{C}$, ON 30s OFF 30s	1400mA	30000 Cycle	0/22
8	Thermal Shock	JESD22-A106B	$T_{\text{a}} = -40^{\circ}\text{C} \sim 125^{\circ}\text{C}$; Dwell : 15min; Transfer: 10sec		200 Cycle	0/22
9	Electrostatic Discharge	JS-001-2012	HBM, 2KV, 15k Ω , 100pF, Alternately positive or negative			0/22
10	Vibration Test	JESD22-B103	10m/s ² , 100-20000-100Hz 4 cycles,4min,eachX,Y,Z		4 Cycles	0/22

Passing Criteria

Item	Symbol	Test Condition	Passing Criteria
Forward Voltage	Vf	1400mA	$\Delta V_f < 10\%$
Luminous Flux	Iv	1400mA	$\Delta I_v < 30\%$
Chromaticity Coordinates	(x, y)	1400mA	$\Delta u'v' < 0.007$

Notes for Table 9:

1. Test board: Aluminum board thickness -1.0mm, Copper layer thickness-70um.
2. Measurements are performed after allowing the LEDs to return to room temperature
3. T_{slid} : reflow soldering temperature; T_{a} : ambient temperature

Reflowing Characteristics

Figure 12 : Reflow Profile

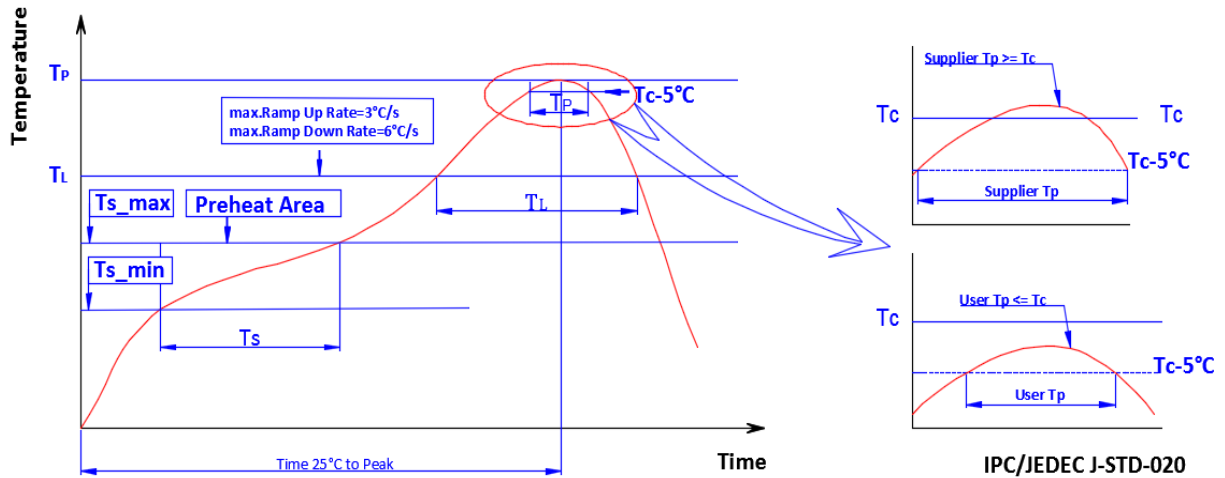

Profile Parameters	Lead-Free Solder SAC305
Average Ramp-Up Rate (T_s_{max} to T_p)	3°C/second max.
Preheat: Temperature Min (T_s_{min})	150°C
Preheat: Temperature Max (T_s_{max})	190°C
Preheat: Time ($t_{s_{min}}$ to $t_{s_{max}}$)	90-120 seconds
Liquidous Temperature (T_l)	217°C
Time Maintained Above Liquidous Temperature (T_l): Time (t_l)	60-90 seconds
Peak/Classification Temperature (T_p)	250-255°C
Time Within 10°C of Actual Peak Temperature (T_p)	20-40 seconds
Ramp-Down Rate	6°C/second max
Time 25°C to Peak Temperature	8 minutes max.

Packaging

Figure 13: Reel Drawings

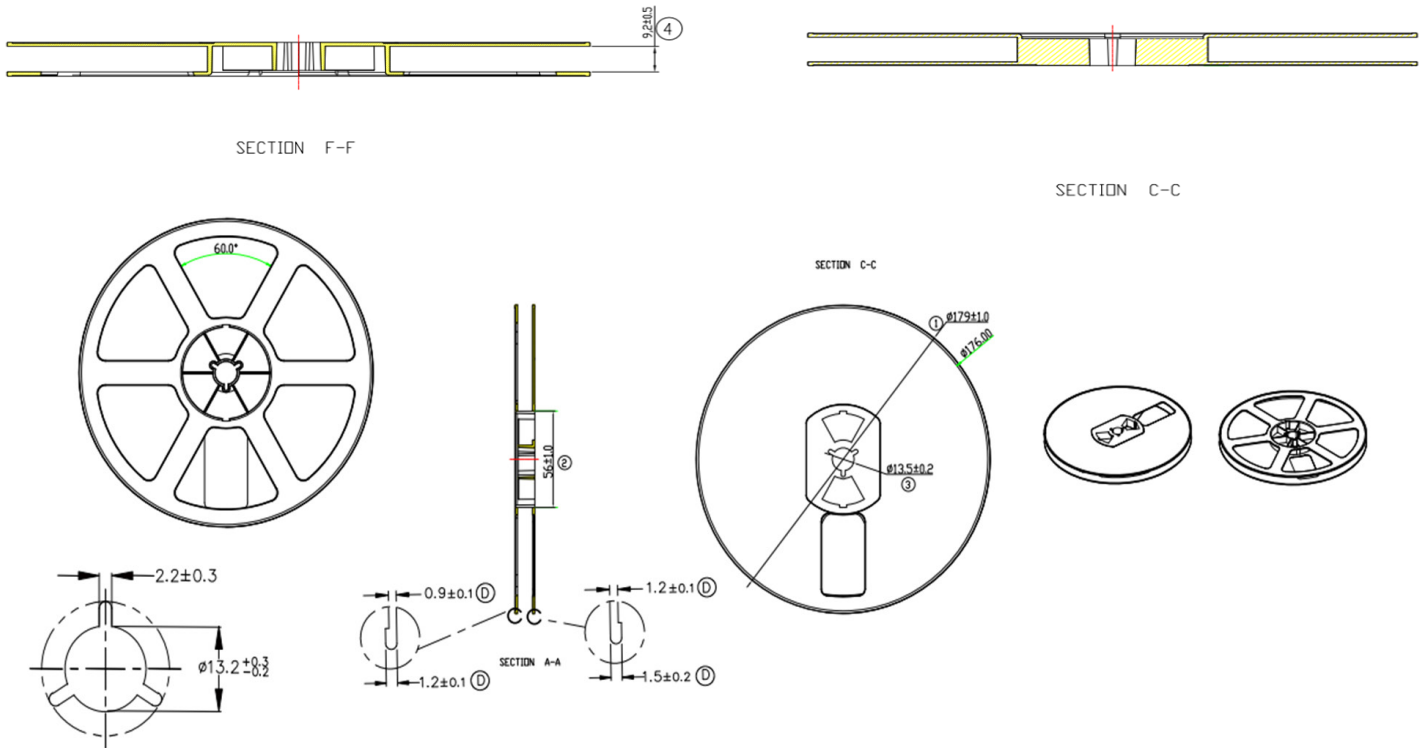

Note for Figure 13:

1. Drawings are not to scale. Drawing dimensions are in millimeters.

Figure 14: Tape Drawings

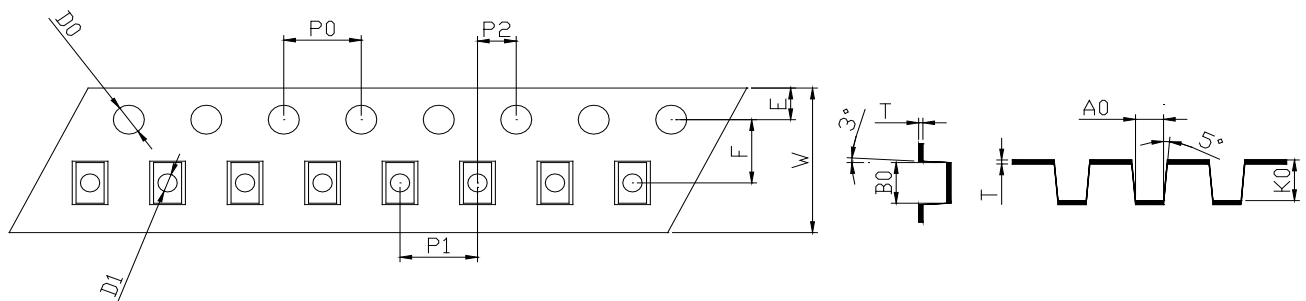

W	T	A0	B0	K0	D0	D1	E	F	P0	P1	P2	10P0
8.00±0.05	0.20±0.02	2.50±0.05	2.50±0.05	0.55±0.05	1.60±0.10	1.10±0.10	1.75±0.10	3.50±0.10	4.00±0.10	4.00±0.10	2.00±0.10	40.00±0.20

Note for Figure 14:

1. Drawings are not to scale. Drawing dimensions are in millimeters.

Packaging

Figure 15: Reel Packaging Drawings

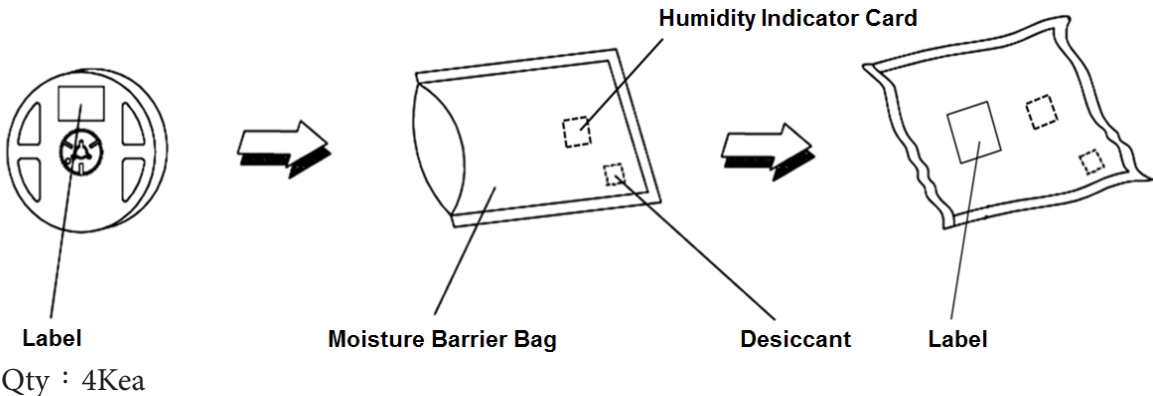

Note for Figure 15:
1. Drawings are not to scale.

Design Resources

Optical Source Models

Please contact your Bridgelux sales representative for assistance.

Precautions

CAUTION: CHEMICAL EXPOSURE HAZARD

Exposure to some chemicals commonly used in luminaire manufacturing and assembly can cause damage to the CSP.

CAUTION: EYE SAFETY

Eye safety classification for the use of Bridgelux CSP is in accordance with IEC specification 62471: Photobiological Safety of Lamps and Lamp Systems. Most Bridgelux CSPs are classified as Risk Group Exempt or Risk Group 1 in accordance with IEC specification 62471. However, the CSP LEDs will be classified as Risk Group 2 when operated at high power conditions with high ratio blue wavelength in the emission spectrum depending on characteristics. Please use appropriate precautions. It is important that employees working with LEDs are trained to use them safely.

CAUTION: RISK OF BURN

Do not touch the CSP LES during operation. Allow the CSP to cool for a sufficient period of time before handling. The CSP may reach elevated temperatures such that could burn skin when touched.

CAUTION: PICK AND PLACE

Recommend using Teflon material for nozzle. Sharp steel material must not be used as pick up tools.

CAUTION

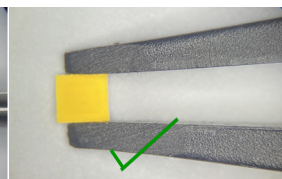
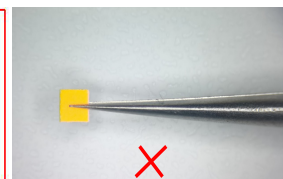
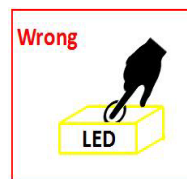

Disclaimers

MINOR PRODUCT CHANGE POLICY

The rigorous qualification testing on products offered by Bridgelux provides performance assurance. Slight cosmetic changes that do not affect form, fit, or function may occur as Bridgelux continues product optimization.

STANDARD TEST CONDITIONS

Unless otherwise stated, LED emitter testing is performed at the nominal drive current.

About Bridgelux: Bridging Light and Life™

At Bridgelux, we help companies, industries and people experience the power and possibility of light. Since 2002, we've designed LED solutions that are high performing, energy efficient, cost effective and easy to integrate. Our focus is on light's impact on human behavior, delivering products that create better environments, experiences and returns—both experiential and financial. And our patented technology drives new platforms for commercial and industrial luminaires.

For more information about the company, please visit
bridgelux.com
twitter.com/Bridgelux
facebook.com/Bridgelux
WeChat ID: BridgeluxInChina



46410 Fremont Boulevard
Fremont, CA 94538 U.S.A.
Tel (925) 583-8400
www.bridgelux.com

© 2022 Bridgelux, Inc. All rights reserved. Product specifications are subject to change without notice. Bridgelux and the Bridgelux stylized logo design are registered trademarks of Bridgelux, Inc. All other trademarks are the property of their respective owners.

Bridgelux CSP 2424 Product Data Sheet DS962 Rev. C (03/2025)