

Bridgelux® Vesta® Series Tunable White Gen 2 9mm Array, 90 CRI and Thrive™

Product Data Sheet DS350



Introduction

Vesta® Series

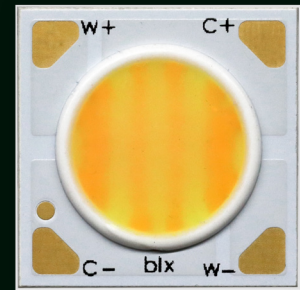

Vesta® Series Tunable White Array products deliver adaptable light in a solid-state lighting package, tapping into the powerful emotional elements of light and color to influence experience, well-being, and human emotion. They allow designers to mimic daylight to increase productivity and well-being, retailers to influence shopper behavior, and fixture manufacturers to simulate the familiar glow and dimming of incandescent lamps. These high flux density light sources are designed to support a wide range of high-quality directional luminaires and replacement lamps for commercial and residential applications.

Lighting systems incorporating these LED arrays deliver comparable performance to 150-Watt incandescent based luminaires, while increasing system level efficacy and prolonging service life. Typical luminaire and lamp types appropriate for this family include replacement lamps, down lights, wall packs, accent, spot, and track lights.

Vesta Series Tunable White Array products are also now available with Bridgelux Thrive™ white points, which combine unique chip, phosphor, and packaging technology to closely match the spectra of natural light. Thrive can be used in constant color point luminaires to bring full spectrum natural light indoors or in tunable white luminaires to incorporate circadian elements that may impact human well-being. The high-fidelity spectral output of Thrive creates stunning environments with excellent color rendering and outstanding TM30 metrics. Thrive is available in SMD components, LED arrays, and linear modules to enable a broad range of lighting applications including retail, hospitality, office, education, architectural, museums, healthcare and residential lighting.

Features

- Tuning range options of 2700K-5000K, 2700K-6500K, 1800K-3000K, and 1800K-4000K
- CRI >90 and Thrive with typical 98 CRI, R1-R15 >90, and TM-30 Rf 96 and Rg 99
- Typical ASD values for Thrive of 11% for 2700K, 9% for 5000K and 8% for 6500K
- Proprietary packaging technology to improve near field color uniformity
- Flux packages of up to 1190 lumens
- High efficiencies of up to 137 lm/W
- 3 SDCM binning for 2700K, 3000K, 4000K, 5000K and 6500K color points

Benefits

- Maximum design flexibility, the industry's largest selection of tuning ranges
- Natural and vivid color rendering
- Closest match to natural light available over 425nm to 690nm wavelength range
- Suitable for most narrow beam optics of ≥ 15 degrees FWHM
- Delivers the required lumens for a wide variety of lighting applications
- Greater energy savings, lower utility costs
- Precise color mixing and consistency



Contents

Product Feature Map	2
Product Nomenclature	2
Product Selection Guide	3
CRI and TM30 Characteristics for Vesta Arrays with Thrive	4
Average Spectral Difference	5
Electrical Characteristics	6
Absolute Maximum Ratings	7
Performance Curves	8 - 12
Typical Radiation Pattern	13
Typical Color Spectrum	14
Mechanical Dimensions	15
Color Binning Information	16
Packaging and Labeling	17
Design Resources	18
Precautions	18
Disclaimers	18
About Bridgelux	19

Product Feature Map

Bridgelux arrays are fully engineered devices that provide consistent thermal and optical performance on an engineered mechanical platform. The arrays incorporate several features to simplify design integration and assembly. Please visit www.bridgelux.com for more information on the Vesta Series family of products.

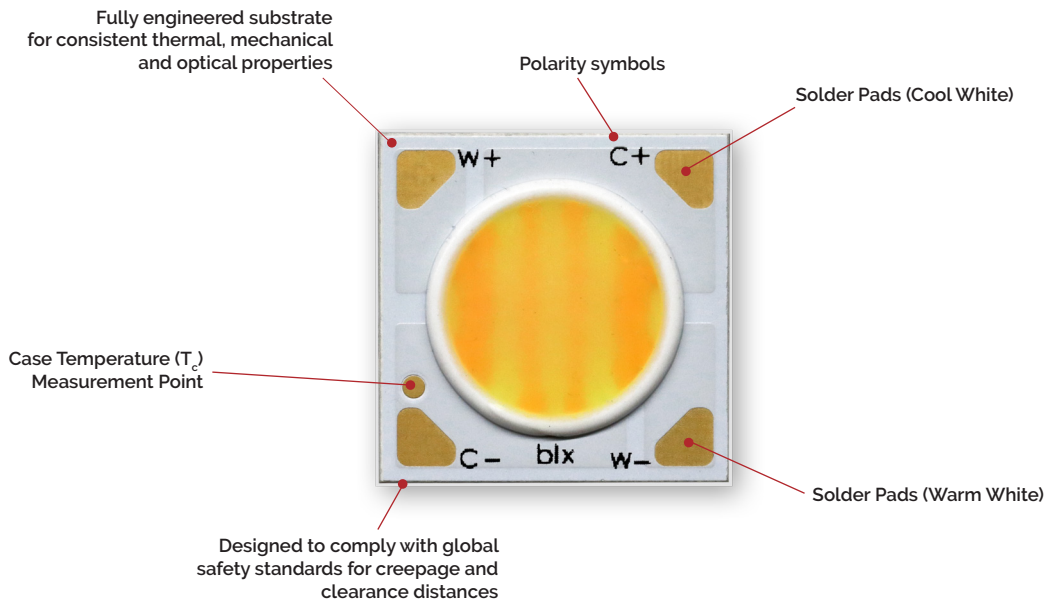

Product Nomenclature

The part number designation for Bridgelux Vesta Series arrays is explained as follows:

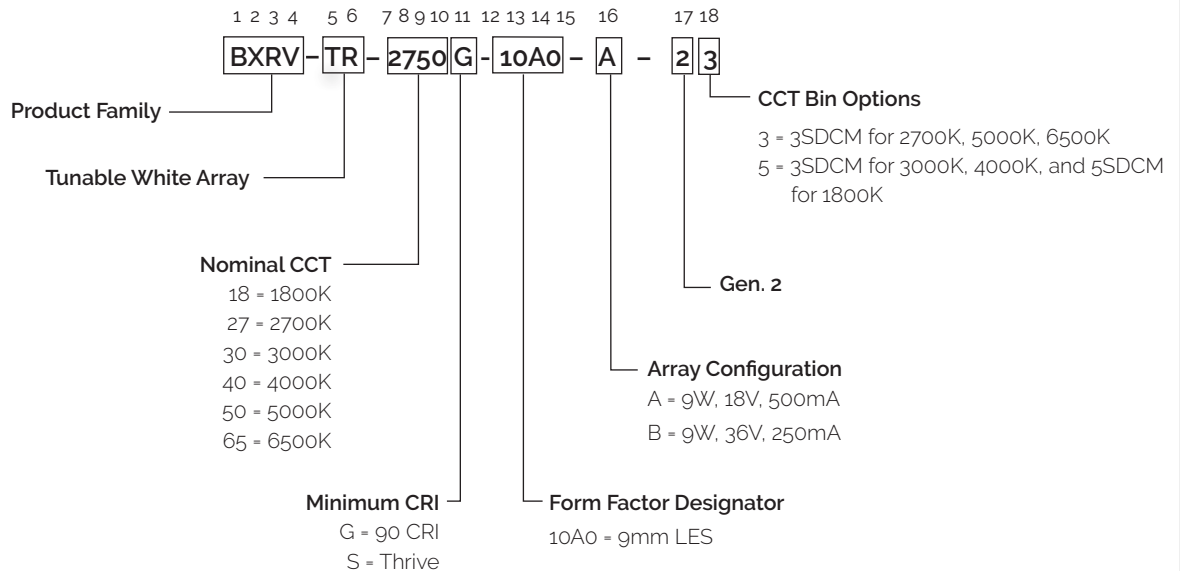

Product Selection Guide

The following product configurations are available:

Table 1: Selection Guide, Measurement Data

Part Number	Nominal CCT ¹ T _c =85°C (K)	Typical CRI ² T _c =85°C	Nominal Drive Current per channel (mA)	Typical V _f ³ T _c =25°C (V)	Typical Power T _c =25°C (W)	Typical Pulsed Flux ^{3,4,5} T _c =25°C (lm)	Typical Efficacy T _c =25°C ⁵ (lm/W)	Minimum Pulsed Flux T _c =25°C ⁸ (lm)	Typical DC Flux T _c =85°C ^{6,7} (lm)
BXRV-TR-2750G-10A0-A-23	2700	93	500	17.6	8.8	990	111	891	881
	5000	92	500	18.0	9.0	1153	126	1038	1015
BXRV-TR-2765G-10A0-A-23	2700	93	500	17.6	8.8	990	111	891	881
	6500	92	500	18.0	9.0	1177	128	1059	1036
BXRV-TR-2750G-10A0-B-23	2700	93	250	34.8	8.7	990	112	891	866
	5000	92	250	34.8	8.7	1180	136	1062	1038
BXRV-TR-2765G-10A0-B-23	2700	93	250	34.8	8.7	990	112	891	866
	6500	92	250	34.8	8.7	1190	137	1071	1047
BXRV-TR-2750S-10A0-B-23	2700	98, Thrive	250	34.8	8.7	842	97	757	749
	5000	98, Thrive	250	34.8	8.7	1003	115	903	903
BXRV-TR-2765S-10A0-B-23	2700	98, Thrive	250	34.8	8.7	842	97	757	749
	6500	98, Thrive	250	34.8	8.7	1012	116	910	910
BXRV-TR-1830G-10A0-B-25	1800	93	250	34.8	8.7	625	72	588	555
	3000	92	250	34.8	8.7	980	113	921	860
BXRV-TR-1840G-10A0-A-25	1800	93	500	17.6	8.8	610	69	573	543
	4000	92	500	18.0	9.0	1060	118	996	933

Notes for Table 1:

- Nominal CCT as defined by ANSI C78.377-2011.
- For CRI 92-93 products, the minimum CRI value is 90 and the minimum R_g value is 50. For CRI 98 Thrive products, the minimum CRI value is 95. Bridgelux maintains a ±3 tolerance on all R_g values.
- Products tested under pulsed condition (10ms pulse width) at nominal test current where T_j (junction temperature) - T_c (case temperature) = 25°C.
- Typical performance values are provided as a reference only and are not a guarantee of performance.
- Bridgelux maintains a ±7% tolerance on flux measurements.
- Typical stabilized DC performance values are provided as reference only and are not a guarantee of performance.
- Typical performance is estimated based on operation under DC (direct current) with LED array based on operation under DC (direct current) with LED array mounted onto a heat sink with thermal interface material and the case temperature maintained at 85°C. Based on Bridgelux test setup, values may vary depending on the thermal design of the luminaire and/or the exposed environment to which the product is subjected.
- Minimum flux values at pulsed nominal test current are guaranteed by 100% test.

CRI and TM30 Characteristics for Vesta Arrays with Thrive

Table 2: Typical Color Rendering Index and TM-30 Values at $T_c=85^\circ\text{C}$

Nominal CCT ¹	R _r	R _g	R _a	R ₁	R ₂	R ₃	R ₄	R ₅	R ₆	R ₇	R ₈	R ₉	R ₁₀	R ₁₁	R ₁₂	R ₁₃	R ₁₄	R ₁₅
2700K	96	99	98	96	98	97	94	96	95	98	98	97	95	91	92	96	97	97
5000K	96	99	98	98	98	98	95	98	96	97	97	95	96	97	91	97	98	96
6500K	96	99	98	98	98	99	97	98	98	99	98	95	96	98	93	98	99	96

Note for Table 2:

1. Applicable for part numbers BXRV-TR-27xxS-10A0-B-23 with the Thrive spectrum
2. Bridgelux maintains a tolerance of ± 3 on Color Rendering Index R1-R15 measurements and TM-30 measurements.

Figure 1: 2700K Thrive TM-30 Graphs

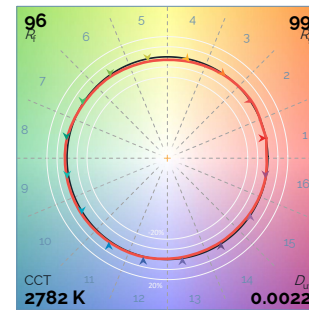
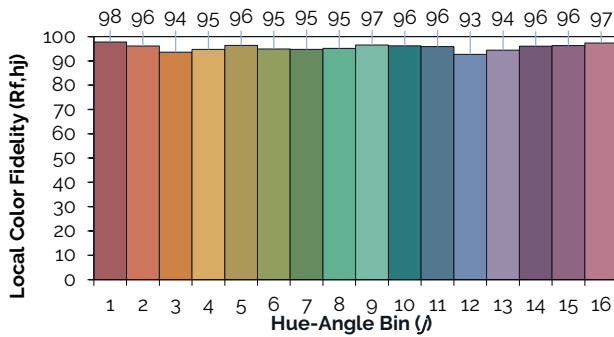

Figure 2: 5000K Thrive TM-30 Graphs

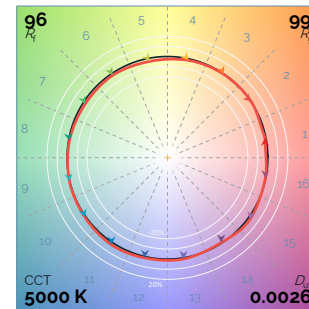
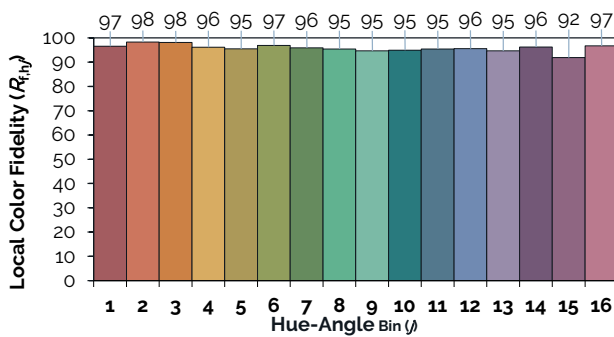
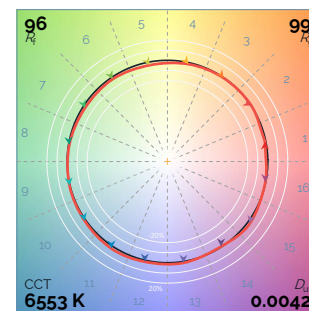
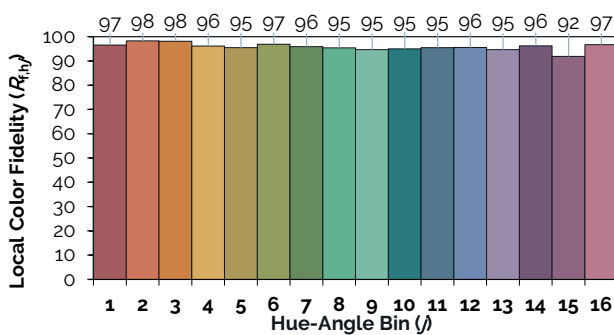

Figure 3: 6500K Thrive TM-30 Graphs



Average Spectral Difference

Spectral Matching to Natural Light

The lighting market is in the early stages of adoption of human-centric lighting (HCL). HCL encompasses the effects of lighting on the physical and emotional health and well-being of people. Throughout evolution, the human visual system has evolved under the natural light of sun and fire. These light sources have standardized industry spectral power definitions that describe the state of natural light. However, conventional metrics such as CCT, CRI, and TM-30 fail to adequately quantify the naturalness, or closeness of these light sources to the standardized natural spectra. Due to a lack of an industry standard metric to quantitatively measure the naturalness of a light source, Bridgelux has pioneered a new metric that takes the guesswork out of comparing LED light sources to natural light.

Average Spectral Difference, or ASD, is calculated by measuring the absolute difference between two spectra at discrete wavelengths. These values are averaged across a wavelength range derived from the photopic response curve, or $V(\lambda)$; a luminous efficiency function describing the average spectral sensitivity of human perception of brightness. The range of 425nm to 690nm was selected to remove the tails of the $V(\lambda)$ gaussian distribution below 1% of the peak value at 555nm, covering 99.9% of the area under the photopic response curve. Natural light is defined following the approach of IES TM-30; black body curves for light sources of $\leq 4000K$ and the CIE standard illuminant D for light sources of $\geq 5000K$.

Natural light has an ASD of 0%; lower ASD values indicate a closer match to natural light. Thrive is engineered to provide the closest match to natural light available using proprietary chip, phosphor and packaging technology, resulting in an ASD between 8% to 11% for all CCTs used in Vesta products. By comparison, standard 80, 90, and 98 CRI light sources have ASD values that are 100% to 300% larger than Thrive. To learn more about the ASD metric, please review the Bridgelux whitepaper: Average Spectral Difference, a new method to make objective comparisons of naturalness between light sources; or contact your Bridgelux sales representative.

Table 3: Typical ASD Values at $T_c=85^\circ C$

Nominal CCT	ASD
2700K	11%
5000K	9%
6500K	8%

Figure 4: SPD Comparison

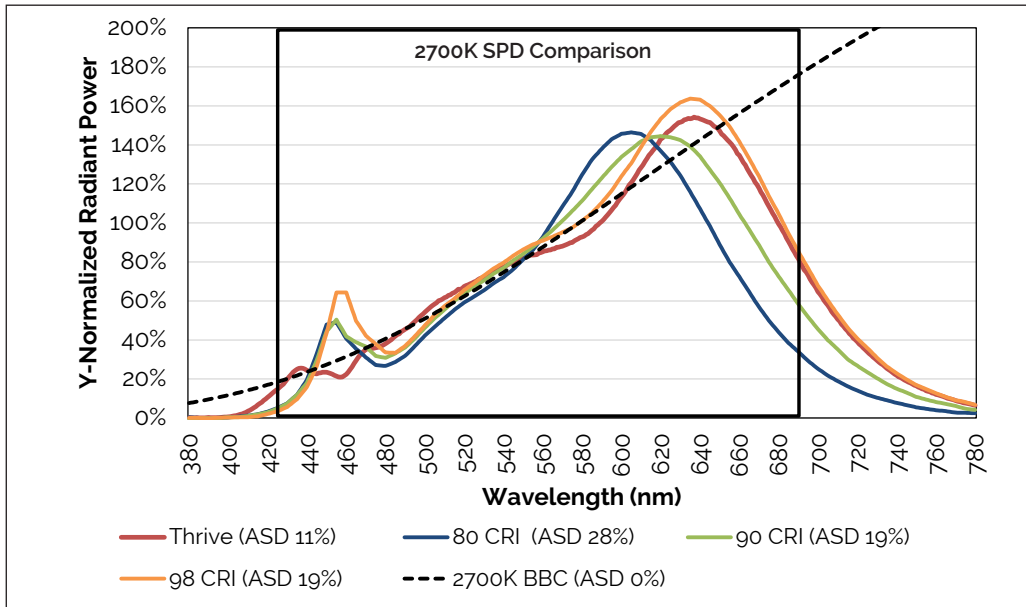

Electrical Characteristics

Table 4: Electrical Characteristics

Part Number	CCT $T_c = 85^\circ\text{C}$ (K)	Nominal Drive Current (mA)	Forward Voltage Pulsed, $T_c = 25^\circ\text{C}$ (V) ^{1, 2, 3, 7}			Typical Tem- perature Coefficient of Forward Voltage ⁴ $\Delta V_f / \Delta T_c$ (mV/ $^\circ\text{C}$)	Typical Thermal Resistance Junction to Case ⁵ R_{j-c} ($^\circ\text{C}/\text{W}$)	Driver Selection Voltages ⁶ (V)	
			Minimum	Typical	Maximum			V_f Min. Hot $T_c = 105^\circ\text{C}$ (V)	V_f Max. Cold $T_c = -40^\circ\text{C}$ (V)
BXRV-TR-27xxG-10A0-A-23	2700	500	16.3	17.6	18.4	-5.9	0.91	15.9	18.8
	5000/6500	500	16.8	18.0	18.9	-5.9		16.3	19.3
BXRV-TR-27xxX-10A0-B-23	2700	250	32.8	34.8	36.9	-12.8	0.86	31.8	37.8
	5000/6500	250	32.8	34.8	36.9	-12.8		31.8	37.8
BXRV-TR-1830G-10A0-B-25	1800	250	32.8	34.8	36.9	-12.8	0.86	31.8	37.8
	3000	250	32.8	34.8	36.9	-12.8		31.8	37.8
BXRV-TR-1840G-10A0-A-25	1800	500	16.3	17.6	18.4	-5.9	0.91	15.9	18.8
	4000	500	16.8	18.0	18.9	-5.9		16.3	19.3

Notes for Table 4:

- Parts are tested in pulsed conditions, $T_c = 25^\circ\text{C}$. Pulse width is 10ms.
- Voltage minimum and maximum are provided for reference only and are not a guarantee of performance.
- Bridgelux maintains a tester tolerance of $\pm 0.10\text{V}$ on forward voltage measurements.
- Typical temperature coefficient of forward voltage tolerance is $\pm 0.1\text{mV}$ for nominal current.
- Thermal resistance value was calculated using total electrical input power; optical power was not subtracted from input power. The thermal interface material used during testing is not included in the thermal resistance value.
- V_f min hot and max cold driver selection voltages are provided as reference only and are not guaranteed by test. These values are provided to aid in driver design and selection over the operating range of the product.
- This product has been designed and manufactured per IEC 62031:2014. This product has passed dielectric withstand voltage testing at 500 V. The working voltage designated for the insulation of the dielectric layer is 60V DC. The maximum allowable voltage across the array must be determined in the end product application.

Absolute Maximum Ratings

Table 5: Maximum Ratings

Parameter	Maximum Rating			
LED Junction Temperature (T_j)	125°C			
Storage Temperature	-40°C to +105°C			
Operating Case Temperature ¹ (T_c)	105°C			
Soldering Temperature ²	300°C or lower for a maximum of 6 seconds			
	BXRV-TR-xxxxG-10A0-A-23		BXRV-TR-xxxxX-10A0-B-2x	
	Channel 1	Channel 2	Channel 1	Channel 2
	2700K 1800K	5000K/6500K 4000K	2700K, 1800K	5000K/6500K 3000K
Maximum Combined Drive Current ⁴	700mA	700mA	480mA	480mA
Maximum Peak Pulsed Drive Current ⁵	960mA	720mA	500mA	500mA
Maximum Total Power	13.0W		18.0W	

Notes for Table 5:

- For IEC 62717 requirement, please contact Bridgelux Sales Support.
- See Bridgelux Application Note AN 92 for more information.
- Lumen maintenance and lifetime predictions are valid for drive current and case temperature conditions used for LM-80 testing as included in the applicable LM-80 test report. Contact your Bridgelux sales representatives for the LM-80 report.
- The Maximum Combined Drive Current is defined as the sum of the drive currents in both channels.
 Example for BXRV-TR-18xxG-10A0-B-23: If 480mA is applied to one channel, no current may be applied to the other channel. If 350mA is applied to one channel, then a maximum of 130mA can be applied to the other channel.
 Example for BXRV-TR-27xxG-10A0-A-2x: If 700mA is applied to one channel, no current may be applied to the other channel. If 350mA is applied to one channel, then a maximum of 350mA can be applied to the other channel.
- Bridgelux recommends a maximum duty cycle of 10% and pulse width of 20ms when operating LED arrays at the maximum peak pulsed current specified. Maximum peak pulsed currents indicate values where the LED array can be driven without catastrophic failures.

Performance Curves

Figure 5: Forward Voltage vs. Forward Current, $T_c=25^\circ\text{C}$

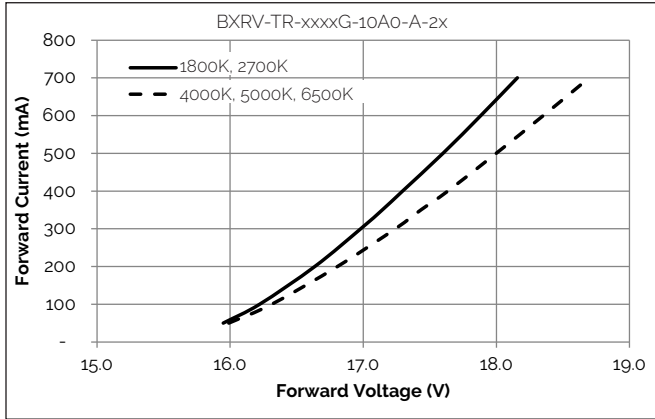

Figure 6: Forward Voltage vs. Forward Current, $T_c=25^\circ\text{C}$

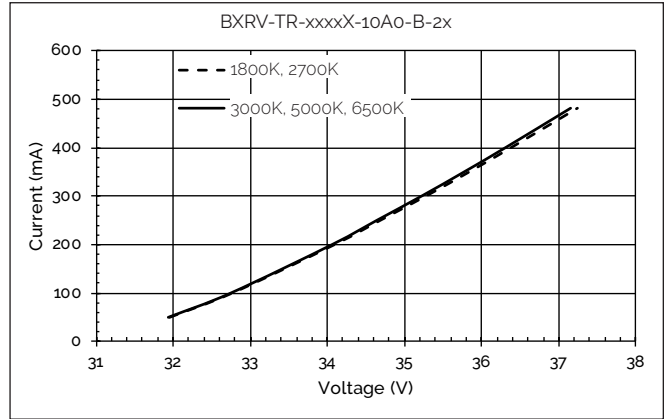

Figure 7: Relative Flux vs. Drive Current, $T_c=25^\circ\text{C}$

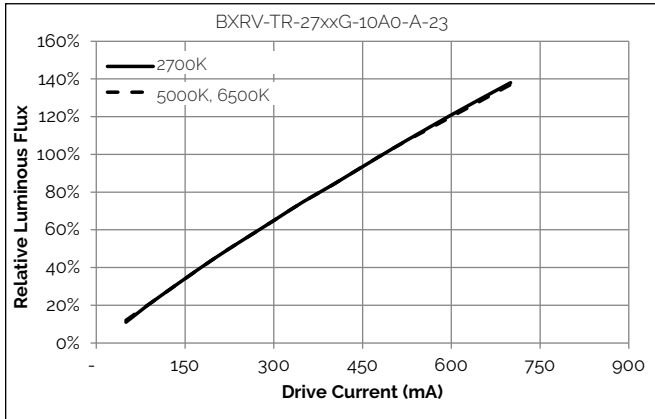

Figure 8: Relative Flux vs. Drive Current, $T_c=25^\circ\text{C}$

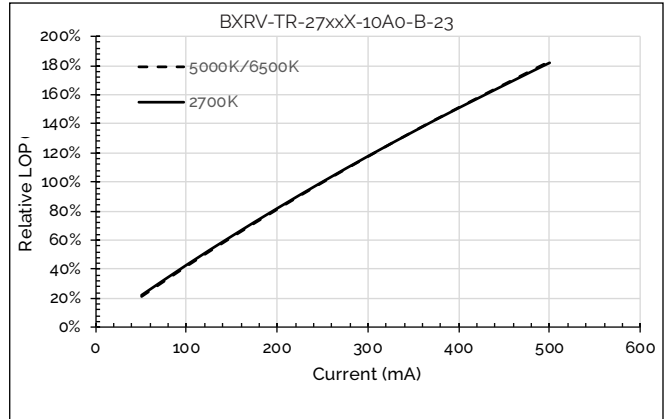

Figure 9: Relative Flux vs. Drive Current, $T_c=25^\circ\text{C}$

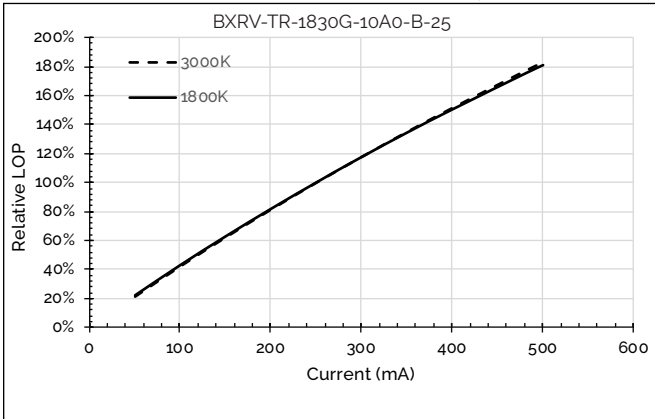
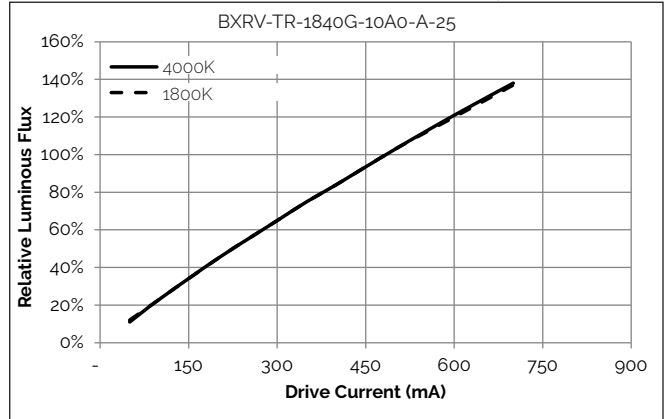

Figure 10: Relative Flux vs. Drive Current, $T_c=25^\circ\text{C}$



Performance Curves

Figure 11: Relative Flux vs. Case Temperature

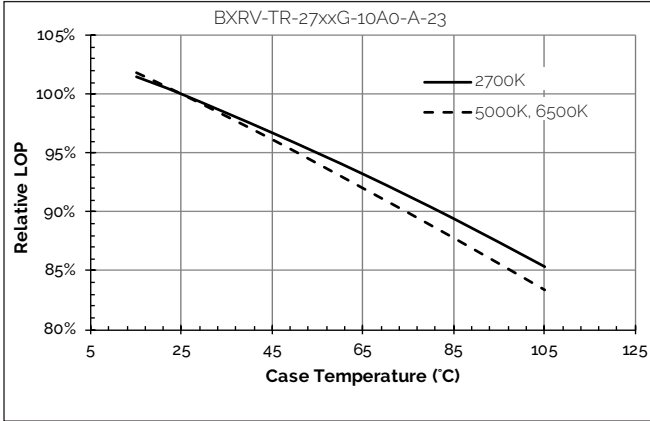

Figure 12: Relative Flux vs. Case Temperature

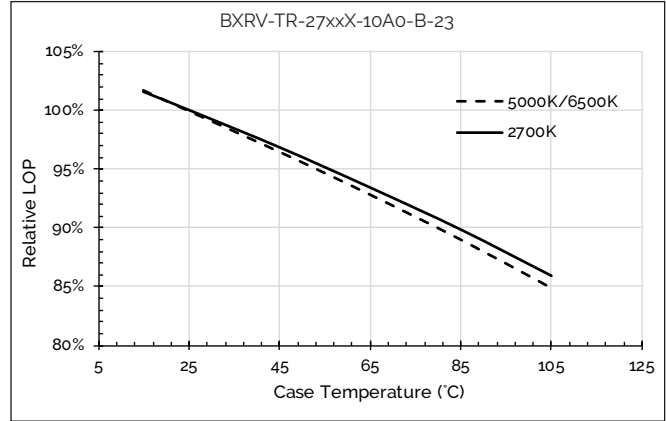

Figure 13: Relative Flux vs. Case Temperature

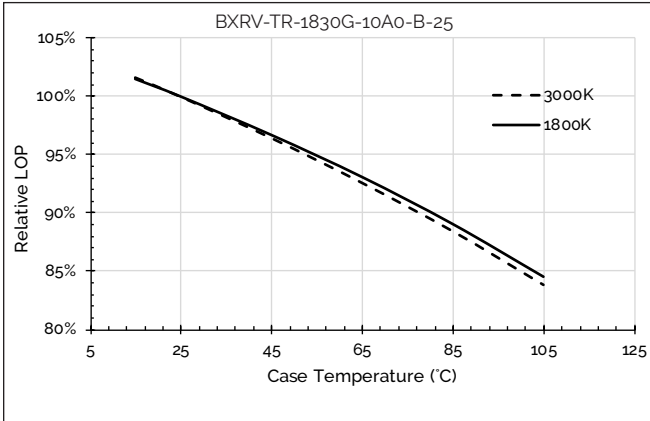
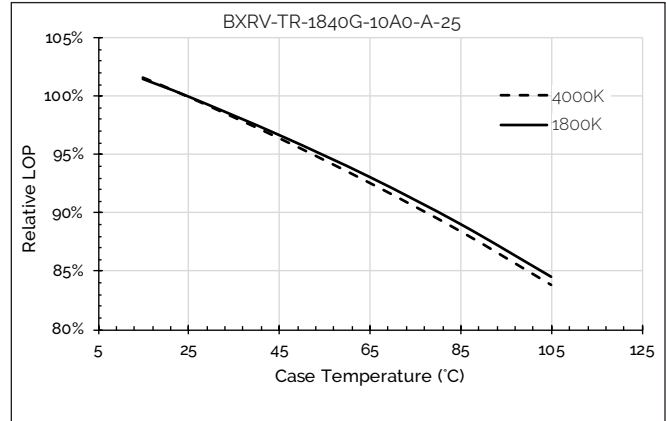

Figure 14: Relative Flux vs. Case Temperature



Performance Curves

Figure 15: Relative Voltage vs. Case Temperature

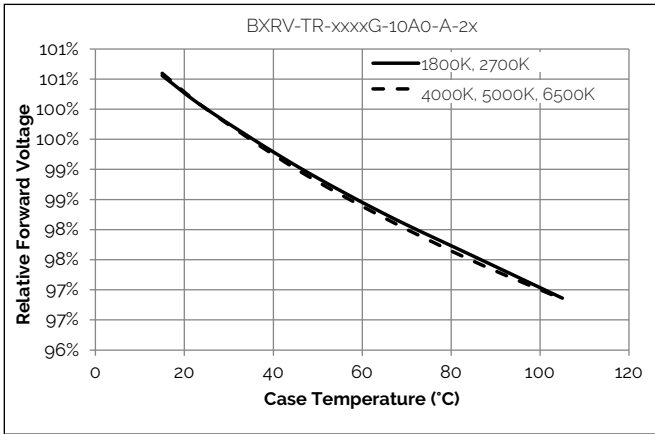

Figure 16: Relative Voltage vs. Case Temperature

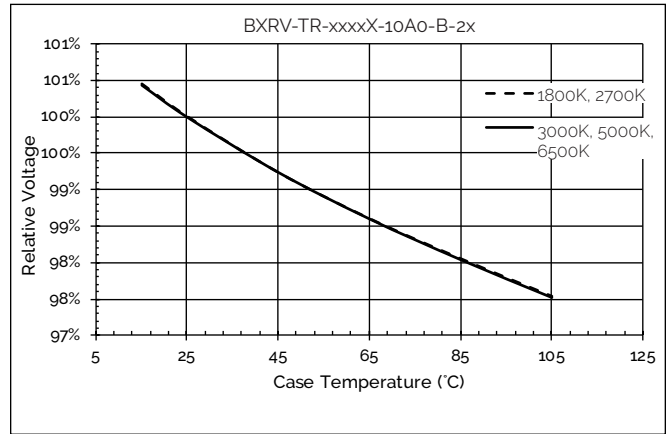

Figure 17: CCT vs. Relative Current, Tc=85C

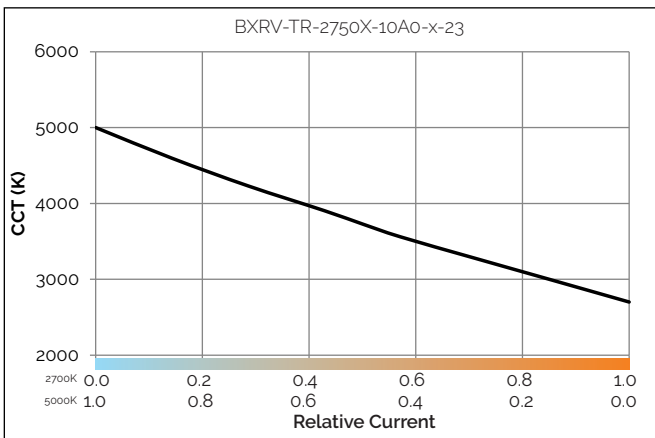

Figure 18: CCT vs. Relative Current, Tc=85C

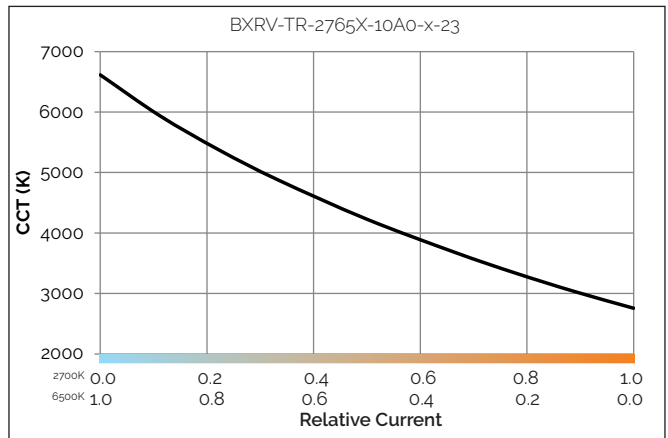

Figure 19: CCT vs. Relative Current, Tc=85C

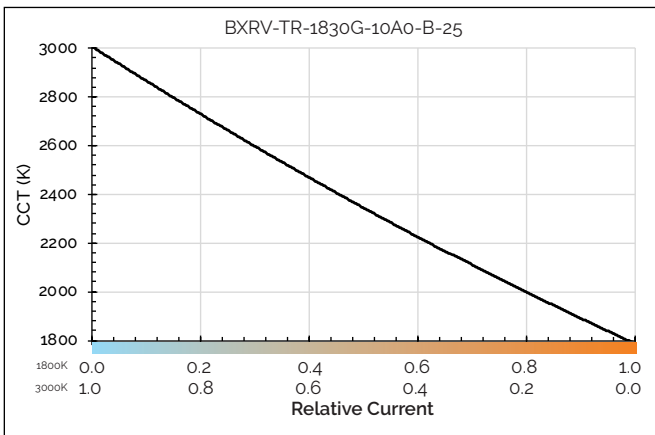
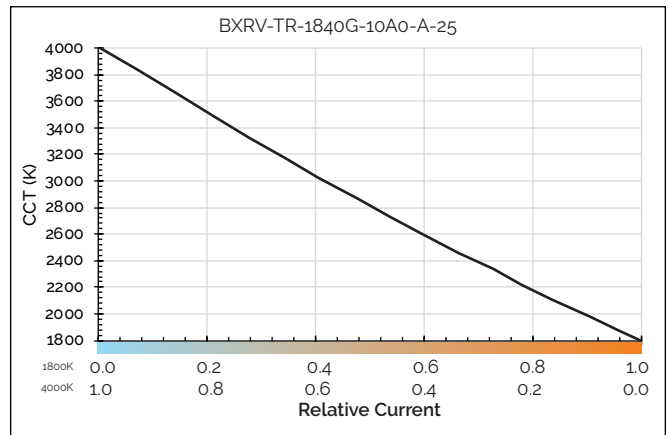

Figure 20: CCT vs. Relative Current, Tc=85C



Performance Curves

Figure 21: CCT Tuning Range, Tc=85C

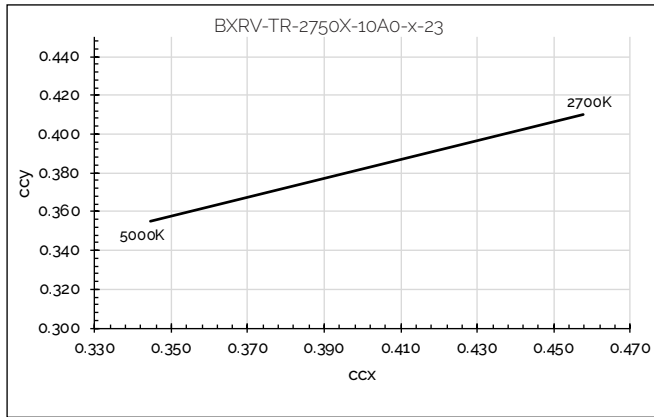

Figure 22: CCT Tuning Range, Tc=85C

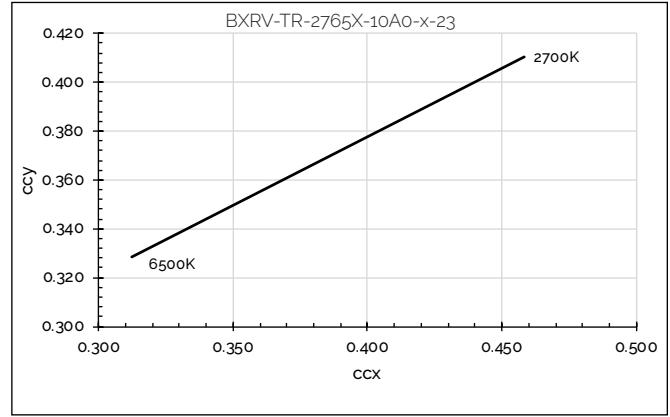

Figure 23: CCT Tuning Range, Tc=85C

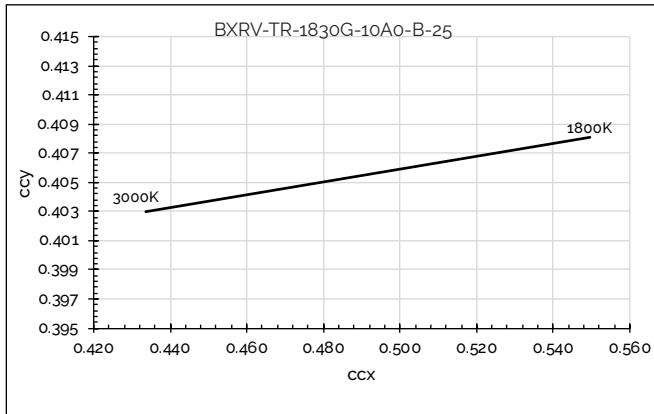
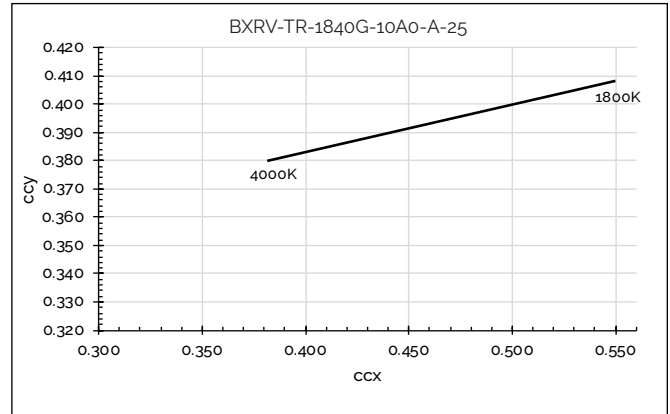

Figure 24: CCT Tuning Range, Tc=85C



Performance Curves

Figure 25: Relative Flux vs. Relative Current

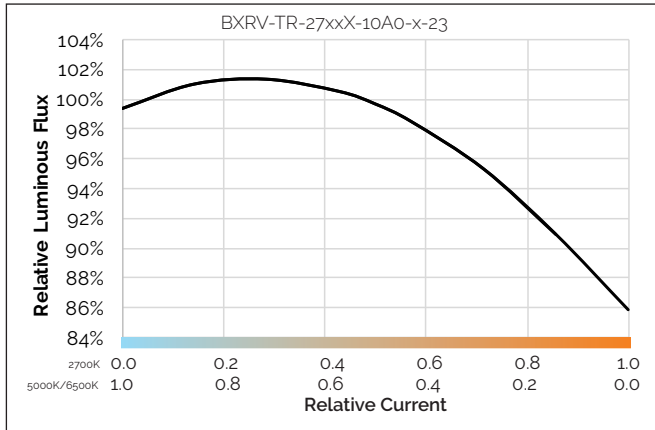

Figure 26: Relative Flux vs. Relative Current

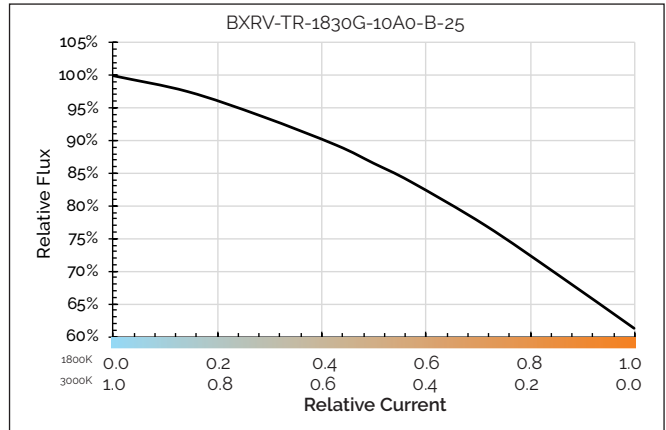
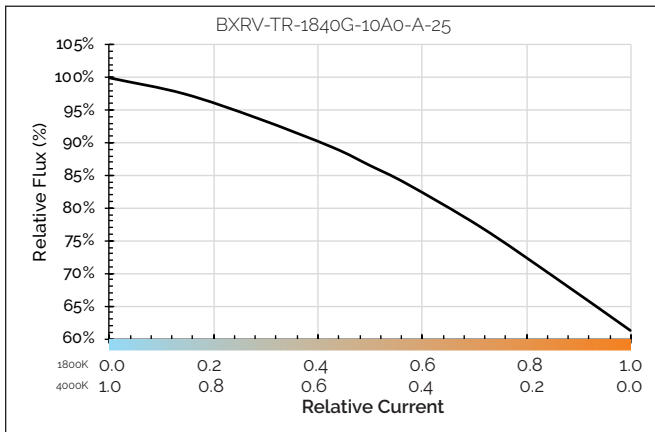
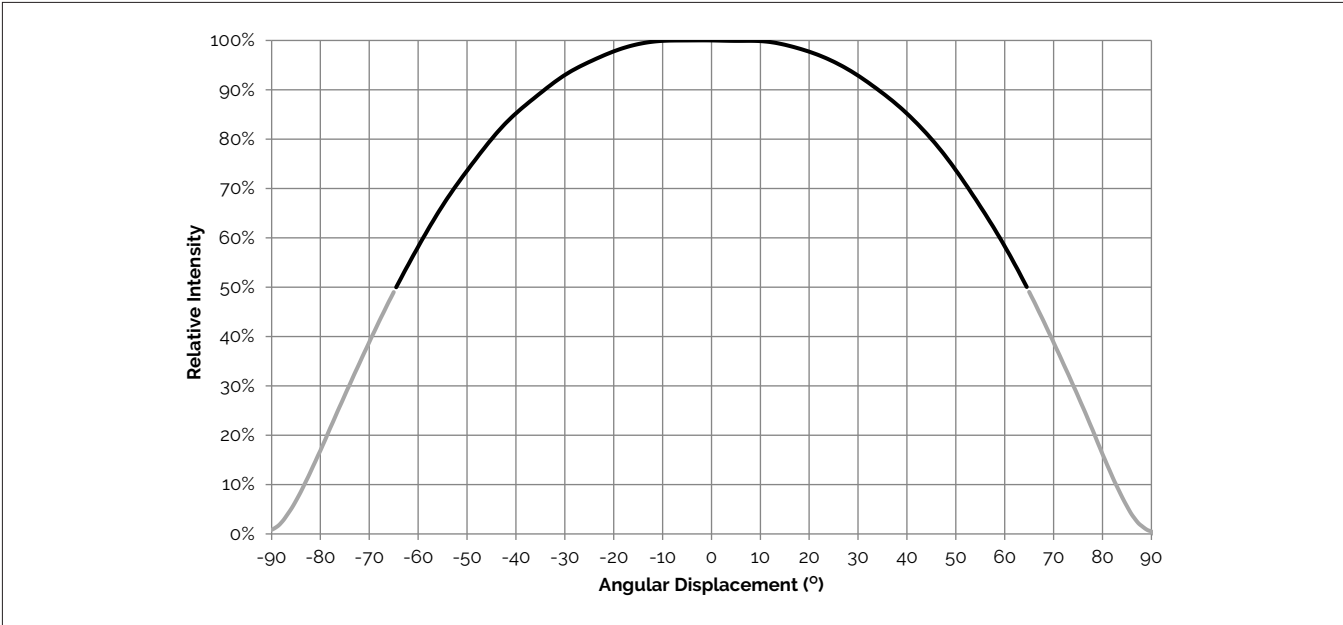

Figure 27: Relative Flux vs. Relative Current



Typical Radiation Pattern

Figure 28: Typical Spatial Radiation Pattern



Notes for Figure 28:

- 1. Typical viewing angle is 130°.
- 2. The viewing angle is defined as the off axis angle from the centerline where I_v is ½ of the peak value.

Figure 29: Typical Polar Radiation Pattern

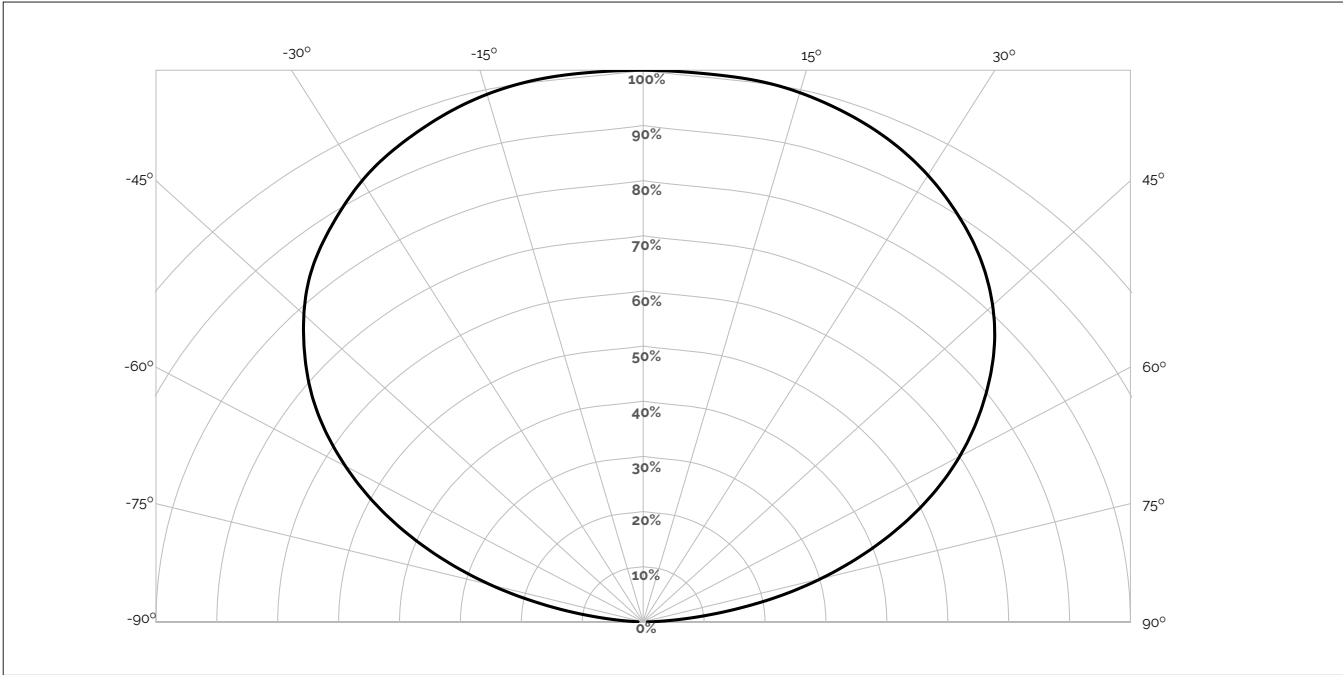

Typical Color Spectrum

Figure 30: 2700K - 5000K with Thrive

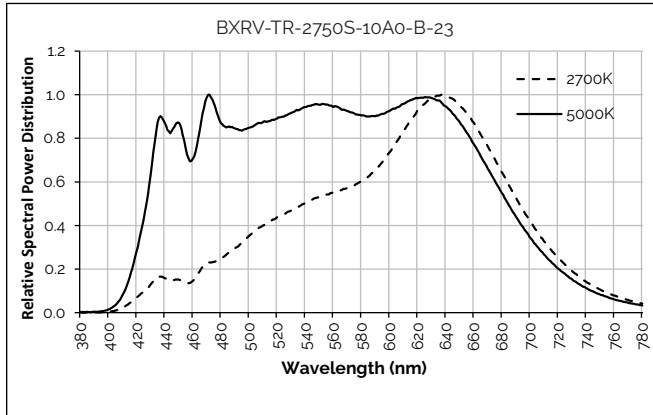

Note for Figure 30:

1. Color spectra measured at nominal current and $T_c = 85^\circ\text{C}$.

Figure 31: 2700K - 6500K with Thrive

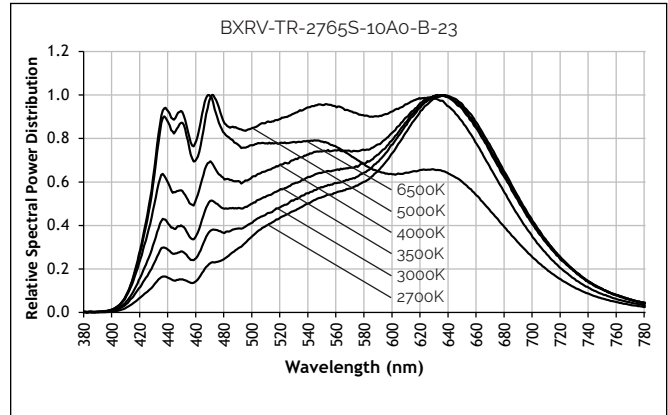

Note for Figure 31:

1. Color spectra measured at nominal current and $T_c = 85^\circ\text{C}$.

Figure 32: 2700K - 5000K with 90 CRI

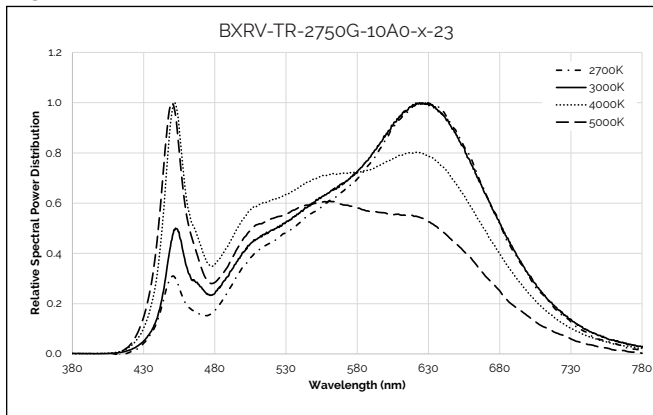

Note for Figure 32:

1. Color spectra measured at nominal current and $T_c = 25^\circ\text{C}$.

Figure 33: 2700K - 6500K with 90 CRI

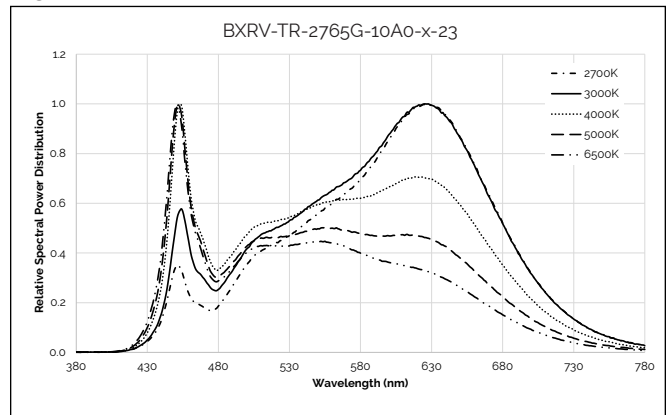

Note for Figure 33:

1. Color spectra measured at nominal current and $T_c = 25^\circ\text{C}$.

Figure 34: 1800K - 3000K with 90 CRI

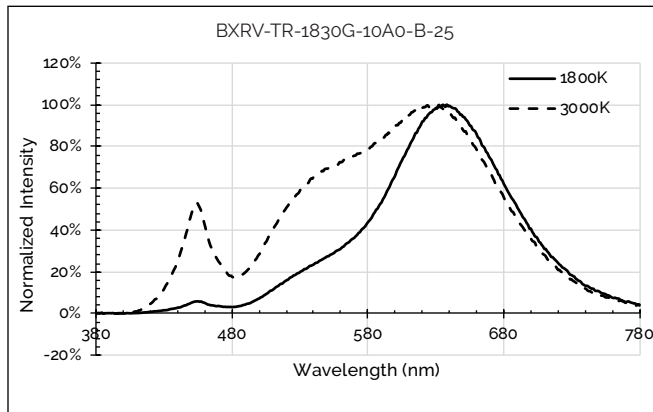

Note for Figure 34:

1. Color spectra measured at nominal current and $T_c = 25^\circ\text{C}$.

Figure 35: 1800K - 4000K with 90 CRI

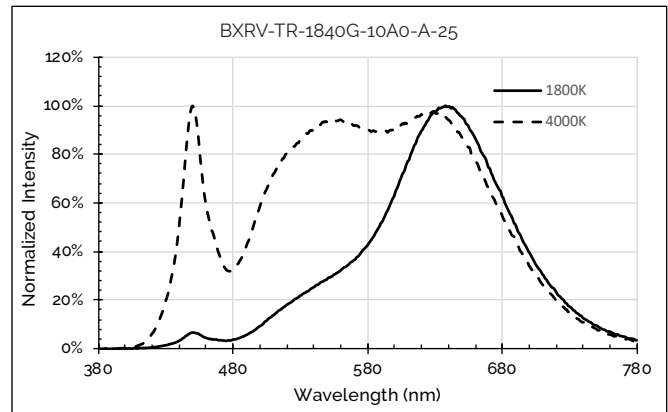

Note for Figure 35:

1. Color spectra measured at nominal current and $T_c = 25^\circ\text{C}$.

Mechanical Dimensions

Figure 36: Drawing for Vesta Series Tunable White Gen2 gmm Array

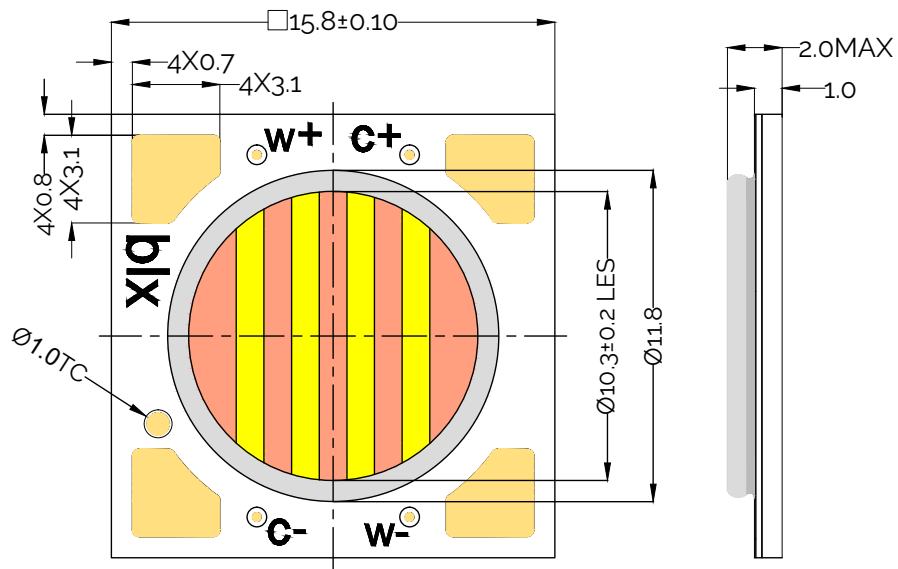

Notes for Figure 36:

1. Solder pads are labeled "+" to denote positive polarity and "-" to denote negative polarity. Solder pads have a gold surface finish.
2. Drawings are not to scale.
3. Drawing dimensions are in millimeters.
4. Unless otherwise specified, tolerances are ± 0.10 mm.
5. The optical center of the LED array is nominally defined by the mechanical center of the array.
6. Bridgelux maintains a flatness of 0.1 mm across the mounting surface of the array. Refer to Application Notes for product handling, mounting and heat sink recommendations.

Color Binning Information

Figure 37: Graph of Bins in xy Color Space, Tc=85°C

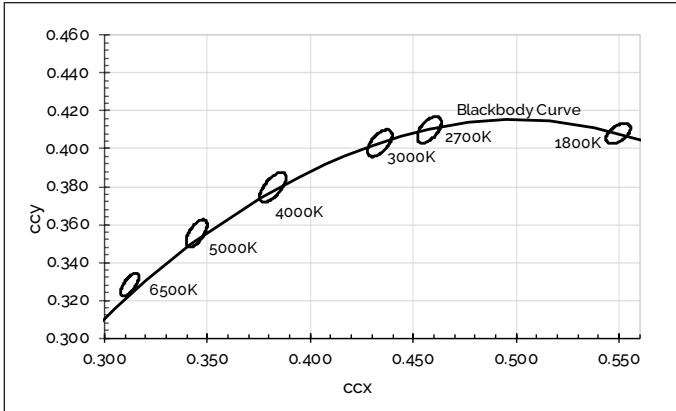

Table 6: McAdam ellipse CCT color bin definitions for product operating at T_c = 85°C

CCT	Center Point	Bin Size	Axis a	Axis b	Rotation Angle
2700K	x=0.4578 y= 0.4101	3 SDCM	0.00810	0.00420	53.70°
5000K	x=0.3447 y=0.3553	3 SDCM	0.00822	0.00354	59.62°
6500K	x=0.3123 y=0.3282	3 SDCM	0.00690	0.00285	58.57°
1800K	x=0.5496 y=0.4081	5SDCM	0.01164	0.00655	40.00°
3000K	x=0.4338 y=0.4030	3SDCM	0.00834	0.00408	53.22°
4000K	x=0.3818 y=0.3797	3SDCM	0.00939	0.00402	53.72°

Notes for Table 6:

1. The x,y center points are the center points of the respective ANSI bins in the CIE 1931 xy Color Space
2. Products are binned at T_c=85°C
3. Bridgelux maintains a tolerance of +/-0.007 on x and y color coordinates in the CIE 1931 Color Space

Figure 38: Definition of the McAdam ellipse

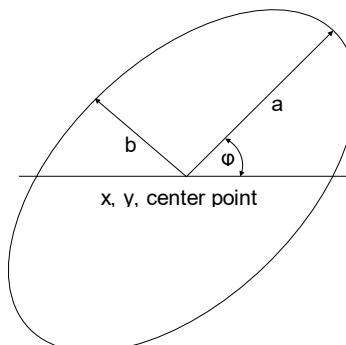

Packaging and Labeling

Figure 39: Vesta Series Tunable White 9mm Packaging and Labeling

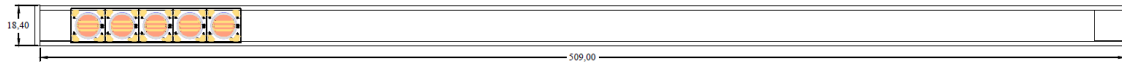

Tube label

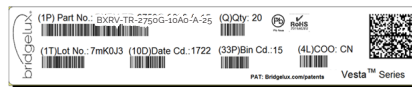

Bag label



Box label

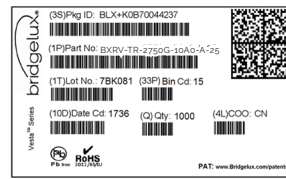

Notes for Figure 39

1. Each tube holds 30 Vesta Series Tunable White 9mm arrays.
2. Four tubes are sealed in an anti-static bag. Up to five such bags are placed in a box and shipped. Depending on quantities ordered, a bigger shipping box, containing four boxes will be used to ship products.
3. Each bag and box is to be labeled as shown above.
4. Dimensions for each tube are 509.0 mm (L) x 18.4 mm (W) x 9.5 mm (H). Dimensions for the anti-static bag are 100.0 mm (W) x 625.0 mm (L) x 0.1 mm (T) and that of the inner box are 58.7 mm (L) x 13.3 mm (W) x 7.9 mm (H).

Design Resources

Application Notes

Vesta Series Tunable White arrays are intended for use in dry, indoor applications. Bridgelux has developed a comprehensive set of application notes and design resources to assist customers in successfully designing with the Vesta Series product family of LED array products. For a list of resources under development, visit www.bridgelux.com.

Optical Source Models

Optical source models and ray set files are available for all Bridgelux products. For a list of available formats, visit www.bridgelux.com.

3D CAD Models

Three dimensional CAD models depicting the product outline of all Bridgelux Vesta Series LED arrays are available in both IGS and STEP formats. Please contact your Bridgelux sales representative for assistance.

LM80

Please contact your Bridgelux sales representative for more information.

Precautions

CAUTION: CHEMICAL EXPOSURE HAZARD

Exposure to some chemicals commonly used in luminaire manufacturing and assembly can cause damage to the LED array. Please consult Bridgelux Application Notes, ANg2, ANg3 and AN101 for additional information.

CAUTION: EYE SAFETY

Eye safety classification for the use of Bridgelux Vesta Series is in accordance with IEC/TR62778 specification, 'application of IEC 62471 for the assessment of blue light hazard to light source and luminaires'. Vesta Series Tunable White arrays are classified as Risk Group 1 when operated at or below the maximum drive current. Please use appropriate precautions. It is important that employees working with LEDs are trained to use them safely.

CAUTION: RISK OF BURN

Do not touch the Vesta Series LED array during operation. Allow the array to cool for a sufficient period of time before handling. The Vesta Series LED array may reach elevated temperatures such that could burn skin when touched.

CAUTION

CONTACT WITH LIGHT EMITTING SURFACE (LES)

Avoid any contact with the LES. Do not touch the LES of the LED array or apply stress to the LES (yellow phosphor resin area). Contact may cause damage to the LED array.

Optics and reflectors must not be mounted in contact with the LES (yellow phosphor resin area). Optical devices may be mounted on the top surface of the Vesta Series LED array. Use the mechanical features of the LED array housing, edges and/or mounting holes to locate and secure optical devices as needed.

Disclaimers

STANDARD TEST CONDITIONS

Unless otherwise stated, array testing is performed at the nominal drive current.

MINOR PRODUCT CHANGE POLICY

The rigorous qualification testing on products offered by Bridgelux provides performance assurance. Slight cosmetic changes that do not affect form, fit, or function may occur as Bridgelux continues product optimization.

About Bridgelux: Bridging Light and Life™

At Bridgelux, we help companies, industries and people experience the power and possibility of light. Since 2002, we've designed LED solutions that are high performing, energy efficient, cost effective and easy to integrate. Our focus is on light's impact on human behavior, delivering products that create better environments, experiences and returns—both experiential and financial. And our patented technology drives new platforms for commercial and industrial luminaires.

For more information about the company, please visit
bridgelux.com
twitter.com/Bridgelux
facebook.com/Bridgelux
youtube.com/user/Bridgelux
linkedin.com/company/bridgelux-inc-_2
WeChat ID: BridgeluxInChina



46430 Fremont Blvd
Fremont, CA 94538 USA
Tel (925) 583-8400
www.bridgelux.com

© 2020 Bridgelux, Inc. All rights reserved 2020. Product specifications are subject to change without notice. Bridgelux, the Bridgelux stylized logo design and Vesta are registered trademarks of Bridgelux, Inc. All other trademarks are the property of their respective owners.

Bridgelux Vesta Series Tunable White Gen 2 9mm Array Product Data Sheet DS350 Rev. F (06/2020)