



Bridgelux® V8 F90 Array Series

Product Data Sheet DS445



Introduction

V Series



The V Series™ LED Array products deliver high quality light in a compact and cost-effective solid-state lighting package. These chip on board (CoB) arrays can be efficiently driven up to two times the nominal drive current, enabling design flexibility not previously possible. These high flux density light sources are designed to support a wide range of high quality, low cost directional luminaires and replacement lamps for both interior and exterior commercial and residential applications.

The F90 V Series COB is a high efficacy product that uses narrow band red phosphor to significantly improve the spectrum efficacy. The improved spectrum efficacy results in the 90 CRI product of the F90 Series delivering better or equivalent efficacy as that of our traditional 80 CRI V Series product.

The V8 LED Array is available in a variety of electrical, CCT, and CRI combinations providing substantial design flexibility and energy efficiency advantages.

Lighting system designs incorporating these LED arrays deliver increased system level efficacy and a longer service life. Typical applications include replacement lamps and task, accent, spot, track, wide area, security, wall packs and down lights.

Features

- Efficacy of 182 lm/W typical, 3000K 90 CRI
- Wide selection of CCT options (2700K-5000K) with minimum 90 CRI options
- Uniform high-quality illumination
- 2 and 3 SDCM binning options (2700K – 4000K)
- 3 and 4 SDCM binning options (5000K)
- Forward voltage bin codes and backside marking
- Instant light with unlimited dimming
- 5-Year warranty

Benefits

- Enables high efficiency lighting systems and lower operating costs
- Supports the trend toward luminaire miniaturization and delivers enhanced optical control
- Design flexibility for a broad range of lighting applications
- Clean white light without pixelation
- Uniform consistent white light
- Design flexibility for multi-source applications
- Easy to use with daylight and motion sensors to increase energy savings
- Design with confidence



Contents

Product Feature Map	2
Product Nomenclature	2
Product Selection Guide	3
European Product Registry for Energy Labeling	5
Performance at Commonly Used Drive Currents	6
Electrical Characteristics	8
Eye Safety	9
Absolute Maximum Ratings	10
Performance Curves	11
Typical Radiation Pattern	13
Typical Color Spectrum	14
Mechanical Dimensions	15
Color Binning Information	16
Packaging and Labeling	17
Design Resources	19
Precautions	19
Disclaimers	19
About Bridgelux	20

Product Feature Map

Bridgelux arrays are fully engineered devices that provide consistent thermal and optical performance on an engineered mechanical platform. The V Series arrays are the most compact CoB devices across all of Bridgelux's LED Array products.

The arrays incorporate several features to simplify design integration and assembly. Please visit www.bridgelux.com for more information on the V Series family of products.

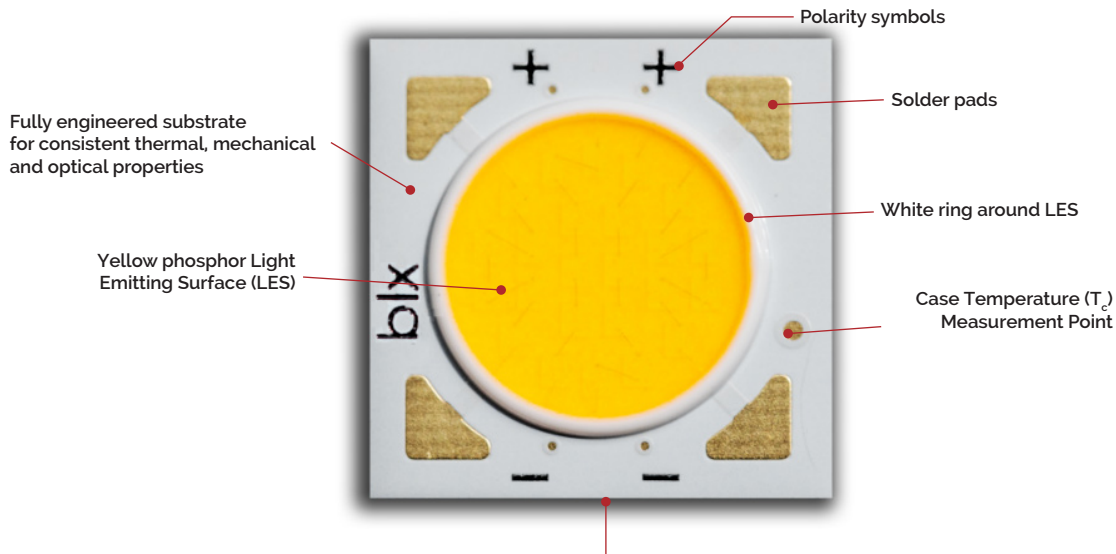

Note: Part number and lot codes are scribed on back of array

Product Nomenclature

The part number designation for Bridgelux V Series LED arrays is explained as follows:

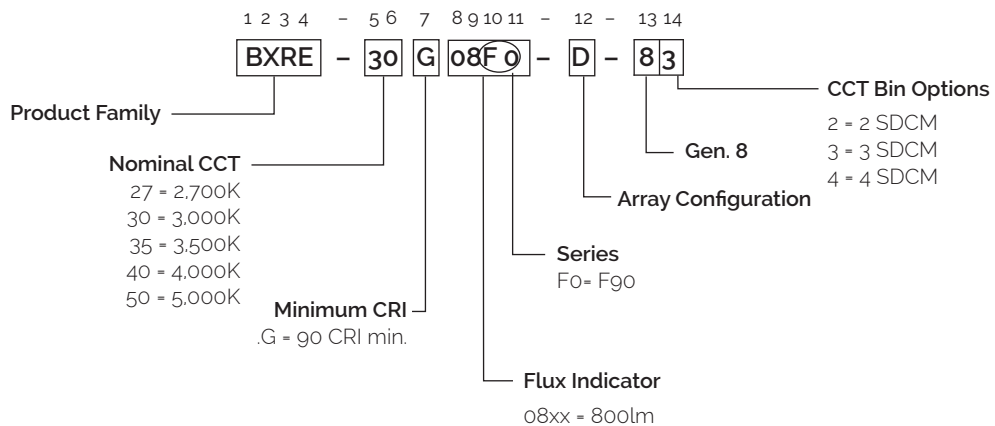

Product Selection Guide

The following product configurations are available:

Table 1: Selection Guide, Pulsed Measurement Data ($T_j = T_c = 25^\circ\text{C}$)

Part Number	Nominal CCT ¹ (K)	CRI ²	Nominal Drive Current ³ (mA)	Typical Pulsed Flux ^{4,5,6} $T_c = 25^\circ\text{C}$ (lm)	Minimum Pulsed Flux ^{6,7} $T_c = 25^\circ\text{C}$ (lm)	Typical V_f (V)	Typical Power (W)	Typical Efficacy (lm/W)
BXRE-27Go8Fo-D-8x	2700	90	300	922	830	17.2	5.2	178
BXRE-27Go8Fo-E-8x	2700	90	150	922	830	34.5	5.2	178
BXRE-30Go8Fo-D-8x	3000	90	300	941	847	17.2	5.2	182
BXRE-30Go8Fo-E-8x	3000	90	150	941	847	34.5	5.2	182
BXRE-35Go8Fo-D-8x	3500	90	300	951	855	17.2	5.2	184
BXRE-35Go8Fo-E-8x	3500	90	150	951	855	34.5	5.2	184
BXRE-40Go8Fo-D-8x	4000	90	300	960	864	17.2	5.2	186
BXRE-40Go8Fo-E-8x	4000	90	150	960	864	34.5	5.2	186
BXRE-50Go8Fo-D-8x	5000	90	300	932	839	17.2	5.2	180
BXRE-50Go8Fo-E-8x	5000	90	150	932	839	34.5	5.2	180

Notes for Table 1:

- Nominal CCT as defined by ANSI C78.377-2011.
- CRI values are minimums and tested at $T_j = T_c = 85^\circ\text{C}$. Minimum R_g value for 90 CRI products is 50. Bridgelux maintains a ± 3 tolerance on CRI and R_g values.
- Drive current is referred to as nominal drive current.
- Products tested under pulsed condition (10ms pulse width) at nominal test current where T_j (junction temperature) = T_c (case temperature) = 25°C .
- Typical performance values are provided as a reference only and are not a guarantee of performance.
- Bridgelux maintains a $\pm 7\%$ tolerance on flux measurements.
- Minimum flux values at the nominal test current are guaranteed by 100% test.

Product Selection Guide

Table 2: Selection Guide, Stabilized DC Performance ($T_c = 85^\circ\text{C}$)

Part Number	Nominal CCT ¹ (K)	CRI ²	Nominal Drive Current ³ (mA)	Typical DC Flux ^{4,5} $T_c = 85^\circ\text{C}$ (lm)	Minimum DC Flux ⁶ $T_c = 85^\circ\text{C}$ (lm)	Typical V_f (V)	Typical Power (W)	Typical Efficacy (lm/W)
BXRE-27G08F0-D-8x	2700	90	300	849	764	16.9	5.1	167
BXRE-27G08F0-E-8x	2700	90	150	849	764	33.7	5.1	168
BXRE-30G08F0-D-8x	3000	90	300	866	779	16.9	5.1	171
BXRE-30G08F0-E-8x	3000	90	150	866	779	33.7	5.1	171
BXRE-35G08F0-D-8x	3500	90	300	874	787	16.9	5.1	172
BXRE-35G08F0-E-8x	3500	90	150	874	787	33.7	5.1	173
BXRE-40G08F0-D-8x	4000	90	300	883	795	16.9	5.1	174
BXRE-40G08F0-E-8x	4000	90	150	883	795	33.7	5.1	175
BXRE-50G08F0-D-8x	5000	90	300	857	771	16.9	5.1	169
BXRE-50G08F0-E-8x	5000	90	150	857	771	33.7	5.1	170

Notes for Table 2:

- Nominal CCT as defined by ANSI C78.377-2011.
- CRI values are minimums and tested at $T_j = T_c = 85^\circ\text{C}$. Minimum Rg value for 90 CRI products is 50.
- Drive current is referred to as nominal drive current.
- Typical stabilized DC performance values are provided as reference only and are not a guarantee of performance.
- Typical performance is estimated based on operation under DC (direct current) with LED array mounted onto a heat sink with thermal interface material and the case temperature maintained at 85°C . Based on Bridgelux test setup, values may vary depending on the thermal design of the luminaire and/or the exposed environment to which the product is subjected.
- Minimum flux values at elevated temperatures are provided for reference only and are not guaranteed by 100% production testing. Based on Bridgelux test setup, values may vary depending on the thermal design of the luminaire and/or the exposed environment to which the product is subjected.

European Product Registry for Energy Labeling

The European Product Registry for Energy Labeling (EPREL) is defined in the EU Regulation 2017/1369 to provide important energy efficiency information to consumers. Together with Energy Labeling Regulation ELR (EU) 2019/2015 which was amended by regulation (EU) 2021/340 for energy labelling of light sources, manufacturers are required to declare an energy class based on key technical specifications from each of their product and register it in an open data base managed by EPREL. It is now a legal requirement for a vendor of light sources to upload information about their products into the EPREL database before placing these products on the market in the EU.

Table 3 below provides a list of part numbers that are in compliance with ELR and are currently listed in the EPREL database.

At Bridgelux, we are fully committed to supplying products that are compliant with pertinent laws, rules, and obligation imposed by relevant government bodies including the European Energy Labeling regulation. Customers can use these products with full confidence for any projects that fall under the ELR.

Table 3: Part numbers registered in European Product Registry for Energy Labeling

PART NUMBER ¹	CCT (K)	CRI	Current ² (mA)	Vf (V)	Useful flux ³ (Φ_{use}) at 85C (lm)	Power (W)	Efficacy (lm/W)	Energy efficiency class ⁴	Registration No	URL to Product Information Sheet in EPREL Database
BXRE-27Go8Fo-D-83	2700	90	720	19.0	1800	13.7	132	E	1168449	https://eprelec.europa.eu/qr/1168449
BXRE-27Go8Fo-E-83	2700	90	360	38.0	1800	13.7	132	E	1168450	https://eprelec.europa.eu/qr/1168450
BXRE-30Go8Fo-D-83	3000	90	720	19.0	1837	13.7	134	E	1168456	https://eprelec.europa.eu/qr/1168456
BXRE-30Go8Fo-E-83	3000	90	360	38.0	1837	13.7	134	E	1168457	https://eprelec.europa.eu/qr/1168457
BXRE-35Go8Fo-D-83	3500	90	720	19.0	1855	13.7	136	E	1168461	https://eprelec.europa.eu/qr/1168461
BXRE-35Go8Fo-E-83	3500	90	360	38.0	1855	13.7	136	E	1168462	https://eprelec.europa.eu/qr/1168462
BXRE-40Go8Fo-D-83	4000	90	720	19.0	1873	13.7	137	E	1168468	https://eprelec.europa.eu/qr/1168468
BXRE-40Go8Fo-E-83	4000	90	360	38.0	1873	13.7	137	E	1168469	https://eprelec.europa.eu/qr/1168469
BXRE-50Go8Fo-D-84	5000	90	720	19.0	1818	13.7	133	E	1168475	https://eprelec.europa.eu/qr/1168475
BXRE-50Go8Fo-E-84	5000	90	360	38.0	1818	13.7	133	E	1168476	https://eprelec.europa.eu/qr/1168476

Notes for Table 3:

1. All device listed here must be disposed as e-waste upon its end of life according to local country guideline in each country.
2. For information on performance values at alternative drive conditions, please refer to the Product Selection Guide, Absolute Maximum Rating Table and Performance Curves in this data sheet.
3. For a definition of useful luminous flux (Φ_{use}), please see the ELR regulations at <https://tinyurl.com/4b6zvt4m>.
4. EPREL requires an arrow symbol containing the letter of the energy efficiency class to be displayed, on technical promotional material. Refer to this energy efficiency class column for specific energy efficiency class on each part number.

Performance at Commonly Used Drive Currents

V Series LED arrays are tested to the specifications shown using the nominal drive currents in Table 1. V Series may also be driven at other drive currents dependent on specific application design requirements. The performance at any drive current can be derived from the current vs. voltage characteristics shown in Figures 1 and 2 and the flux vs. current characteristics shown in Figures 3 and 4. The performance at commonly used drive currents is summarized in Table 4.

Table 4: Product Performance at Commonly Used Drive Currents

Part Number	CRI	Drive Current ¹ (mA)	Typical V_f $T_c = 25^\circ\text{C}$ (V)	Typical Power $T_c = 25^\circ\text{C}$ (W)	Typical Flux ² $T_c = 25^\circ\text{C}$ (lm)	Typical DC Flux ³ $T_c = 85^\circ\text{C}$ (lm)	Typical Efficacy $T_c = 25^\circ\text{C}$ (lm/W)
BXRE-27G08F0-D-8x	90	150	16.6	2.5	480	445	193
		225	16.9	3.8	704	650	185
		300	17.2	5.2	922	849	178
		518	18.1	9.4	1527	1382	163
		619	18.5	11.4	1792	1606	157
		720	18.8	13.6	2047	1815	151
BXRE-27G08F0-E-8x	90	75	33.2	2.5	482	447	194
		110	33.8	3.7	691	639	186
		150	34.5	5.2	922	849	178
		175	34.9	6.1	1069	980	175
		250	36.1	9.0	1484	1345	165
		360	37.7	13.6	2054	1821	152
BXRE-30G08F0-D-8x	90	150	16.6	2.5	490	454	197
		225	16.9	3.8	718	664	189
		300	17.2	5.2	941	866	182
		518	18.1	9.4	1558	1410	166
		619	18.5	11.4	1829	1639	160
		720	18.8	13.6	2089	1852	154
BXRE-30G08F0-E-8x	90	75	33.2	2.5	491	456	198
		110	33.8	3.7	706	652	190
		150	34.5	5.2	941	866	182
		175	34.9	6.1	1090	1000	179
		250	36.1	9.0	1514	1372	168
		360	37.7	13.6	2096	1859	155
BXRE-35G08F0-D-8x	90	150	16.6	2.5	495	459	199
		225	16.9	3.8	725	670	191
		300	17.2	5.2	951	874	184
		518	18.1	9.4	1574	1424	168
		619	18.5	11.4	1847	1655	161
		720	18.8	13.6	2110	1871	156
BXRE-35G08F0-E-8x	90	75	33.2	2.5	496	461	200
		110	33.8	3.7	713	659	192
		150	34.5	5.2	951	874	184
		175	34.9	6.1	1101	1010	180
		250	36.1	9.0	1529	1386	170
		360	37.7	13.6	2117	1877	156

Notes for Table 4:

1. Alternate drive currents in Table 4 are provided for reference only and are not a guarantee of performance.
2. Bridgelux maintains a $\pm 7\%$ tolerance on flux measurements.
3. Typical stabilized DC performance values are provided as reference only and are not a guarantee of performance.

Performance at Commonly Used Drive Currents

Table 4: Product Performance at Commonly Used Drive Currents (continued)

Part Number	CRI	Drive Current ¹ (mA)	Typical V_f $T_c = 25^\circ\text{C}$ (V)	Typical Power $T_c = 25^\circ\text{C}$ (W)	Typical Flux ² $T_c = 25^\circ\text{C}$ (lm)	Typical DC Flux ³ $T_c = 85^\circ\text{C}$ (lm)	Typical Efficacy $T_c = 25^\circ\text{C}$ (lm/W)
BXRE-40G08F0-D-8x	90	150	16.6	2.5	500	464	201
		225	16.9	3.8	733	677	193
		300	17.2	5.2	960	883	186
		518	18.1	9.4	1589	1438	169
		619	18.5	11.4	1865	1671	163
		720	18.8	13.6	2131	1889	157
BXRE-40G08F0-E-8x	90	75	33.2	2.5	501	465	202
		110	33.8	3.7	720	665	194
		150	34.5	5.2	960	883	186
		175	34.9	6.1	1112	1020	182
		250	36.1	9.0	1545	1400	171
		360	37.7	13.6	2138	1896	158
BXRE-50G08F0-D-8x	90	150	16.6	2.5	485	450	195
		225	16.9	3.8	711	657	187
		300	17.2	5.2	932	857	180
		518	18.1	9.4	1543	1396	164
		619	18.5	11.4	1810	1622	158
		720	18.8	13.6	2068	1834	153
BXRE-50G08F0-E-8x	90	75	33.2	2.5	487	451	196
		110	33.8	3.7	698	646	188
		150	34.5	5.2	932	857	180
		175	34.9	6.1	1080	990	177
		250	36.1	9.0	1499	1358	166
		360	37.7	13.6	2075	1840	153

Notes for Table 4:

1. Alternate drive currents in Table 4 are provided for reference only and are not a guarantee of performance.
2. Bridgelux maintains a $\pm 7\%$ tolerance on flux measurements.
3. Typical stabilized DC performance values are provided as reference only and are not a guarantee of performance.

Electrical Characteristics

Table 5: Electrical Characteristics

Part Number	Drive Current (mA)	Forward Voltage Pulsed, $T_c = 25^\circ\text{C}$ (V) ^{1, 2, 3, 8}			Typical Coefficient of Forward Voltage ⁴ $\Delta V_f / \Delta T_c$ (mV/ $^\circ\text{C}$)	Typical Thermal Resistance Junction to Case ^{5,6} R_{j-c} ($^\circ\text{C}/\text{W}$)	Driver Selection Voltages ⁷ (V)	
		Minimum	Typical	Maximum			V_f Min. Hot $T_c = 95^\circ\text{C}$ (V)	V_f Max. Cold $T_c = -40^\circ\text{C}$ (V)
BXRE-xxx08F0-D-8x	300	16.2	17.2	18.3	-6.5	0.79	15.8	18.7
	720	17.7	18.8	20.0	-7.0	1.13	17.2	20.4
BXRE-xxx08F0-E-8x	150	32.4	34.5	36.5	-12.9	0.79	31.5	37.4
	360	35.4	37.7	39.9	-14.1	1.13	34.4	40.8

Notes for Table 5:

- Parts are tested in pulsed conditions, $T_c = 25^\circ\text{C}$. Pulse width is 10ms.
- Voltage minimum and maximum are provided for reference only and are not a guarantee of performance.
- Bridgelux maintains a tester tolerance of $\pm 0.10\text{V}$ on forward voltage measurements.
- Typical coefficient of forward voltage tolerance is $\pm 0.1\text{mV}$ for nominal current.
- Thermal resistance values are based from test data of a 3000K 90 CRI product.
- Thermal resistance value was calculated using total electrical input power; optical power was not subtracted from input power. The thermal interface material used during testing is not included in the thermal resistance value.
- V_f min hot and max cold values are provided as reference only and are not guaranteed by test. These values are provided to aid in driver design and selection over the operating range of the product.
- This product has been designed and manufactured per IEC 62031:2018. This product has passed dielectric withstand voltage testing at 1140 V. The working voltage designated for the insulation is 70V d.c. The maximum allowable voltage across the array must be determined in the end product application.

Eye Safety

Table 6: Eye Safety Risk Group (RG) Classifications

Part Number	Drive Current (mA)	CCT ⁴	
		2700K/3000K	3500-5000K ^{2,3}
BXRE-xxx08Fx-D-8x	575	RG1	RG1
	720	RG1	RG2
BXRE-xxx08Fx-E-8x	290	RG1	RG1
	360	RG1	RG2

Notes for Table 6:

1. Eye safety classification for the use of Bridgelux V Series LED arrays is in accordance with specification IEC/TR 62778: Application of IEC 62471 for the assessment of blue light hazard to light sources and luminaires.
2. For products classified as RG2 at 4000K, Ethr= 1980 lx.
3. For products classified as RG2 at 5000K Ethr= 1530 lx.
4. Please contact your Bridgelux sales representative for Ethr values at specific drive currents and CCTs not listed.

Absolute Maximum Ratings

Table 7: Maximum Ratings

Parameter	Maximum Rating	
LED Junction Temperature (T _J)	150°C	
Storage Temperature ¹	-40°C to +95°C	
Operating Case Temperature ² (T _C)	95°C	
Soldering Temperature ³	300°C or lower for a maximum of 6 seconds	
	BXRE-xxGo8Fo-D-8x	BXRE-xxGo8Fo-E-8x
Maximum Drive Current ⁴	720 mA at ≤85°C 540 mA at 95°C	360 mA at ≤85°C 270 mA at 95°C
Maximum Peak Pulsed Drive Current ⁵	1030 mA	510 mA
Maximum Reverse Voltage ⁶	-30V	-60V

Notes for Table 7:

1. The F90 product is robust enough to pass our internal humidity test but it is still more sensitive compared to regular LED array product. The product needs to be stored in a dry environment. It is not recommended to use the product in a damp environment that directly exposes it to moisture.
2. For IEC 62717 requirement, please consult your Bridgelux sales representative.
3. Refer to Bridgelux Application Note AN101: Handling and Assembly of Bridgelux V Series LED Arrays
4. Arrays may be driven at higher currents however lumen maintenance may be reduced and warranty will not apply.
5. Bridgelux recommends a maximum duty cycle of 10% and pulse width of 20 ms when operating LED Arrays at maximum peak pulsed current specified. Maximum peak pulsed currents indicate values where LED Arrays can be driven without catastrophic failures.
6. Light emitting diodes are not designed to be driven in reverse voltage and will not produce light under this condition. Maximum rating provided for reference only.

Performance Curves

Figure 1: V8D Drive Current vs. Voltage ($T_j = T_c = 25^\circ\text{C}$)¹

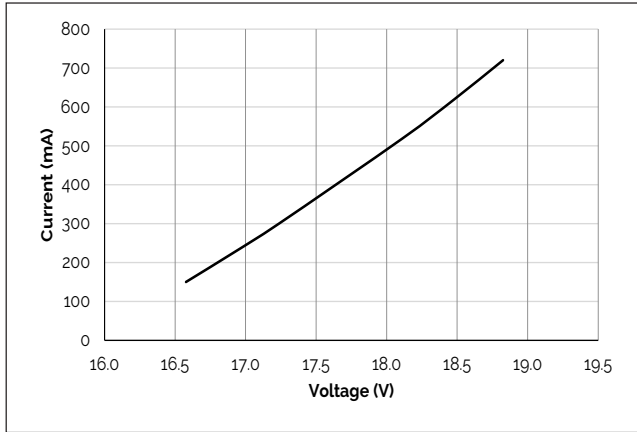

Figure 2: V8E Drive Current vs. Voltage ($T_j = T_c = 25^\circ\text{C}$)¹

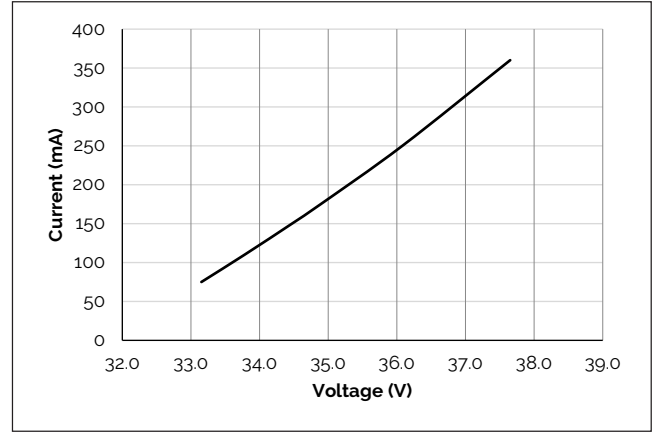

Figure 3: V8D Typical Relative Luminous Flux vs. Drive Current ($T_j = T_c = 25^\circ\text{C}$)¹

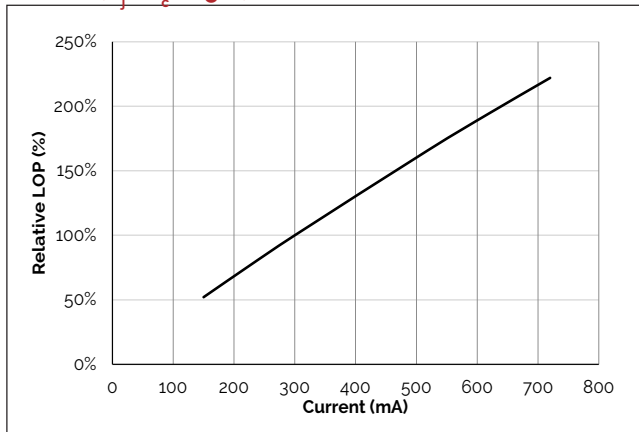

Figure 4: V8E Typical Relative Luminous Flux vs. Drive Current ($T_j = T_c = 25^\circ\text{C}$)¹

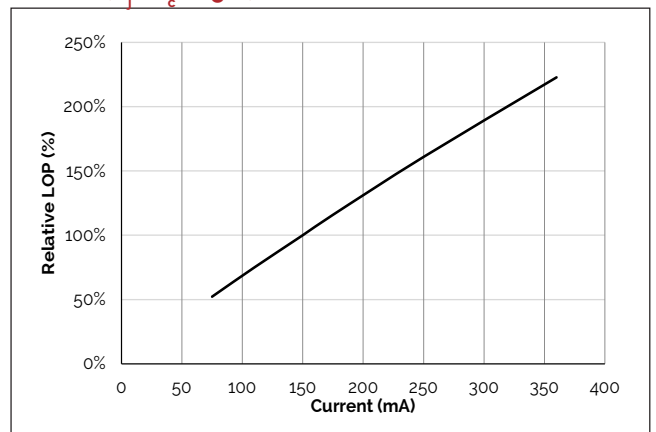

Figure 5: Typical DC Flux vs. Case Temperature

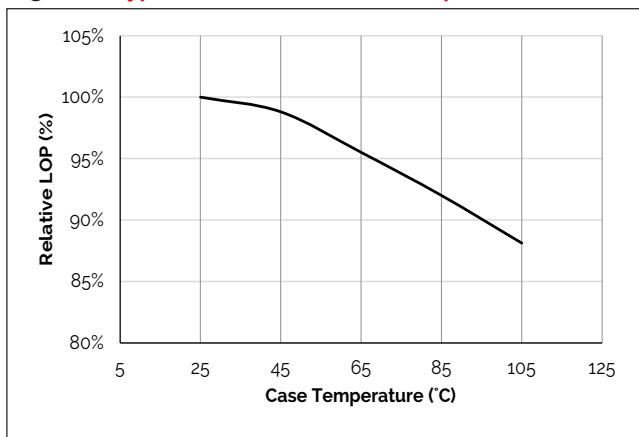
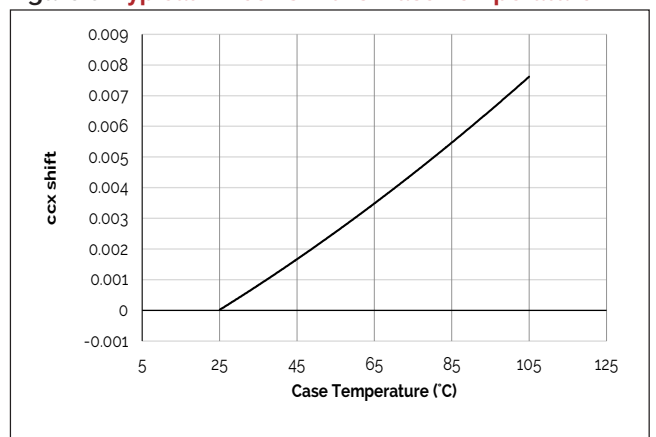

Figure 6: Typical DC ccx Shift vs. Case Temperature



Notes for Figures 1-4:

1. Bridgelux does not recommend driving high power LEDs at low currents. Doing so may produce unpredictable results. Pulse width modulation (PWM) is recommended for dimming effects.
2. Products tested under pulsed condition (10ms pulse width) at nominal test current where T_j (junction temperature) = T_c (case temperature) = 25°C .

Note for Figures 5-9:

1. Characteristics shown for Warm White.

Performance Curves

Figure 7: Typical DC ccy Shift vs. Case Temperature

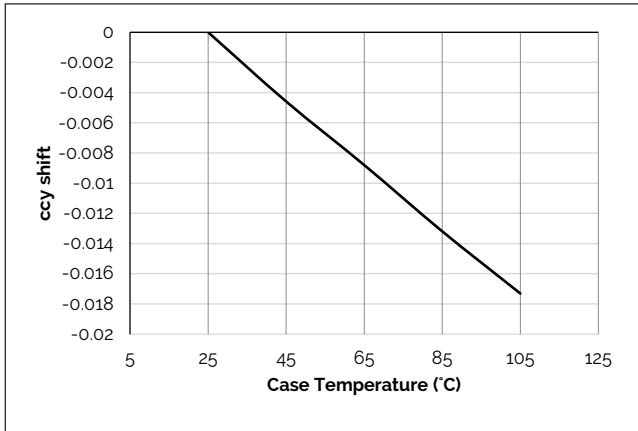

Figure 8: V8D Drive Current vs. ccx Shift

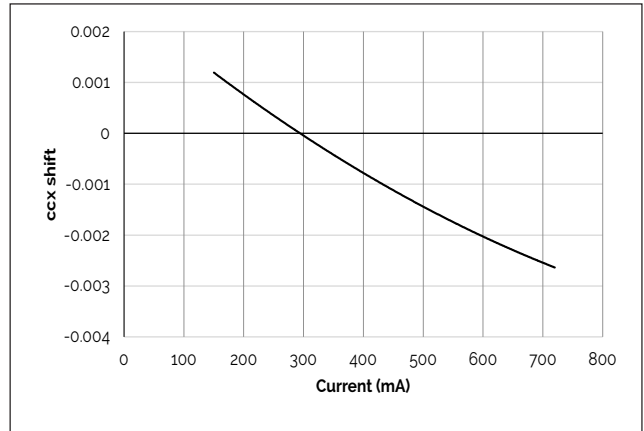

Figure 9: V8D Drive Current vs. ccy Shift

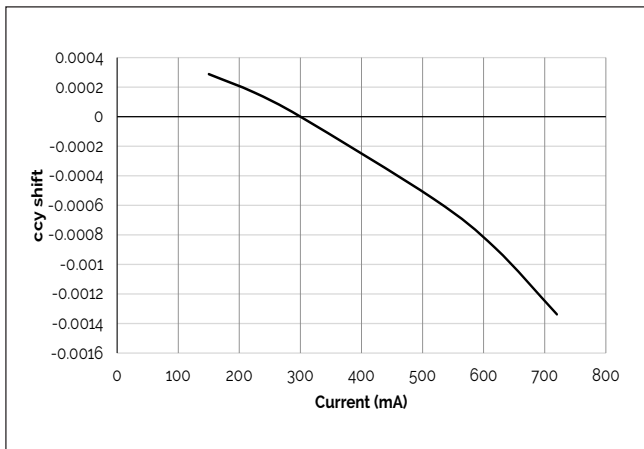

Figure 10: V8E Drive Current vs. ccx Shift

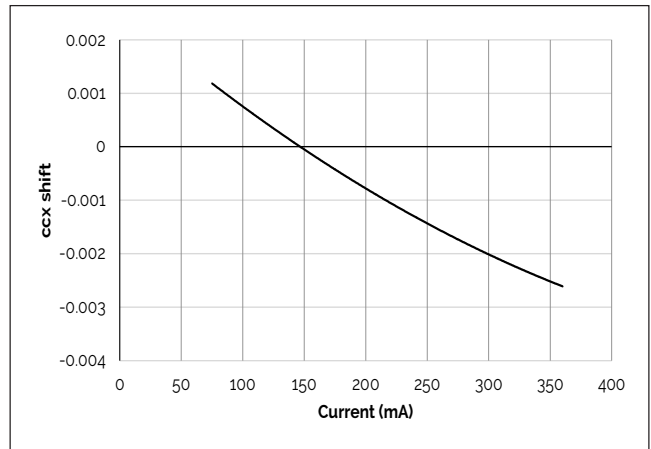

Figure 11: V8E Drive Current vs. ccy Shift

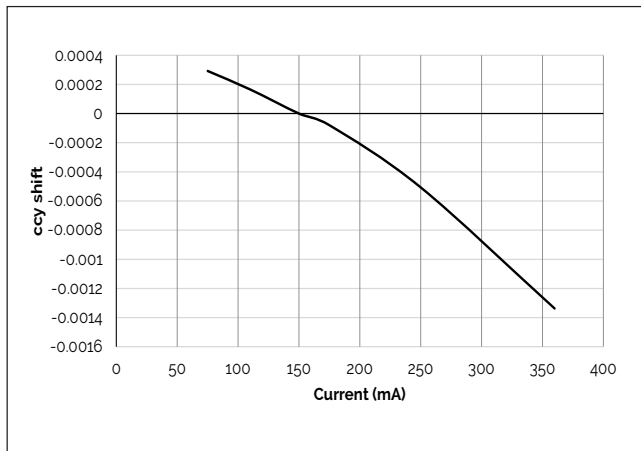
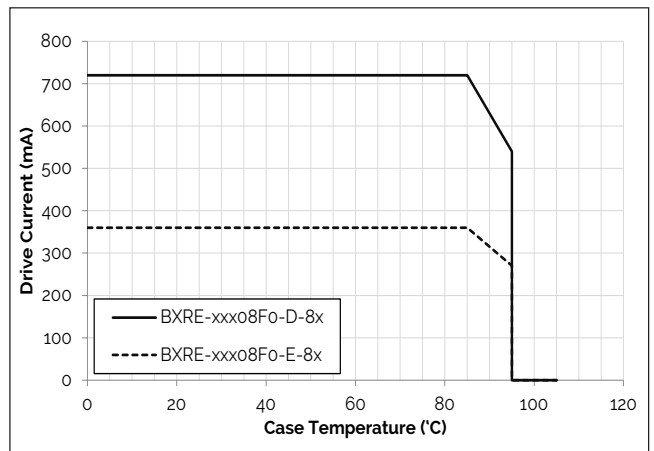

Figure 12: Derating Curve



Note for Figures 7-11:
1. Characteristics shown for Warm White.

Typical Radiation Pattern

Figure 13: Typical Spatial Radiation Pattern

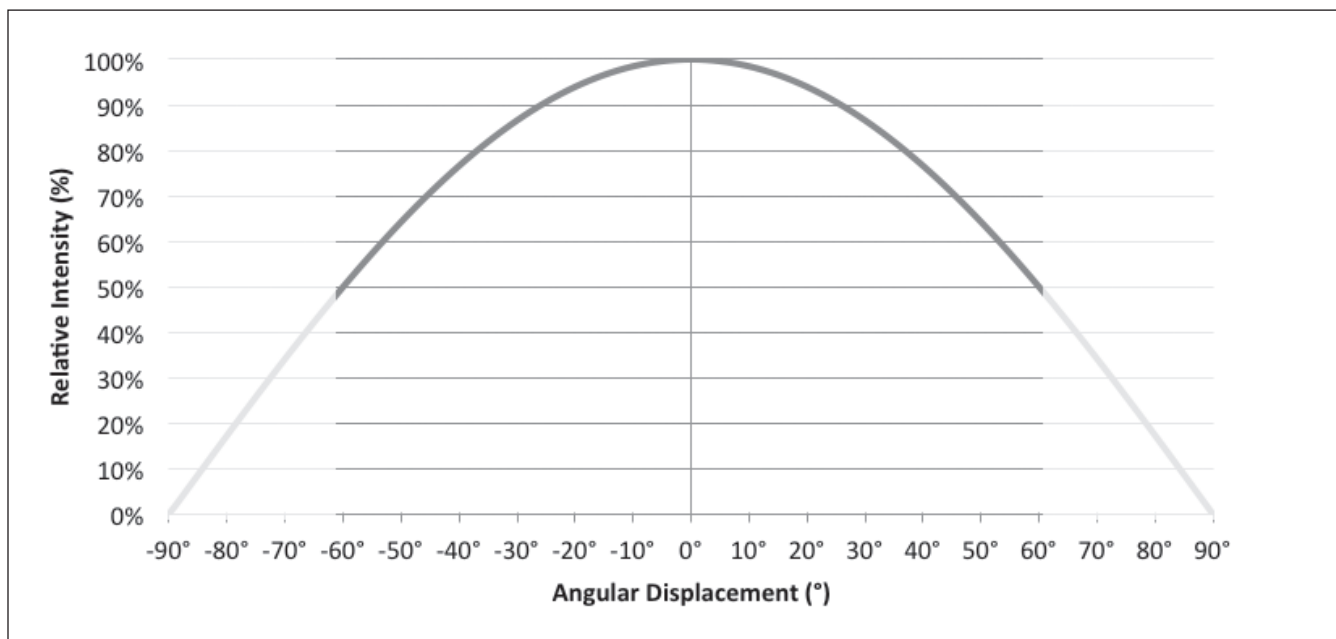

Notes for Figure 13:

1. Typical viewing angle is 120°.
2. The viewing angle is defined as the off axis angle from the centerline where intensity is ½ of the peak value.

Figure 14: Typical Polar Radiation Pattern

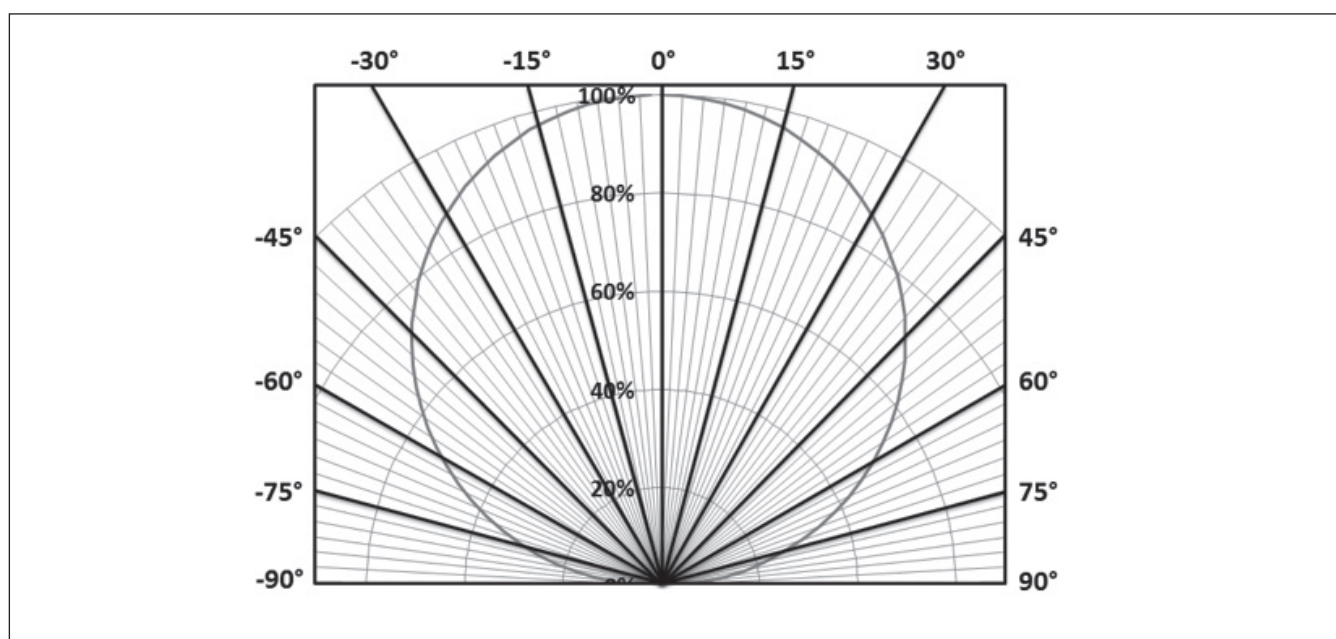

Typical Color spectrum

Figure 15: Typical Color Spectrum

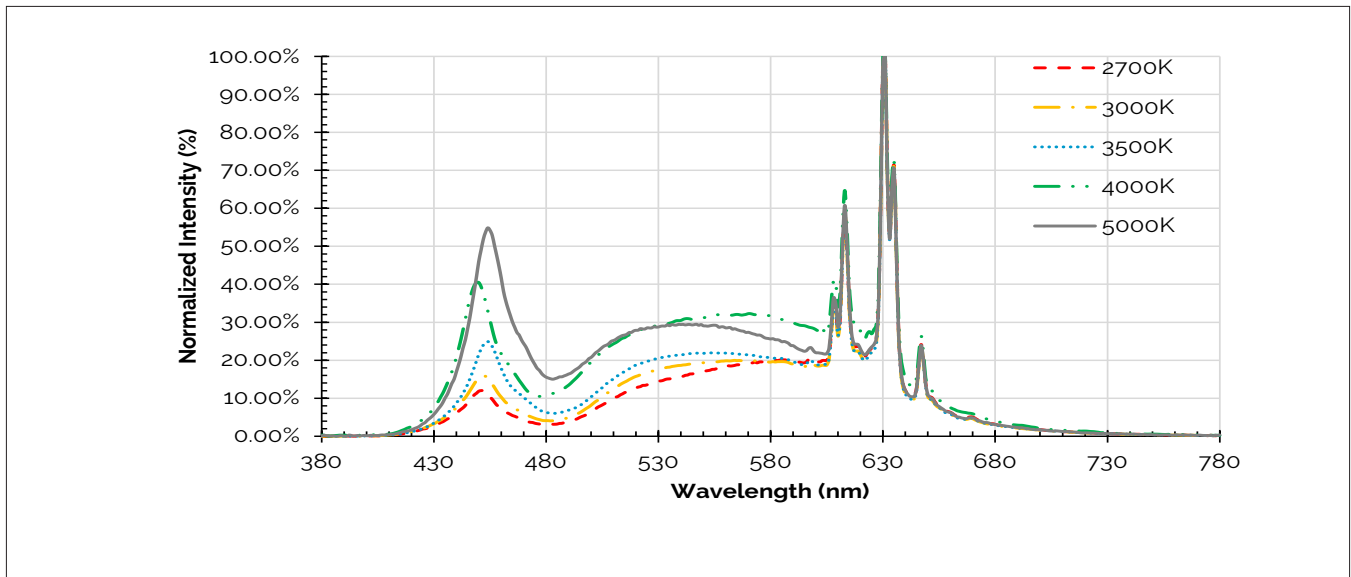

Notes for Figure 15:

1. Color spectra measured at nominal current for $T_j = T_c = 85^\circ\text{C}$.
2. Color spectra shown is 2700K and 90CRI.
3. Color spectra shown is 3000K and 90 CRI.
4. Color spectra shown is 3500K and 90 CRI.
5. Color spectra shown is 4000K and 90 CRI.
6. Color spectra shown is 5000K and 90 CRI.

Mechanical Dimensions

Figure 16: Drawing for V8 LED Array

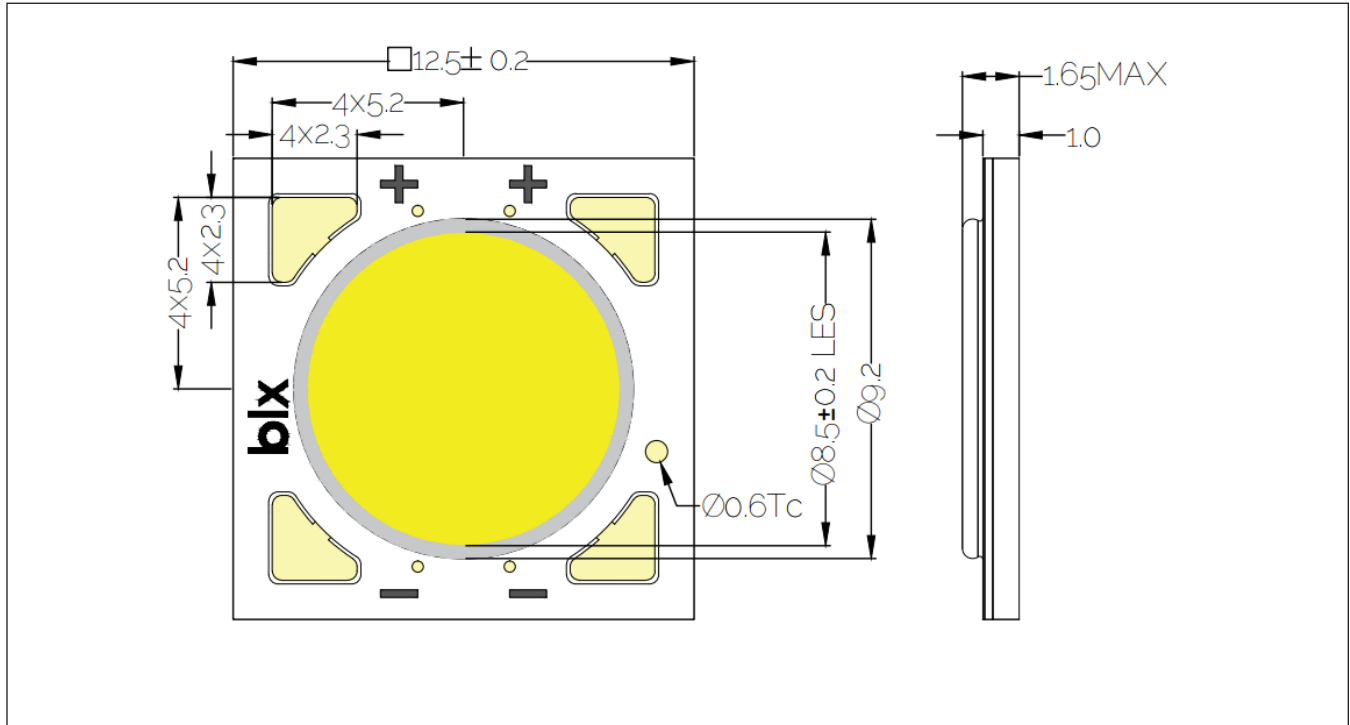

Notes for Figure 16:

1. Drawings are not to scale.
2. Drawing dimensions are in millimeters.
3. Unless otherwise specified, tolerances are ± 0.1 mm.
4. Solder pad labeled "+" denotes positive contact.
5. Refer to Application Notes AN101 for product handling, mounting and heat sink recommendations.
6. The optical center of the LED Array is nominally defined by the mechanical center of the array to a tolerance of ± 0.2 mm.
7. Bridgelux maintains a flatness of 0.10 mm across the mounting surface of the array.

Color Binning Information

Figure 17: Warm and Neutral White Test Bins in xy Color Space

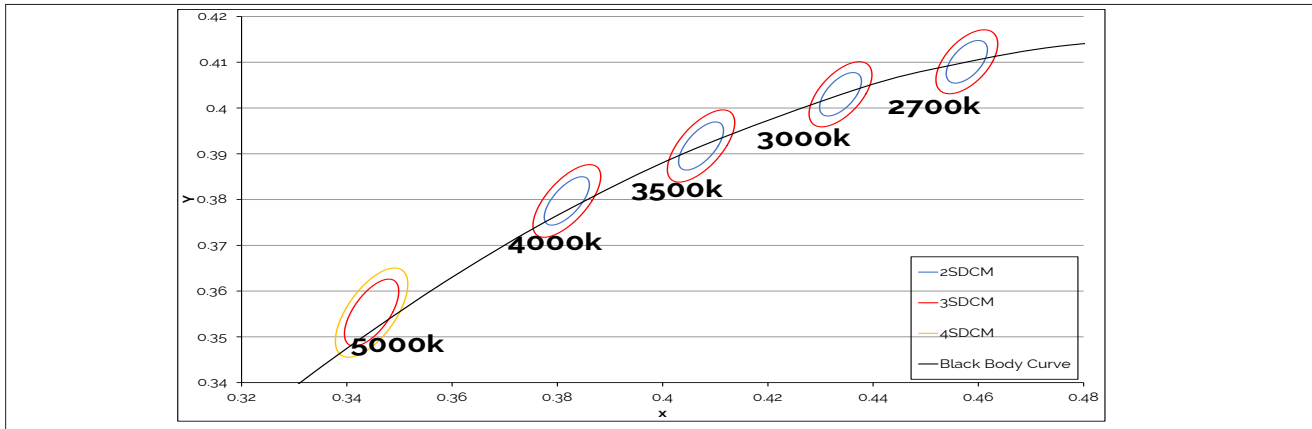

Note: Pulsed Test Conditions, $T_c = 85^\circ\text{C}$

Table 8: Warm and Neutral White xy Bin Coordinates and Associated Typical CCT (product is hot targeted to $T_c = 85^\circ\text{C}$)

Bin Code	2700K	3000K	3500K	4000K
ANSI Bin (for reference only)	(2580K - 2870K)	(2870K - 3220K)	(3220K - 3710K)	(3710K - 4260K)
83 (3 SDCM)	(2651K - 2794K)	(2968K - 3136K)	(3369K - 3586K)	(3851K - 4130K)
82 (2 SDCM)	(2674K - 2769K)	(2995K - 3107K)	(3404K - 3548K)	(3895K - 4081K)
Center Point (x,y)	(0.4578, 0.4101)	(0.4338, 0.403)	(0.4073, 0.3917)	(0.3818, 0.3797)

Table 9: Cool White xy Bin Coordinates and Associated Typical CCT (product is hot targeted to $T_c = 85^\circ\text{C}$)

Bin Code	5000K
ANSI Bin (for reference only)	(4745K - 5311K)
84 (4 SDCM)	(4801K - 5282K)
83 (3 SDCM)	(4835K - 5215K)
Center Point (x,y)	(0.3447, 0.3553)

Note for Tables 8-g:

1. Bridgelux maintains a tolerance of +/- 0.007 on x and y color coordinates in the CIE 1931 color Space.

Packaging and Labeling

Figure 18: Drawing for V8 Packaging Tube

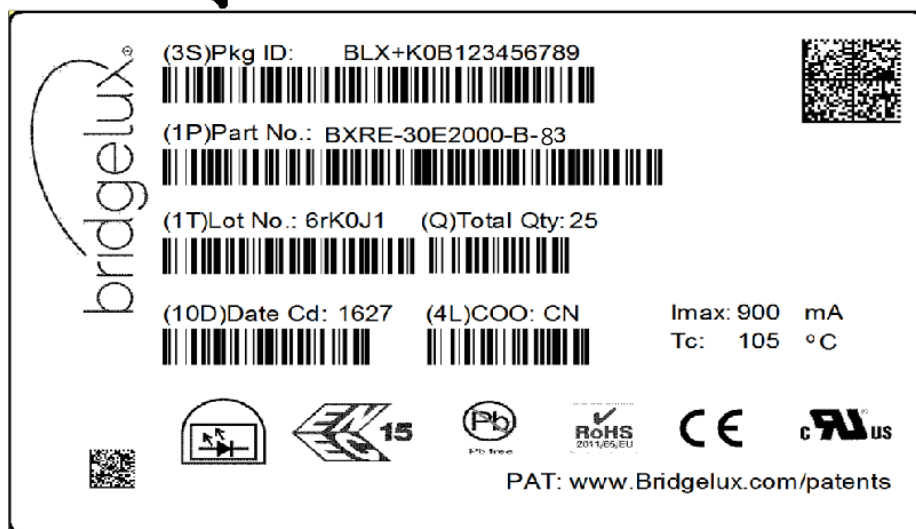

Box Label

Commercial Invoice
and Packing list



Notes for Figure 18:

1. Each tube holds 40 V8 COB arrays.
2. One tube is sealed in an anti-static bag. Four bags are placed in a shipping box. Depending on quantities ordered, a bigger shipping box, containing four boxes may be used to ship products.
3. Each bag and box is to be labeled as shown above.
4. Dimensions for each tube are 8.3mm (W) x 14.3mm (H) x 530mm (L). Dimensions for the anti-static bag are 75 (W) x 615 (L) x 31 (T) mm. Dimensions for the shipping box are 58.7 x 133 x 7.9 cm

Packaging and Labeling

Figure 19: Gen. 8 Product Labeling

Bridgelux COB arrays have laser markings on the back side of the substrate to help with product identification. In addition to the product identification markings, Bridgelux COB arrays also contain markings for internal Bridgelux manufacturing use only. The image below shows which markings are for customer use and which ones are for Bridgelux internal use only. The Bridgelux internal manufacturing markings are subject to change without notice, however these will not impact the form, function or performance of the COB array.



Design Resources

Application Notes

Bridgelux has developed a comprehensive set of application notes and design resources to assist customers in successfully designing with the V Series product family of LED array products. For all available application notes visit www.bridgelux.com.

Optical Source Models

Optical source models and ray set files are available for all Bridgelux products. Please contact your Bridgelux Sales Representative for more information.

3D CAD Models

Three dimensional CAD models depicting the product outline of all Bridgelux V Series LED arrays are available in both IGS and STEP formats. Please contact your Bridgelux sales representative for assistance.

LM80

LM80 testing has been completed and the LM80 report is now available. Please contact your Bridgelux sales representatives for LM-80 report.

Precautions

CAUTION: CHEMICAL EXPOSURE HAZARD

Exposure to some chemicals commonly used in luminaire manufacturing and assembly can cause damage to the LED array. Please consult Bridgelux Application Note AN101 for additional information.

CAUTION: RISK OF BURN

Do not touch the V Series LED array during operation. Allow the array to cool for a sufficient period of time before handling. The V Series LED array may reach elevated temperatures such that could burn skin when touched

CAUTION

CONTACT WITH LIGHT EMITTING SURFACE (LES)

Avoid any contact with the LES. Do not touch the LES of the LED array or apply stress to the LES (yellow phosphor resin area). Contact may cause damage to the LED array.

Optics and reflectors must not be mounted in contact with the LES (yellow phosphor resin area). Use the mechanical features of the LED array housing and/or edges to locate and secure optical devices as needed.

Disclaimers

MINOR PRODUCT CHANGE POLICY

The rigorous qualification testing on products offered by Bridgelux provides performance assurance. Slight cosmetic changes that do not affect form, fit, or function may occur as Bridgelux continues product optimization.

STANDARD TEST CONDITIONS

Unless otherwise stated, array testing is performed at the nominal drive current.

About Bridgelux: Bridging Light and Life™

At Bridgelux, we help companies, industries and people experience the power and possibility of light. Since 2002, we've designed LED solutions that are high performing, energy efficient, cost effective and easy to integrate. Our focus is on light's impact on human behavior, delivering products that create better environments, experiences and returns—both experiential and financial. And our patented technology drives new platforms for commercial and industrial luminaires.

For more information about the company, please visit
bridgelux.com
twitter.com/Bridgelux
facebook.com/Bridgelux
youtube.com/user/Bridgelux
linkedin.com/company/bridgelux-inc-_2
WeChat ID: BridgeluxInChina



46410 Fremont Boulevard
Fremont, CA 94538 USA
Tel (925) 583-8400
www.bridgelux.com

© 2022 Bridgelux, Inc. All rights reserved. Product specifications are subject to change without notice. Bridgelux, the Bridgelux stylized logo design and Vero are registered trademarks. V Series and Decor Series are trademarks of Bridgelux, Inc. All other trademarks are the property of their respective owners.

Bridgelux Gen8 V8 F90 Array Series Product Data Sheet DS445 Rev. B (11/2022)