

# Bridgelux® V13 Array

Product Data Sheet DS44



BXRE-27x2000

30x2000

35x2000

40x2000

50x2000

57x2000

65x2000

# Introduction

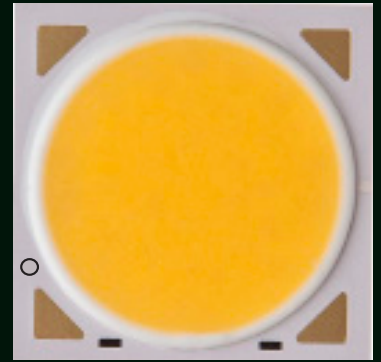

The V Series™ LED Array products deliver high quality light in a compact and cost-effective solid-state lighting package. These Chip-on-Board (CoB) arrays can be efficiently driven at twice the nominal drive current, enabling design flexibility not previously possible. This high flux density light source is designed to support a wide range of high quality, low cost directional luminaires and replacement lamps for commercial and residential applications.

The V13 LED Array is available in a variety of electrical, CCT and CRI combinations providing substantial design flexibility and energy efficiencies.

Lighting system designs incorporating these LED Arrays deliver increased system level efficacy and longer service life. Typical applications include, but are not limited to, replacement lamps, task, accent, spot, track, down light, wide area, security, and wall pack.

## Features

- Efficacy of 130 lm/W typical
- Compact high flux density light source
- Uniform high quality illumination
- Minimum 70, 80 and 90 CRI options
- Streamlined thermal path
- Energy Star / ANSI compliant color binning structure with 3SDCM and 4SDCM options
- More energy efficient than incandescent, halogen and fluorescent lamps
- Low voltage DC operation
- Instant light with unlimited dimming

## Benefits

- Enhanced optical control
- Clean white light without pixilation
- High quality true color reproduction
- Significantly reduced thermal resistance and increased operating temperatures
- Uniform consistent white light
- Lower operating costs
- Easy to use with daylight and motion detectors to enable increased energy savings
- Reduced maintenance costs
- Environmentally friendly, no disposal issue

# Contents

Product Feature Map	2
Product Nomenclature	2
Product Selection Guide	3
European Product Registry for Energy Labeling	4
Performance at Commonly Used Drive Currents	5
Electrical Characteristics	7
Absolute Maximum Ratings	8
Performance Curves	9
Typical Radiation Pattern	12
Typical Color Spectrum	13
Mechanical Dimensions	14
Color Binning Information	15
Packaging and Labeling	16
Design Resources	18
Precautions	18
Disclaimers	18
About Bridgelux	19

# Product Feature Map

Bridgelux arrays are fully engineered devices that provide consistent thermal and optical performance on an engineered mechanical platform. The V Series arrays are

the most compact chip-on-board devices across all of Bridgelux's LED Array products. The arrays incorporate several features to simplify design integration and assembly.

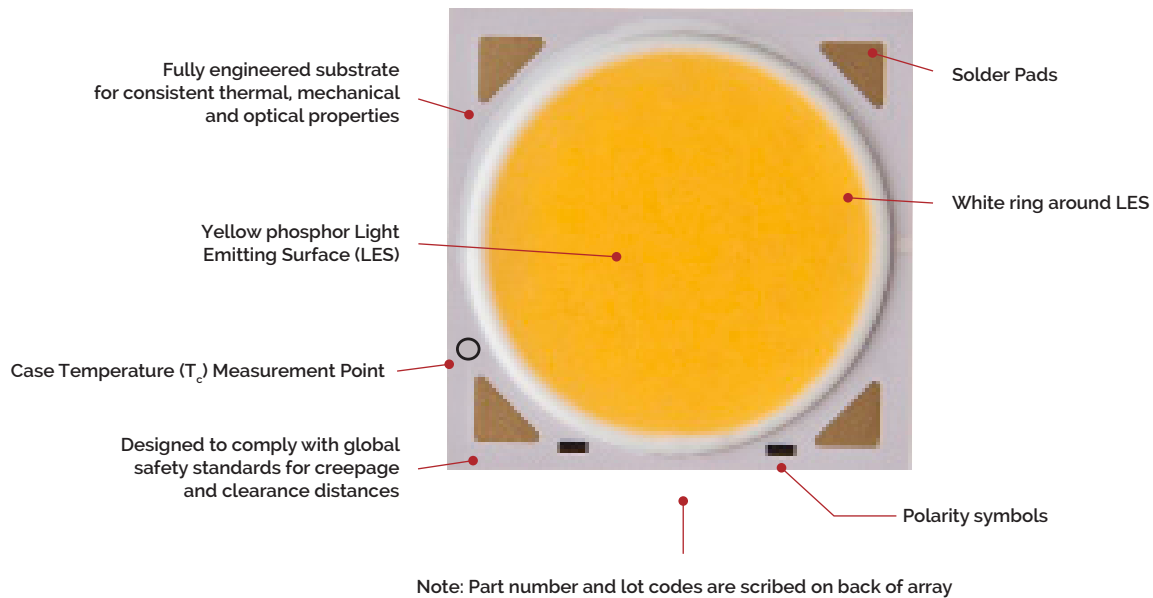

## Product Nomenclature

The part number designation for Bridgelux V Series LED arrays is explained as follows:

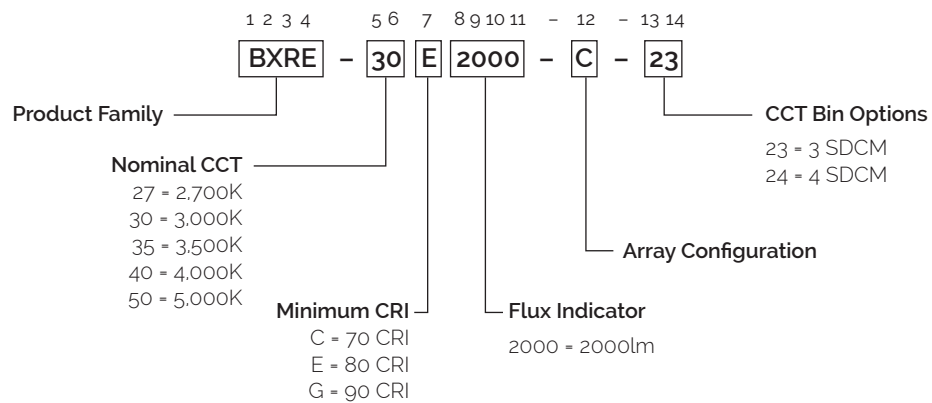

# Product Selection Guide

The following product configurations are available:

**Table 1:** Selection Guide, Pulsed Measurement Data ( $T_j = T_c = 25^\circ\text{C}$ )

Part Number	Nominal CCT <sup>1</sup> (K)	CRI <sup>2</sup>	Nominal Drive Current <sup>3</sup> (mA)	Typical Pulsed Flux <sup>4,5,6</sup> $T_c = 25^\circ\text{C}$ (lm)	Minimum Pulsed Flux <sup>6,7</sup> $T_c = 25^\circ\text{C}$ (lm)	Typical $V_f$ (V)	Typical Power (W)	Typical Efficacy (lm/W)
BXRE-27E2000-C-2X	2700	80	500	2039	1935	32.3	16.2	126
BXRE-27G2000-C-2X	2700	90	500	1696	1576	32.3	16.2	105
BXRE-30E2000-C-2X	3000	80	500	2133	1947	32.3	16.2	132
BXRE-30G2000-C-2X	3000	90	500	1785	1605	32.3	16.2	111
BXRE-35E2000-C-2X	3500	80	500	2187	2000	32.3	16.2	135
BXRE-35G2000-C-2X	3500	80	500	1868	1776	32.3	16.2	116
BXRE-40E2000-C-2X	4000	80	500	2262	2114	32.3	16.2	140
BXRE-40G2000-C-2X	4000	90	500	1928	1786	32.3	16.2	119
BXRE-50C2000-C-2X	5000	70	500	2394	2245	32.3	16.2	148
BXRE-50E2000-C-2X	5000	80	500	2252	2114	32.3	16.2	139
BXRE-50G2000-C-2X	5000	90	500	2015	1809	32.3	16.2	125

**Table 2:** Selection Guide, Stabilized DC Performance ( $T_c = 85^\circ\text{C}$ )<sup>8,9</sup>

Part Number	Nominal CCT <sup>1</sup> (K)	CRI <sup>2</sup>	Nominal Drive Current <sup>3</sup> (mA)	Typical DC Flux $T_c = 85^\circ\text{C}$ (lm)	Minimum DC Flux <sup>10</sup> $T_c = 85^\circ\text{C}$ (lm)	Typical $V_f$ (V)	Typical Power (W)	Typical Efficacy (lm/W)
BXRE-27E2000-C-2X	2700	80	500	1867	1772	31.3	15.6	119
BXRE-27G2000-C-2X	2700	90	500	1492	1387	31.3	15.6	95
BXRE-30E2000-C-2X	3000	80	500	1921	1754	31.3	15.6	123
BXRE-30G2000-C-2X	3000	90	500	1571	1412	31.3	15.6	100
BXRE-35E2000-C-2X	3500	80	500	1981	1811	31.3	15.6	127
BXRE-35G2000-C-2X	3500	80	500	1644	1563	31.3	15.6	105
BXRE-40E2000-C-2X	4000	80	500	2040	1907	31.3	15.6	130
BXRE-40G2000-C-2X	4000	90	500	1697	1572	31.3	15.6	108
BXRE-50C2000-C-2X	5000	70	500	2107	1976	31.3	15.6	135
BXRE-50E2000-C-2X	5000	80	500	1982	1860	31.3	15.6	127
BXRE-50G2000-C-2X	5000	90	500	1773	1592	31.3	15.6	113

Notes for Tables 1 & 2:

- Nominal CCT as defined by ANSI C78.377-2011.
- CRI Values are minimums. Minimum Rg value for 80 CRI products is 0, the minimum Rg values for 90 CRI products is 50.
- Drive current is referred to as nominal drive current.
- Products tested under pulsed condition (10ms pulse width) at nominal test current where  $T_j$  (junction temperature) -  $T_c$  (case temperature) -  $25^\circ\text{C}$ .
- Typical performance values are provided as a reference only and are not a guarantee of performance.
- Bridgelux maintains a  $\pm 7\%$  tolerance on flux measurements.
- Minimum flux values at nominal test current are guaranteed by 100% test.
- Typical stabilized DC performance values are provided as reference only and are not a guarantee of performance.
- Typical performance is estimated based on operation under DC (direct current) with LED array mounted onto a heat sink with thermal interface material and the case temperature maintained at  $85^\circ\text{C}$ . Based on Bridgelux test setup, values may vary depending on the thermal design of the luminaire and/or the exposed environment to which the product is subjected.
- Minimum flux values at elevated temperatures are provided for reference only and are not guaranteed by 100% production testing. Based on Bridgelux test setup, values may vary depending on the thermal design of the luminaire and/or the exposed environment to which the product is subjected.

# European Product Registry for Energy Labeling

The European Product Registry for Energy Labeling (EPREL) is defined in the EU Regulation 2017/1369 to provide important energy efficiency information to consumers. Together with Energy Labeling Regulation ELR (EU) 2019/2015 which was amended by regulation (EU) 2021/340 for energy labelling of light sources, manufacturers are required to declare an energy class based on key technical specifications from each of their product and register it in an open data base managed by EPREL. It is now a legal requirement for a vendor of light sources to upload information about their products into the EPREL database before placing these products on the market in the EU.

Table 3 below provides a list of part numbers that are in compliance with ELR and are currently listed in the EPREL database.

At Bridgelux, we are fully committed to supplying products that are compliant with pertinent laws, rules, and obligation imposed by relevant government bodies including the European Energy Labeling regulation. Customers can use these products with full confidence for any projects that fall under the ELR.

**Table 3:** Part numbers registered in European Product Registry for Energy Labeling

PART NUMBER <sup>1</sup>	CCT (K)	CRI	Current <sup>2</sup> (mA)	Vf (V)	Useful flux <sup>3</sup> ( $\Phi_{use}$ ) at 85°C (lm)	Power (W)	Efficacy (lm/W)	Energy efficiency class <sup>4</sup> 	Registration No	URL to Product Information Sheet in EPREL Database
BXRE-27E2000-C-2x	2700	80	550	31.6	1920	17.4	110	F	869120	<a href="https://eprelec.europa.eu/qr/869120">https://eprelec.europa.eu/qr/869120</a>
BXRE-27G2000-C-2x	2700	90	310	30.3	895	9.4	95	F	869248	<a href="https://eprelec.europa.eu/qr/869248">https://eprelec.europa.eu/qr/869248</a>
BXRE-30E2000-C-2x	3000	80	610	31.9	2173	19.5	112	F	869551	<a href="https://eprelec.europa.eu/qr/869551">https://eprelec.europa.eu/qr/869551</a>
BXRE-30G2000-C-2x	3000	90	370	30.7	1114	11.3	98	F	869678	<a href="https://eprelec.europa.eu/qr/869678">https://eprelec.europa.eu/qr/869678</a>
BXRE-35E2000-C-2x	3500	80	680	32.3	2472	21.9	113	F	869922	<a href="https://eprelec.europa.eu/qr/869922">https://eprelec.europa.eu/qr/869922</a>
BXRE-35G2000-C-2x	3500	90	430	31.0	1343	13.3	101	F	870014	<a href="https://eprelec.europa.eu/qr/870014">https://eprelec.europa.eu/qr/870014</a>
BXRE-40E2000-C-2x	4000	80	760	32.7	2812	24.8	113	F	870229	<a href="https://eprelec.europa.eu/qr/870229">https://eprelec.europa.eu/qr/870229</a>
BXRE-40G2000-C-2x	4000	90	490	31.3	1567	15.3	102	F	870333	<a href="https://eprelec.europa.eu/qr/870333">https://eprelec.europa.eu/qr/870333</a>
BXRE-50C2000-C-2x	5000	70	670	32.2	2595	21.6	120	E	870452	<a href="https://eprelec.europa.eu/qr/870452">https://eprelec.europa.eu/qr/870452</a>
BXRE-50E2000-C-2x	5000	80	690	32.3	2506	22.3	112	F	870523	<a href="https://eprelec.europa.eu/qr/870523">https://eprelec.europa.eu/qr/870523</a>
BXRE-50G2000-C-2x	5000	90	580	31.8	1915	18.4	104	F	870593	<a href="https://eprelec.europa.eu/qr/870593">https://eprelec.europa.eu/qr/870593</a>

Notes for Table 3:

1. All device listed here must be disposed as e-waste upon its end of life according to local country guideline in each country.
2. For information on performance values at alternative drive conditions, please refer to the Product Selection Guide, Absolute Maximum Rating Table and Performance Curves in this data sheet.
3. For a definition of useful luminous flux ( $\Phi_{use}$ ), please see the ELR regulations at <https://tinyurl.com/4b6zvt4m>.
4. EPREL requires an arrow symbol containing the letter of the energy efficiency class to be displayed, on technical promotional material. Refer to this energy efficiency class column for specific energy efficiency class on each part number.

# Performance at Commonly Used Drive Currents

V Series LED arrays are tested to the specifications shown using the nominal drive currents in Table 1. V Series may also be driven at other drive currents dependent on specific application design requirements. The performance at any drive current can be derived from the current vs. voltage characteristics shown in Figure and the flux vs. current characteristics shown in Figure 2. The performance at commonly used drive currents is summarized in Table 4.

**Table 4:** Product Performance at Commonly Used Drive Currents

Part Number	CRI	Drive Current <sup>1</sup> (mA)	Typical $V_f$ $T_c = 25^\circ\text{C}$ (V)	Typical Power $T_c = 25^\circ\text{C}$ (W)	Typical Flux <sup>2</sup> $T_c = 25^\circ\text{C}$ (lm)	Typical DC Flux <sup>3</sup> $T_c = 85^\circ\text{C}$ (lm)	Typical Efficacy $T_c = 25^\circ\text{C}$ (lm/W)
BXRE-27E2000-C-2x	80	175	30.2	5.3	781	715	148
		350	31.4	11.0	1488	1361	135
		<b>500</b>	<b>32.3</b>	<b>16.2</b>	<b>2039</b>	<b>1867</b>	<b>126</b>
		700	33.4	23.4	2705	2484	116
		1050	35.1	36.9	3663	3382	99
BXRE-27G2000-C-2x	90	175	30.2	5.3	650	572	123
		350	31.4	11.0	1237	1088	113
		<b>500</b>	<b>32.3</b>	<b>16.2</b>	<b>1696</b>	<b>1492</b>	<b>105</b>
		700	33.4	23.4	2250	1985	96
		1050	35.1	36.9	3047	2703	83
BXRE-30E2000-C-2x	80	175	30.2	5.3	817	736	155
		350	31.4	11.0	1556	1400	142
		<b>500</b>	<b>32.3</b>	<b>16.2</b>	<b>2133</b>	<b>1921</b>	<b>132</b>
		700	33.4	23.4	2830	2556	121
		1050	35.1	36.9	3832	3480	104
BXRE-30G2000-C-2x	90	175	30.2	5.3	684	602	129
		350	31.4	11.0	1302	1145	119
		<b>500</b>	<b>32.3</b>	<b>16.2</b>	<b>1785</b>	<b>1571</b>	<b>111</b>
		700	33.4	23.4	2368	2090	101
		1050	35.1	36.9	3207	2845	87
BXRE-35E2000-C-2x	80	175	30.2	5.3	838	759	159
		350	31.4	11.0	1596	1444	145
		<b>500</b>	<b>32.3</b>	<b>16.2</b>	<b>2187</b>	<b>1981</b>	<b>135</b>
		700	33.4	23.4	2902	2635	124
		1050	35.1	36.9	3929	3587	107
BXRE-35G2000-C-2x	90	175	30.2	5.3	716	630	135
		350	31.4	11.0	1363	1198	124
		<b>500</b>	<b>32.3</b>	<b>16.2</b>	<b>1868</b>	<b>1644</b>	<b>116</b>
		700	33.4	23.4	2479	2187	106
		1050	35.1	36.9	3356	2977	91

Notes for Table 4:

1. Alternate drive currents in Table 4 are provided for reference only and are not a guarantee of performance.
2. Bridgelux maintains a  $\pm 7\%$  tolerance on flux measurements.
3. Typical stabilized DC performance values are provided as reference only and are not a guarantee of performance.

# Performance at Commonly Used Drive Currents

**Table 4:** Product Performance at Commonly Used Drive Currents (Continued)

Part Number	CRI	Drive Current <sup>1</sup> (mA)	Typical $V_f$ $T_c = 25^\circ\text{C}$ (V)	Typical Power $T_c = 25^\circ\text{C}$ (W)	Typical Flux <sup>2</sup> $T_c = 25^\circ\text{C}$ (lm)	Typical DC Flux <sup>3</sup> $T_c = 85^\circ\text{C}$ (lm)	Typical Efficacy $T_c = 25^\circ\text{C}$ (lm/W)
BXRE-40E2000-C-2x	80	175	30.2	5.3	867	781	164
		350	31.4	11.0	1650	1487	150
		<b>500</b>	<b>32.3</b>	<b>16.2</b>	<b>2262</b>	<b>2040</b>	<b>140</b>
		700	33.4	23.4	3001	2714	128
		1050	35.1	36.9	4064	3695	110
BXRE-40G2000-C-2x	90	175	30.2	5.3	739	650	140
		350	31.4	11.0	1407	1237	128
		<b>500</b>	<b>32.3</b>	<b>16.2</b>	<b>1928</b>	<b>1697</b>	<b>119</b>
		700	33.4	23.4	2558	2257	109
		1050	35.1	36.9	3464	3073	94
BXRE-50C2000-C-24	70	175	30.2	5.3	917	807	174
		350	31.4	11.0	1747	1536	159
		<b>500</b>	<b>32.3</b>	<b>16.2</b>	<b>2394</b>	<b>2107</b>	<b>148</b>
		700	33.4	23.4	3176	2803	136
		1050	35.1	36.9	4301	3816	117
BXRE-50E2000-C-24	80	175	30.2	5.3	863	759	163
		350	31.4	11.0	1643	1444	150
		<b>500</b>	<b>32.3</b>	<b>16.2</b>	<b>2252</b>	<b>1982</b>	<b>139</b>
		700	33.4	23.4	2988	2636	128
		1050	35.1	36.9	4046	3589	110
BXRE-50G2000-C-24	90	175	30.2	5.3	772	679	146
		350	31.4	11.0	1470	1292	134
		<b>500</b>	<b>32.3</b>	<b>16.2</b>	<b>2015</b>	<b>1773</b>	<b>125</b>
		700	33.4	23.4	2674	2359	114
		1050	35.1	36.9	3620	3212	98

Notes for Table 4:

1. Alternate drive currents in Table 4 are provided for reference only and are not a guarantee of performance.
2. Bridgelux maintains a  $\pm 7\%$  tolerance on flux measurements.
3. Typical stabilized DC performance values are provided as reference only and are not a guarantee of performance.



# Electrical Characteristics

**Table 5:** Electrical Characteristics

Part Number	Drive Current (mA)	Forward Voltage Pulsed, $T_c = 25^\circ\text{C}$ (V) <sup>1, 2, 3</sup>			Typical Coefficient of Forward Voltage <sup>4</sup> $\Delta V_f / \Delta T_c$ (mV/ $^\circ\text{C}$ )	Typical Thermal Resistance Junction to Case <sup>5, 6</sup> $R_{j-c}$ ( $^\circ\text{C}/\text{W}$ )	Driver Selection Voltages <sup>7</sup> (V)	
		Minimum	Typical	Maximum			$V_f$ Min. Hot $T_c = 105^\circ\text{C}$ (V)	$V_f$ Max. Cold $T_c = -40^\circ\text{C}$ (V)
BXRE-xxx2000-C-2x	500	29.9	32.3	34.7	-17	0.22	28.5	35.8
	1050	32.0	35.1	37.9	-17	0.28	30.6	39.0

Notes for Table 5:

- Parts are tested in pulsed conditions,  $T_c = 25^\circ\text{C}$ . Pulse width is 10ms.
- Voltage minimum and maximum are provided for reference only and are not a guarantee of performance.
- Bridgelux maintains a tester tolerance of  $\pm 0.10\text{V}$  on forward voltage measurements.
- Typical coefficient of forward voltage tolerance is  $\pm 0.1\text{mV}$  for nominal current.
- Thermal resistance values are based from test data of a 3000K 80 CRI product.
- Thermal resistance value was calculated using total electrical input power; optical power was not subtracted from input power. The thermal interface material used during testing is not included in the thermal resistance value.
- $V_f$  min hot and max cold values are provided as reference only and are not guaranteed by test. These values are provided to aid in driver design and selection over the operating range of the product.

# Absolute Maximum Ratings

**Table 6:** Maximum Ratings

Parameter	Maximum Rating
LED Junction Temperature ( $T_j$ )	150°C
Storage Temperature	-40°C to +105°C
Operating Case Temperature <sup>1</sup> ( $T_c$ )	105°C
Soldering Temperature <sup>2</sup>	350°C or lower for a maximum of 10 seconds
Maximum Drive Current <sup>3,4,5</sup>	1050mA
Maximum Peak Pulsed Drive Current <sup>6</sup>	1500mA
Maximum Reverse Voltage <sup>7</sup>	-55V

Notes for Table 6:

1. For IEC 62717 requirement, please consult your Bridgelux sales representative.
2. Refer to Bridgelux Application Note AN41: Assembly Considerations for Bridgelux V Series LED Arrays.
3. DC Forward Current for LM-80 is the maximum drive current for which LM-80 data is currently available.
4. Lumen maintenance (L70) and lifetime predictions are valid for drive current and case temperature conditions used for LM-80 testing as included in the applicable LM-80 test report for these arrays. Contact your Bridgelux sales representatives for LM-80 report.
5. Arrays may be driven at higher currents however lumen maintenance may be reduced.
6. Bridgelux recommends a maximum duty cycle of 10% and pulse width of 20 ms when operating LED Arrays at maximum peak pulsed current specified. Maximum peak pulsed currents indicate values where LED Arrays can be driven without catastrophic failures.
7. Light emitting diodes are not designed to be driven in reverse voltage and will not produce light under this condition. Maximum rating provided for reference only.

# Performance Curves

Figure 1: Drive Current vs. Voltage ( $T_j = T_c = 25^\circ\text{C}$ )

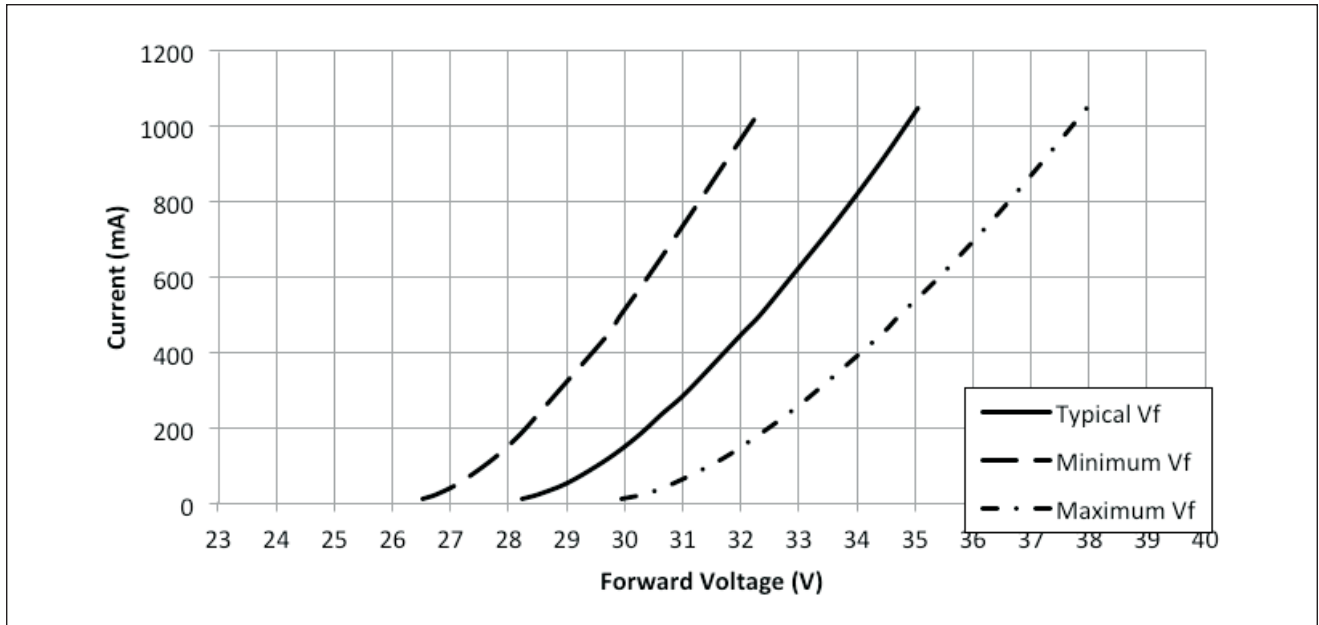
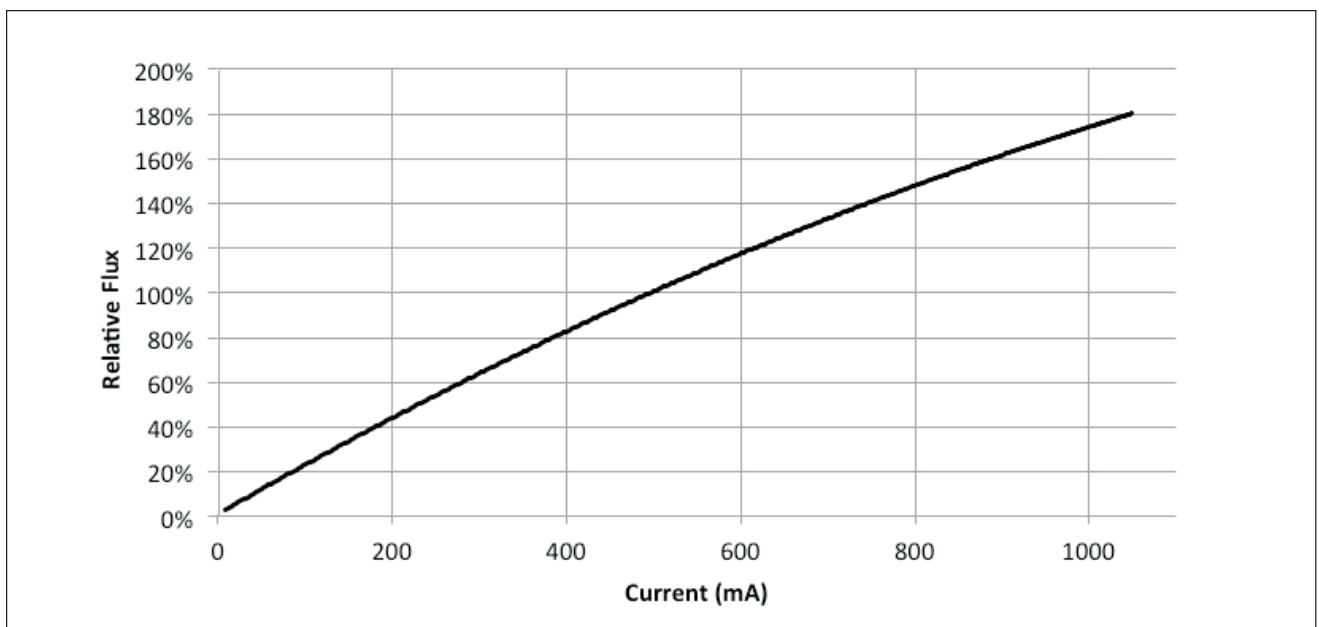

Figure 2: Typical Relative Luminous Flux vs. Current ( $T_j = T_c = 25^\circ\text{C}$ )



Note for Figure 2:

1. Bridgelux does not recommend driving high power LEDs at low currents. Doing so may produce unpredictable results. Pulse width modulation (PWM) is recommended for dimming effects.

# Performance Curves

**Figure 3: Typical DC Flux vs. Case Temperature**

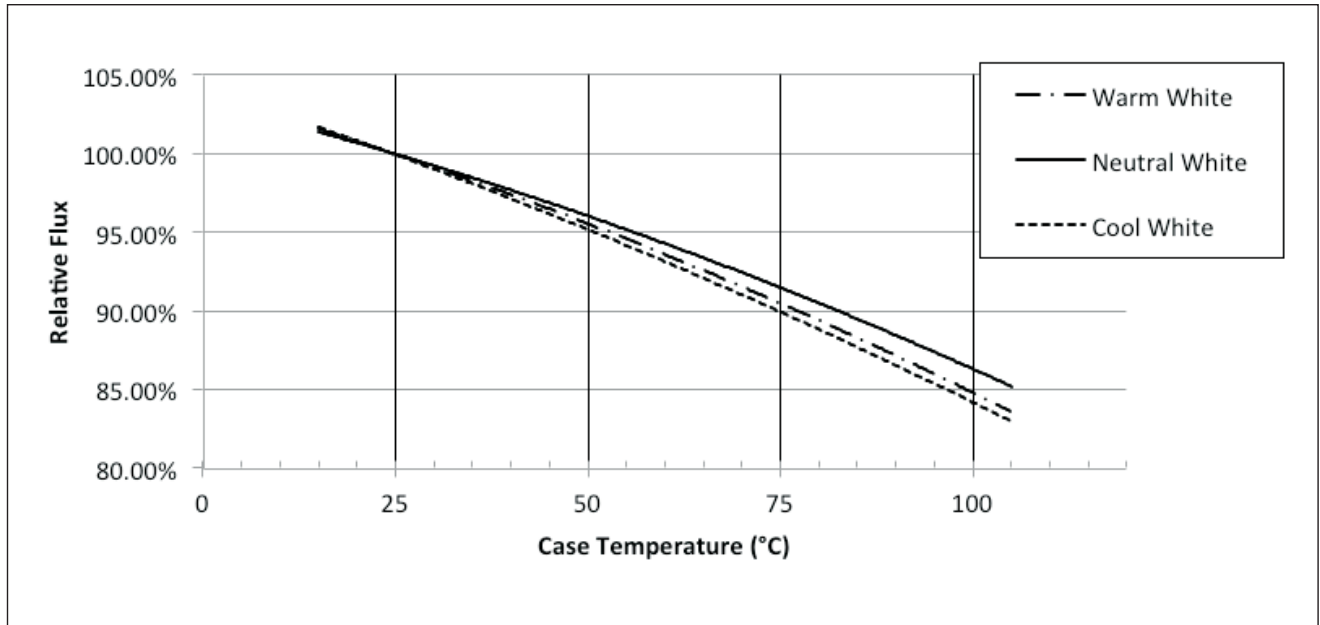

**Figure 4: Typical DC ccy Shift vs. Case Temperature**

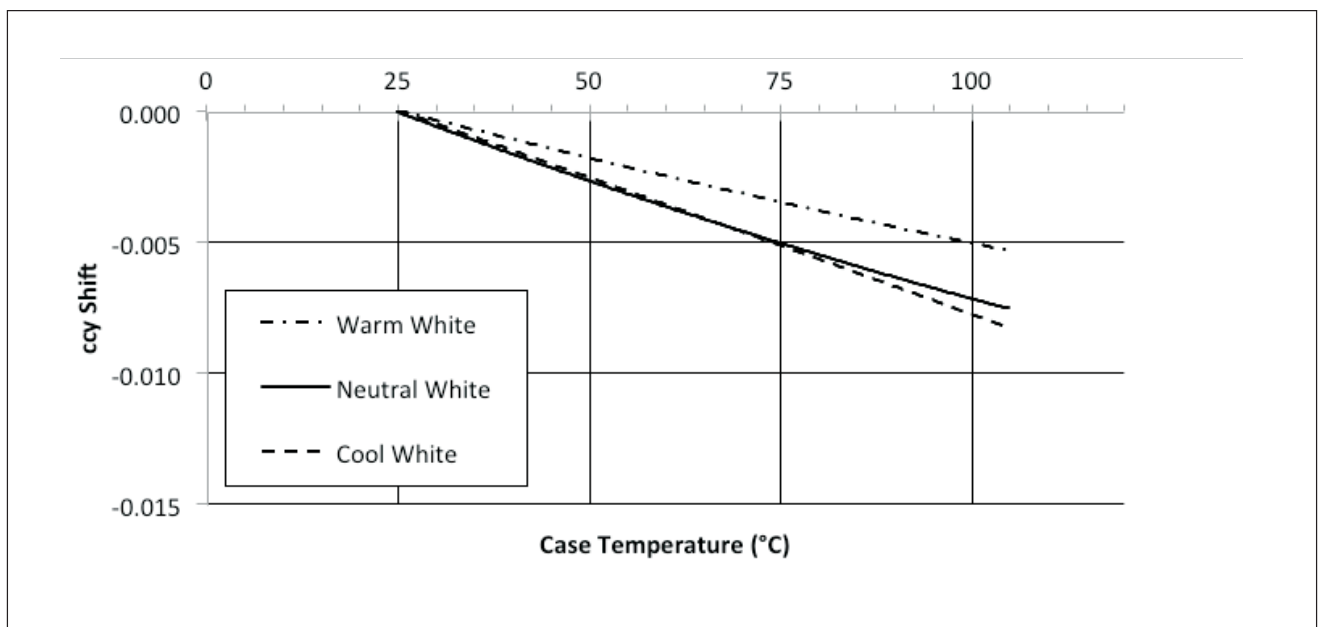

Notes for Figures 3-4:

1. Characteristics shown for warm white based on 3000K and 80 CRI.
2. Characteristics shown for neutral white based on 4000K and 80 CRI.
3. Characteristics shown for cool white based on 5000K and 70 CRI.
4. For other color SKUs, the shift in color will vary. Please contact your Bridgelux Sales Representative for more information.

# Performance Curves

Figure 5: Typical DC ccx Shift vs. Case Temperature

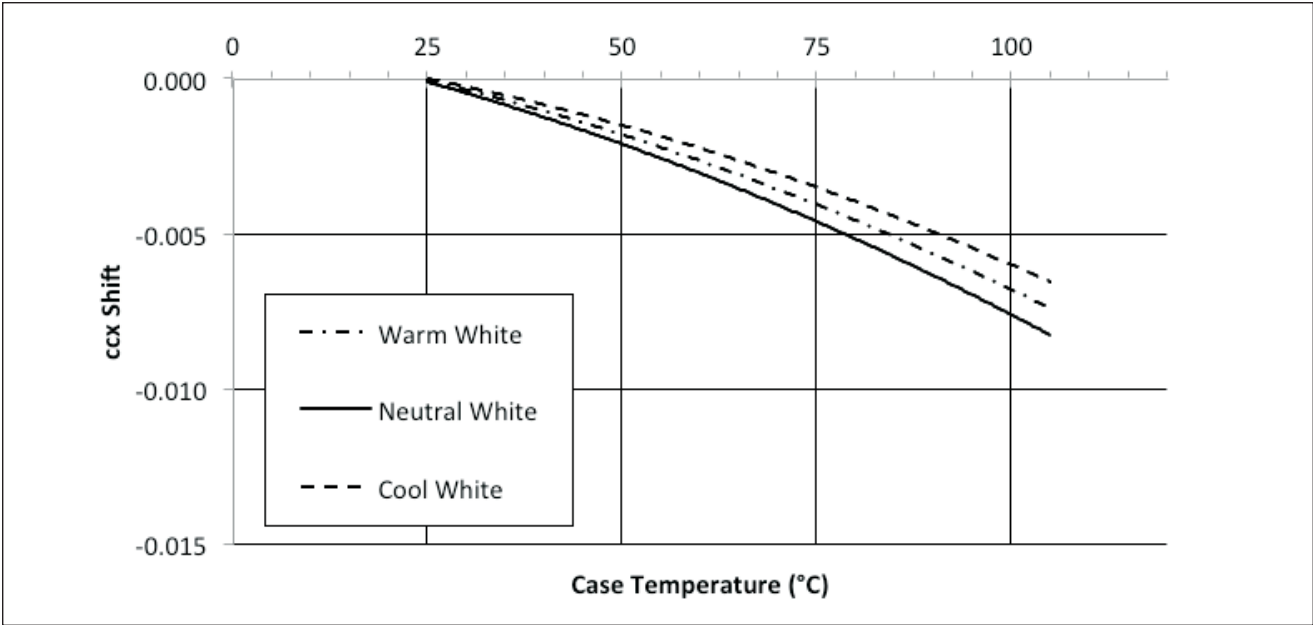

Notes for Figure 5:

- 1. Characteristics shown for warm white based on 3000K and 80 CRI.
- 2. Characteristics shown for neutral white based on 4000K and 80 CRI.
- 3. Characteristics shown for cool white based on 5000K and 70 CRI.
- 4. For other color SKUs, the shift in color will vary. Please contact your Bridgelux Sales Representative for more information.

# Typical Radiation Pattern

Figure 6: Typical Spatial Radiation Pattern

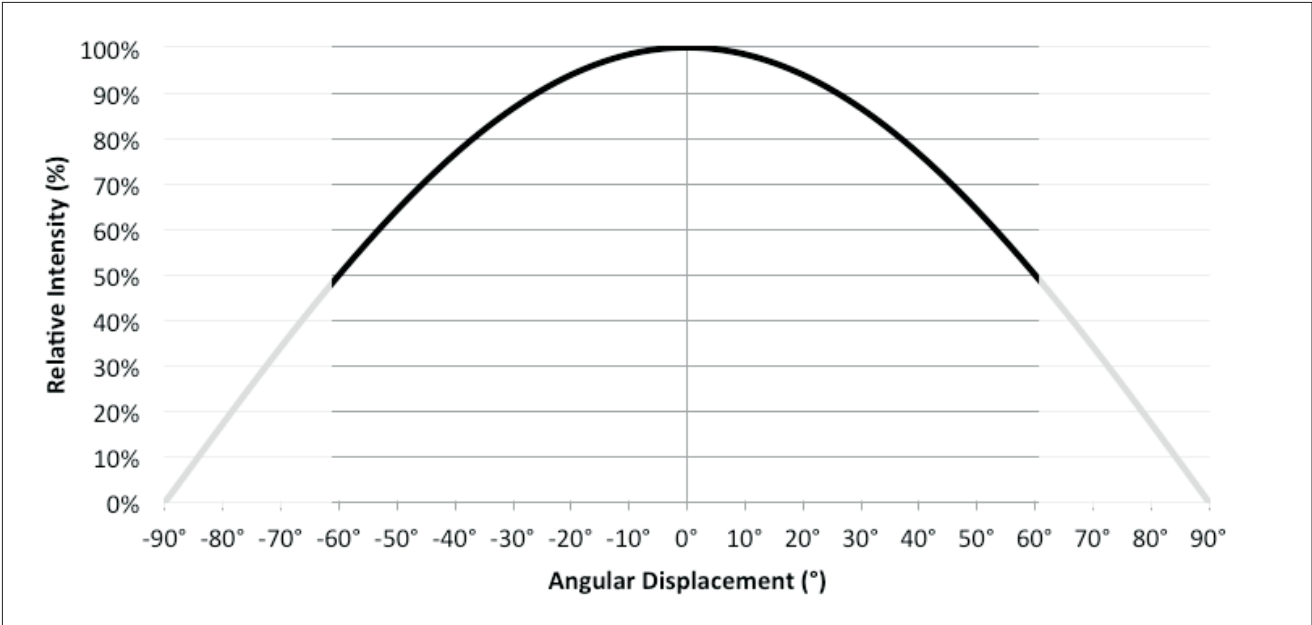

Note for Figure 6:

- 1. Typical viewing angle is 120°.
- 2. The viewing angle is defined as the off axis angle from the centerline where  $I_v$  is  $\frac{1}{2}$  of the peak value.

Figure 7: Typical Polar Radiation Pattern

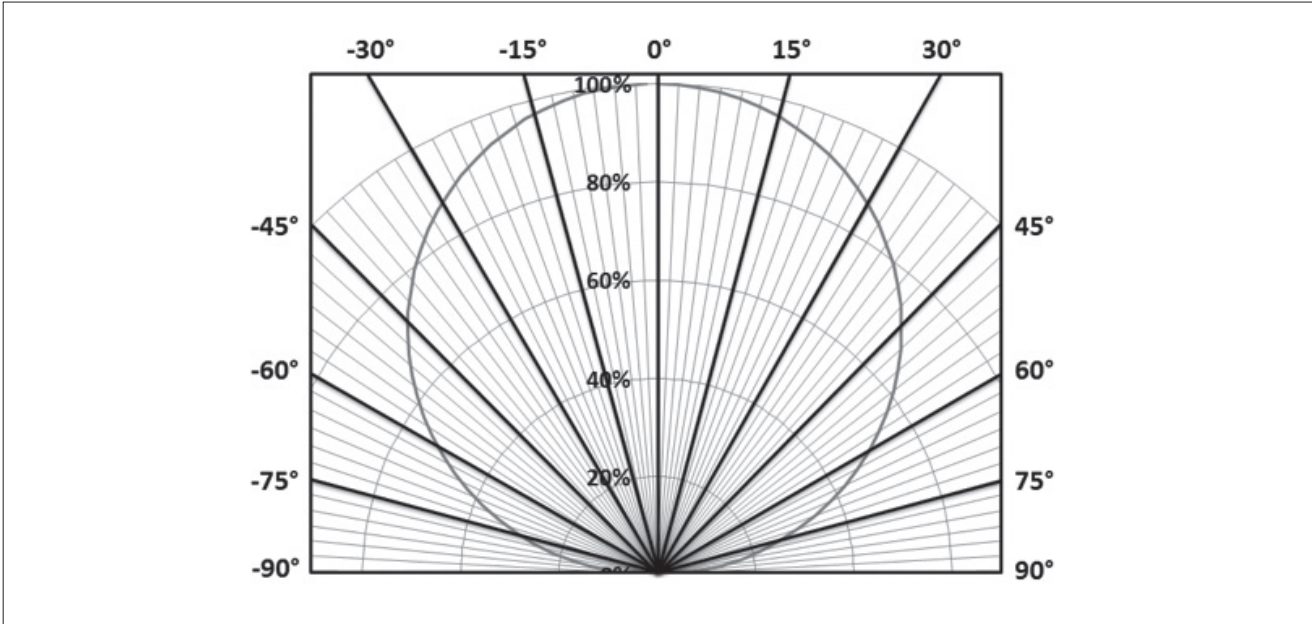

# Typical Color Spectrum

Figure 8: Typical Color Spectrum

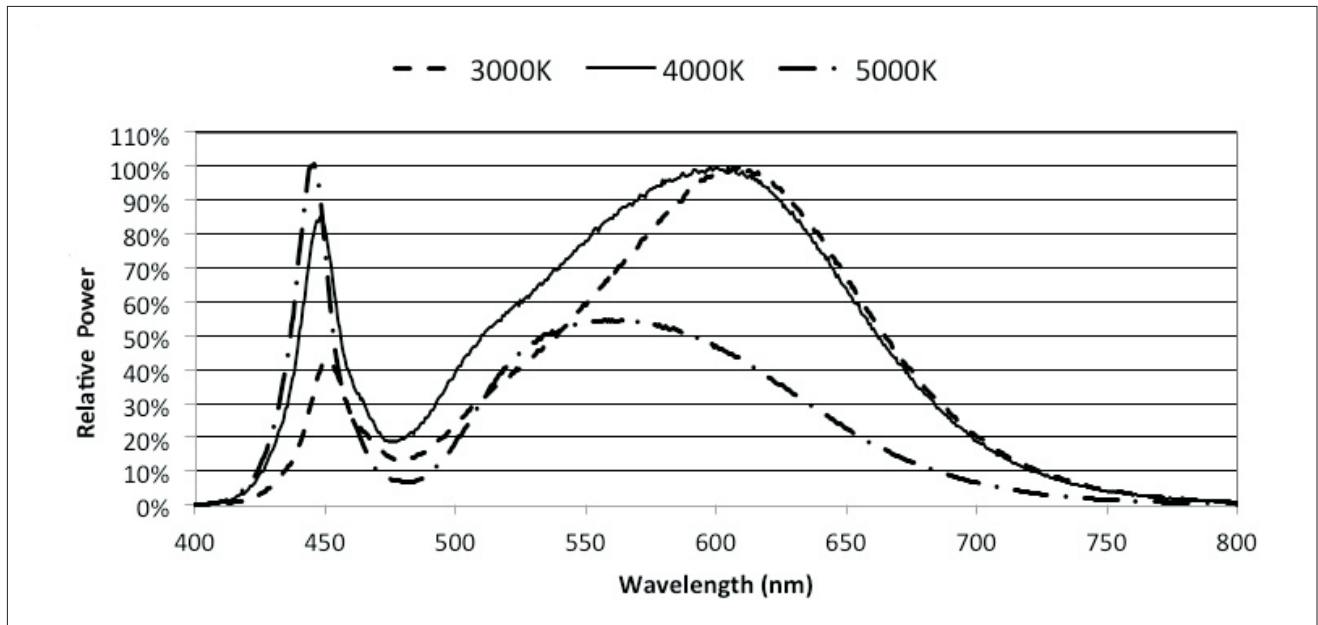

Notes for Figure 8:

1. Color spectra measured at nominal current for  $T_j = T_c = 25^\circ\text{C}$ .
2. Color spectra shown for warm white is 3000K and 80 CRI.
3. Color spectra shown for neutral white is 4000K and 80 CRI.
4. Color spectra shown for cool white is 5000K and 70 CRI.

# Mechanical Dimensions

**Figure 9: Drawing for V13 LED Array**

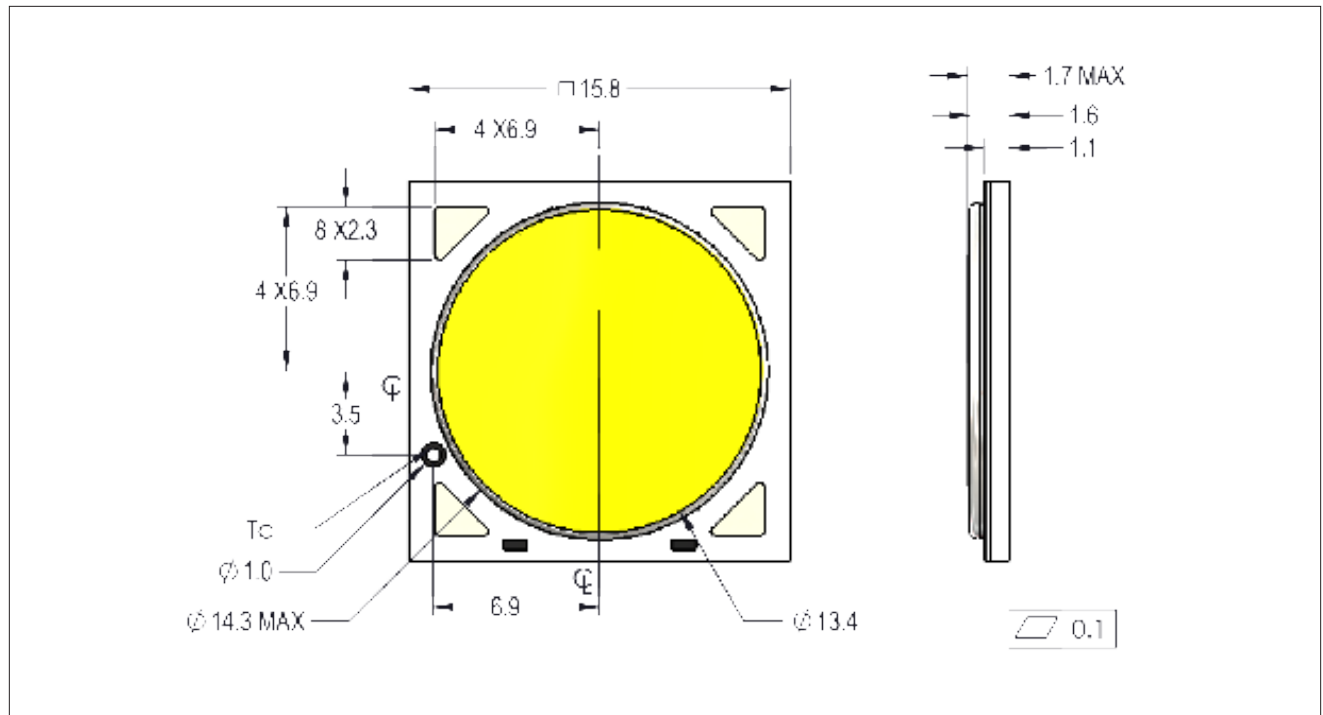

Notes for Figure 9:

1. Solder pads are labeled "+" and "-" to denote positive and negative polarity, respectively.
2. It is not necessary to provide electrical connections to both sets of solder pads. Either set may be used depending on application specific design requirements.
3. Drawings are not to scale.
4. Drawing dimensions are in millimeters.
5. Unless otherwise specified, tolerances are  $\pm 0.10\text{mm}$ .
6. The optical center of the LED Array is nominally defined by the mechanical center of the array. The light emitting surface (LES) is centered on the mechanical center of the array to a tolerance of  $\pm 0.2\text{ mm}$ .
7. Bridgelux maintains a flatness of 0.1 mm across the mounting surface of the array. Refer to Application Notes AN40 and AN41 for product handling, mounting and heat sink recommendations.



# Color Binning Information

**Figure 10: Graph of Warm and Neutral White Test Bins in xy Color Space**

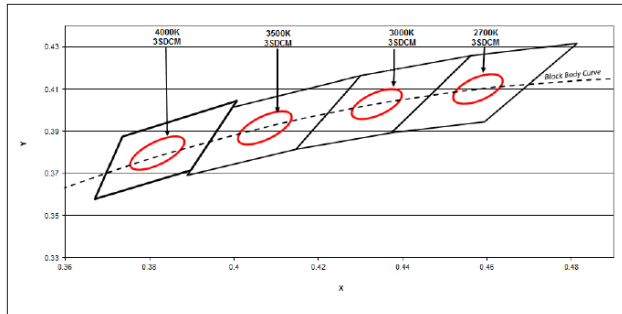

Note: Pulsed Test Conditions,  $T_c = 25^\circ\text{C}$

**Table 7: Warm and Neutral White xy Bin Coordinates and Associated Typical CCT**

Bin Code	2700K	3000K	3500K	4000K
ANSI Bin (for reference only)	(2580K - 2870K)	(2870K - 3220K)	(3220K - 3710K)	(3710K - 4260K)
23 (3SDCM)	(2651K - 2794K)	(2968K - 3136K)	(3369K - 3586K)	(3851K - 4130K)
Center Point (x,y)	(0.4578, 0.4101)	(0.4338, 0.403)	(0.4073, 0.3917)	(0.3818, 0.3797)

**Figure 11: Graph of Cool White Test Bins in xy Color Space**

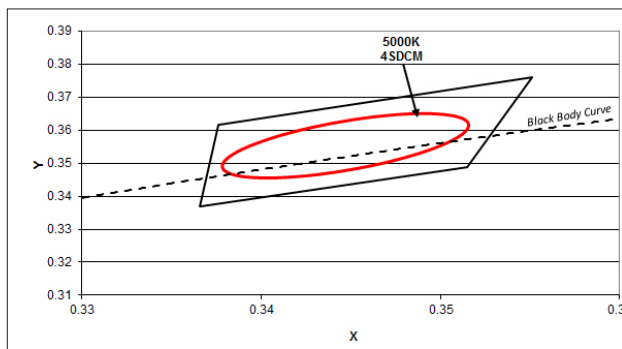

Note: Pulsed Test Conditions,  $T_c = 25^\circ\text{C}$

**Table 8: Cool White xy Bin Coordinates and Associated Typical CCT**

Bin Code	5000K	5600K
ANSI Bin (for reference only)	(4745K - 5311K)	(5310K - 6020K)
24 (4SDCM)	(4801K - 5282K)	(5475K - 5830K)
Center Point (x,y)	(0.3447, 0.3553)	(0.3293, 0.3423)

Note for Tables 7-8:

1. Bridgelux maintains a tolerance of +/- 0.007 on x and y color coordinates in the CIE 1931 color Space.

# Packaging and Labeling

Figure 12: Drawing for V13 Packaging Tray

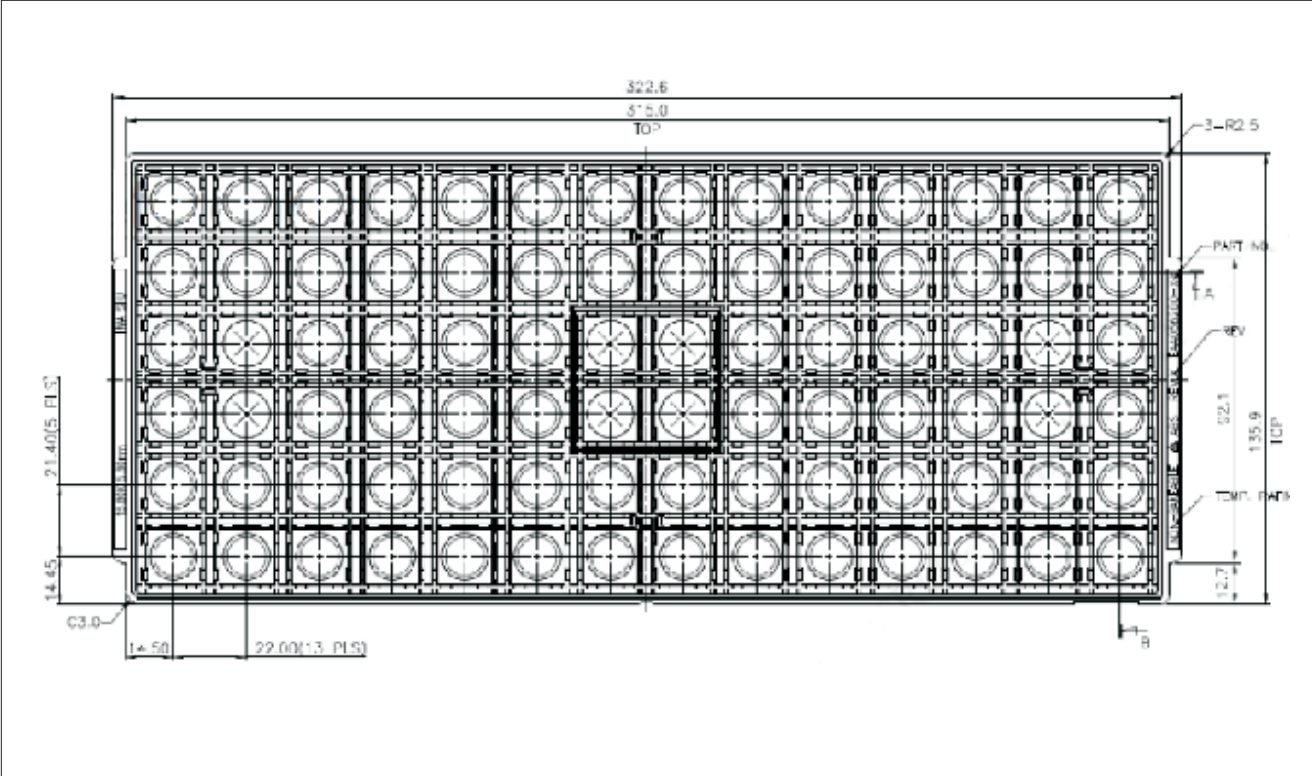

Notes for Figure 12:

1. Dimensions are in millimeters
2. Tolerances: XX = ± 0.25, XXX = ± 0.13, X'0' = ± 0'30'
3. Trays are stackable without interference and will not stick together during unstacking operation

# Packaging and Labeling

**Figure 13: V Series Packaging and Labeling**

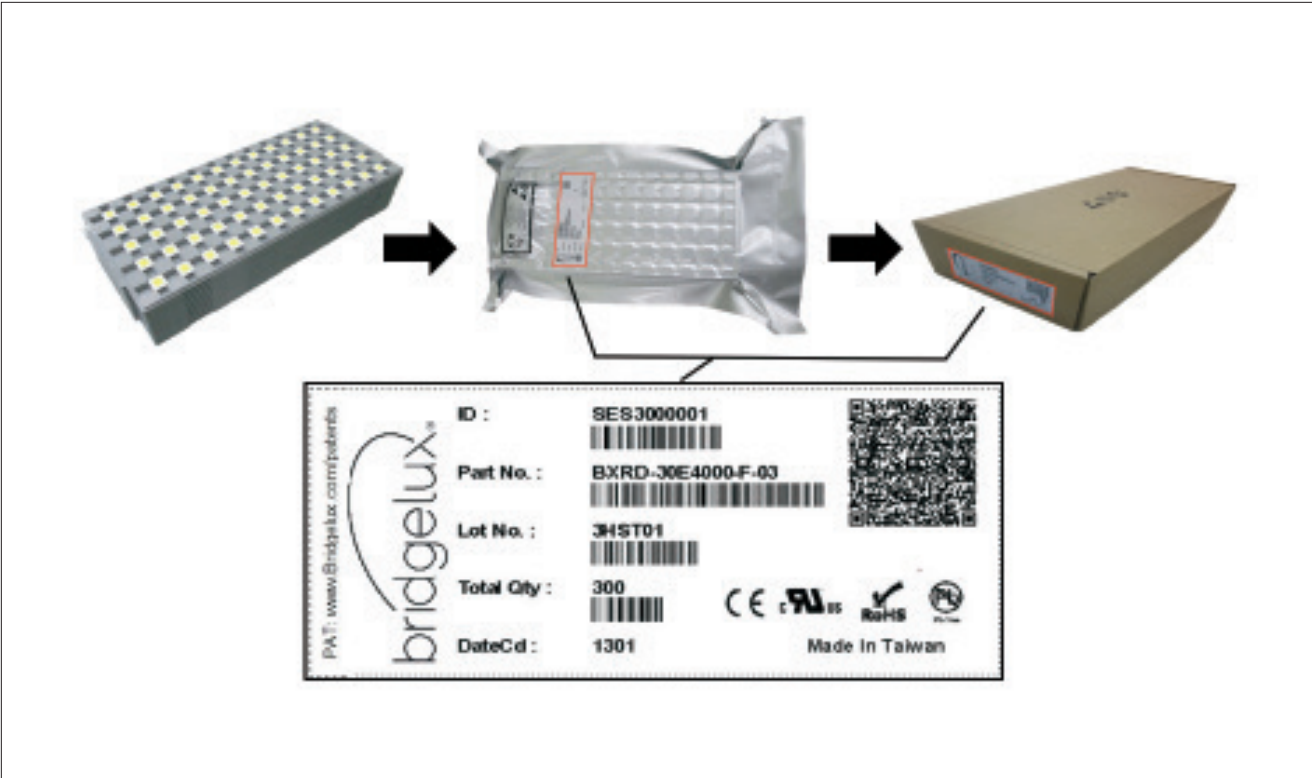

Notes for Figure 13:

1. Each tray holds 84 COB Arrays, 10 trays are stacked and one empty tray placed on top to cover the top tray.
2. Stacked trays are to contain only 1 part number and be vacuum sealed in an anti-static bag and placed in its own individual box.
3. Each bag and box is to be labeled as shown above.

**Figure 14: Product Labeling**

Bridgelux COB arrays have laser markings on the back side of the substrate to help with product identification. In addition to the product identification markings, Bridgelux COB arrays also contain markings for internal Bridgelux manufacturing use only. The image below shows which markings are for customer use and which ones are for Bridgelux internal use only. The Bridgelux internal manufacturing markings are subject to change without notice, however these will not impact the form, function or performance of the COB array.



# Design Resources

## Application Notes

Bridgelux has developed a comprehensive set of application notes and design resources to assist customers in successfully designing with the V Series product family of LED array products. For a list of resources under development, visit [www.bridgelux.com](http://www.bridgelux.com).

## Optical Source Models

Optical source models and ray set files are available for all Bridgelux products. For a list of available formats, visit [www.bridgelux.com](http://www.bridgelux.com).

## 3D CAD Models

Three dimensional CAD models depicting the product outline of all Bridgelux V Series LED arrays are available in both IGS and STEP formats. Please contact your Bridgelux sales representative for assistance.

# Precautions

## CAUTION: CHEMICAL EXPOSURE HAZARD

Exposure to some chemicals commonly used in luminaire manufacturing and assembly can cause damage to the LED array. Please consult Bridgelux Application Note AN41 for additional information.

## CAUTION: EYE SAFETY

Eye safety classification for the use of Bridgelux V Series LED arrays is in accordance with IEC specification EN62471: Photobiological Safety of Lamps and Lamp Systems. V Series LED arrays are classified as Risk Group 1 (Low Risk) when operated at or below the maximum drive current. Please use appropriate precautions. It is important that employees working with LEDs are trained to use them safely.

## CAUTION: RISK OF BURN

Do not touch the V Series LED array. Allow the array to cool for a sufficient period of time before handling. The V Series LED array may reach elevated temperatures such that could burn skin when touched.

## CAUTION

### CONTACT WITH LIGHT EMITTING SURFACE (LES)

Avoid any contact with the LES. Do not touch the LES of the LED array or apply stress to the LES (yellow phosphor resin area). Contact may cause damage to the LED array.

Optics and reflectors must not be mounted in contact with the LES (yellow phosphor resin area). Use the mechanical features of the LED array housing, edges and/or mounting holes to locate and secure optical devices as needed.

# Disclaimers

## MINOR PRODUCT CHANGE POLICY

The rigorous qualification testing on products offered by Bridgelux provides performance assurance. Slight cosmetic changes that do not affect form, fit, or function may occur as Bridgelux continues product optimization.

## STANDARD TEST CONDITIONS

Unless otherwise stated, array testing is performed at the nominal drive current.

# About Bridgelux: We Build Light That Transforms

At Bridgelux, we help companies, industries and people experience the power and possibility of light. Since 2002, we've designed LED solutions that are high performing, energy efficient, cost effective and easy to integrate. Our focus is on light's impact on human behavior, delivering products that create better environments, experiences and returns—both experiential and financial. And our patented technology drives new platforms for commercial and industrial luminaires.

**For more information about the company, please visit**  
**bridgelux.com**  
**twitter.com/Bridgelux**  
**facebook.com/Bridgelux**  
**WeChat ID: BridgeluxInChina**



101 Portola Avenue  
Livermore, CA 94551  
Tel (925) 583-8400  
Fax (925) 583-8410  
**www.bridgelux.com**

© 2016 Bridgelux, Inc. All rights reserved 2016. Product specifications are subject to change without notice. Bridgelux, the Bridgelux stylized logo design and V Series are registered trademarks, and Decor Series is a trademark of Bridgelux, Inc. All other trademarks are the property of their respective owners.

**Bridgelux V13 Array Series Product Data Sheet DS44 Rev. F (09/2021)**